

ASSEMBLY INSTRUCTIONS FOR BED

Step 1

Place headboard against the wall and insert half of bolts, do not tighten the bolts.

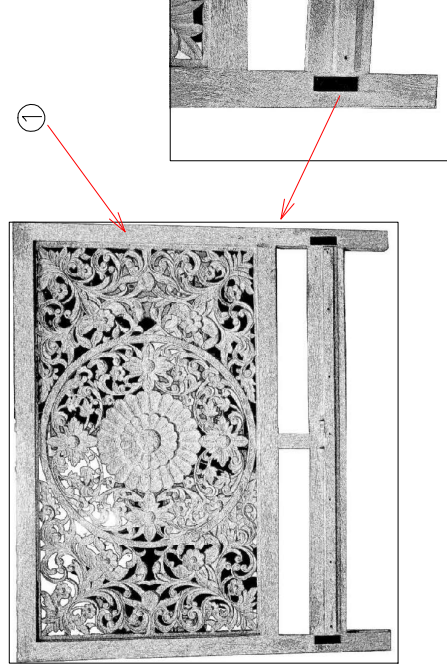

Step 2

Match the label on side rail with headboard & footboard ("A"- "A") & place the side rails on headboard with footboard & tighten the bolts. Similarly attached other side & footboard.

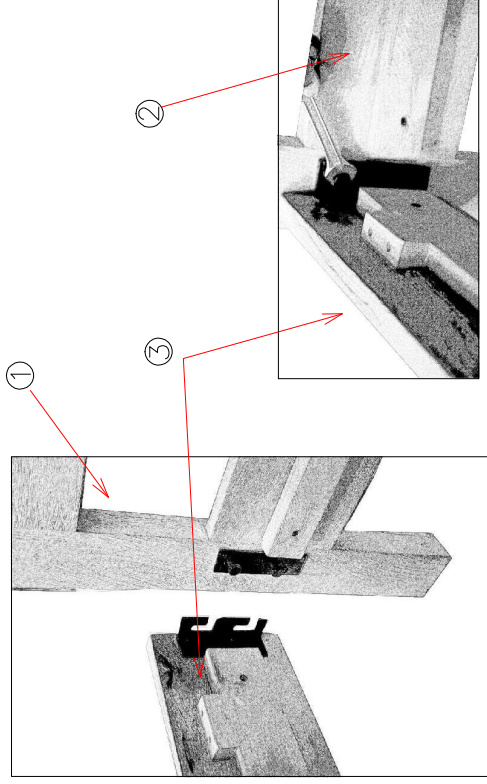

Step 3

Middle leg Attach to center support. Similarly match the headboard & footboard label with center support & fix the center support.

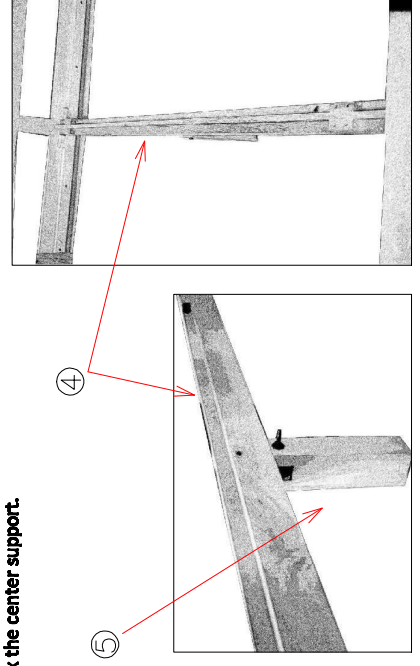

Step 4

Place the slats between center support & side rail.

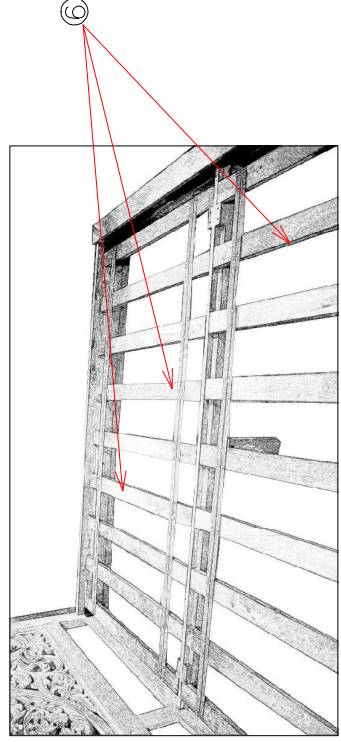

ASSEMBLY INSTRUCTIONS FOR BED

ASSEMBLED VIEW

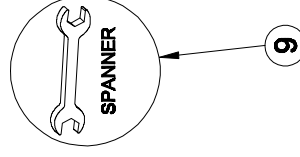
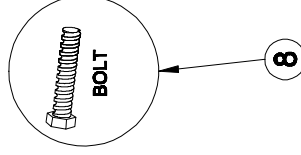
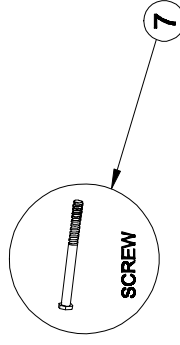
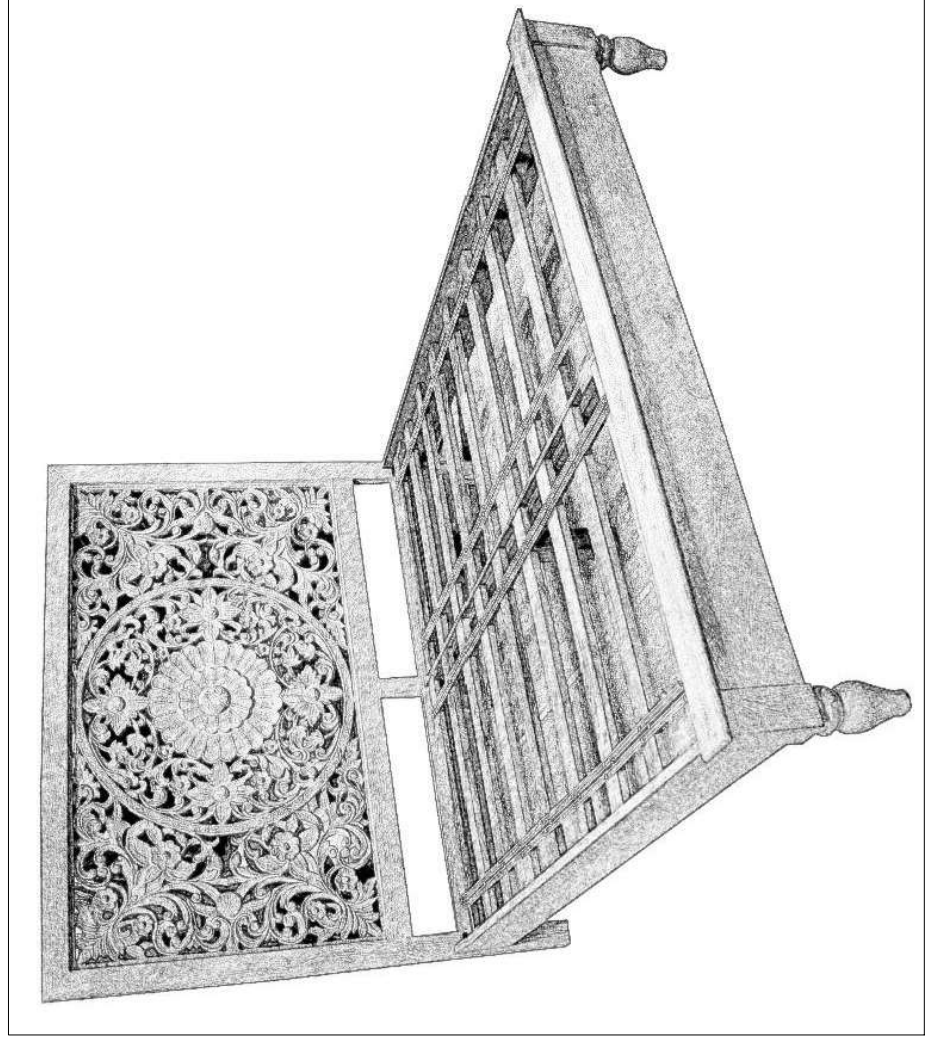

S.No.	PART LIST	QTY.
1.	HEAD BOARD	1Pc.
2.	FOOTBOARD	1Pc.
3.	SIDE RAIL	2Pc.
4.	CENTER SUPPORT	1Pc.
5.	CENTER LEG	1Pc.
6.	WOODEN SLAT	2 Set
7.	BOLT & NUT	1Pc.
8.	BOLT	8Pc.
9.	Spanner	1Pc.