

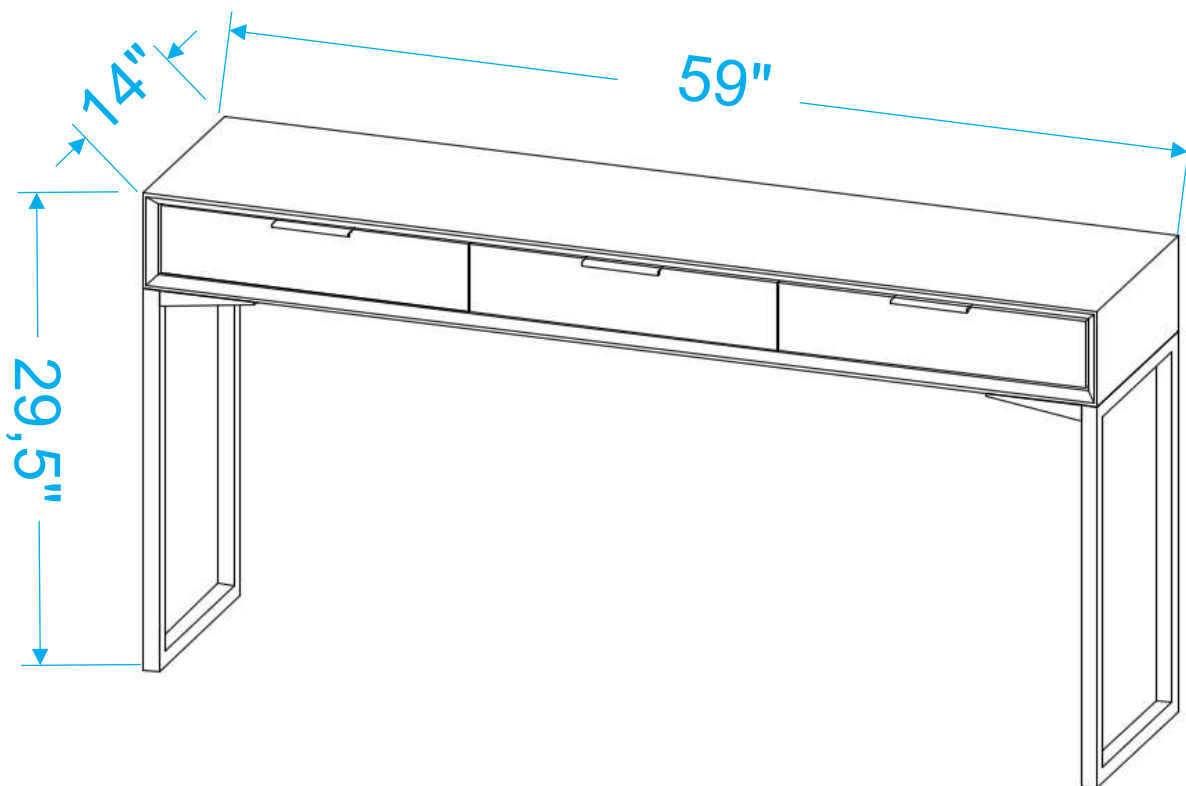



PESCE SHAGREEN CONSOLE

PESCE



ASSEMBLY INSTRUCTIONS







PARTS LIST

LABEL	PICTURE	DESCRIPTION	QTY.
A		BODY	1
B		LEG	2

HARDWARE

LABEL	PICTURE	DESCRIPTION	QTY.
C		Bolt M6X20	16
D		Wrench M4X60	1
E		Washer	16

BEFORE BEGINNING ASSEMBLY:

-  Read instructions cover to cover
-  Have two adults on hand for assembly
-  Do NOT assemble on flooring or carpet. Assemble on a clean non-marring surface (ex: packing foam)
-  Save all packaging until assembly is completed

ASSEMBLY STEPS

STEP 1

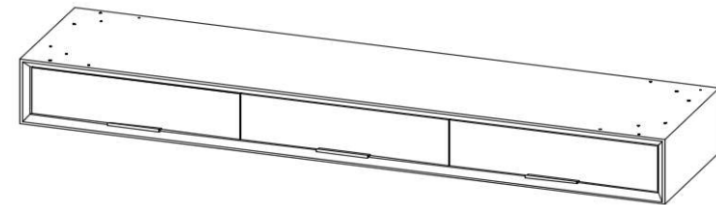

› Position the product on its bottom as shown.

STEP 2

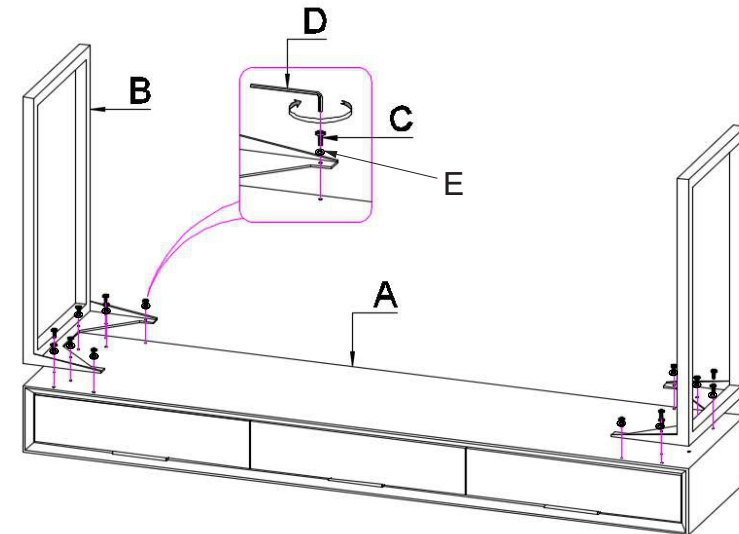

CARE & MAINTENANCE



Do not put hot items directly on furniture surface.



Do not clean furniture with harsh cleansers or polish



Dust and wipe up spills using a clean, non-colored, lint-free cloth.



Stains may be removed with mild soap solution and a damp cloth.



Do not place furniture under direct sunlight.



Do not place furniture near heating or cooling vents.



Do not write on furniture without a padded barrier to protect the surface.



Do not place furniture outside, for indoor use only.

**"Need a part? Call TOV at 516-888-3355 or
email service@tovfurniture.com"**