

T Ö V

FURNITURE



Cloud Velvet Setee
TOV-L6161

CLOUD

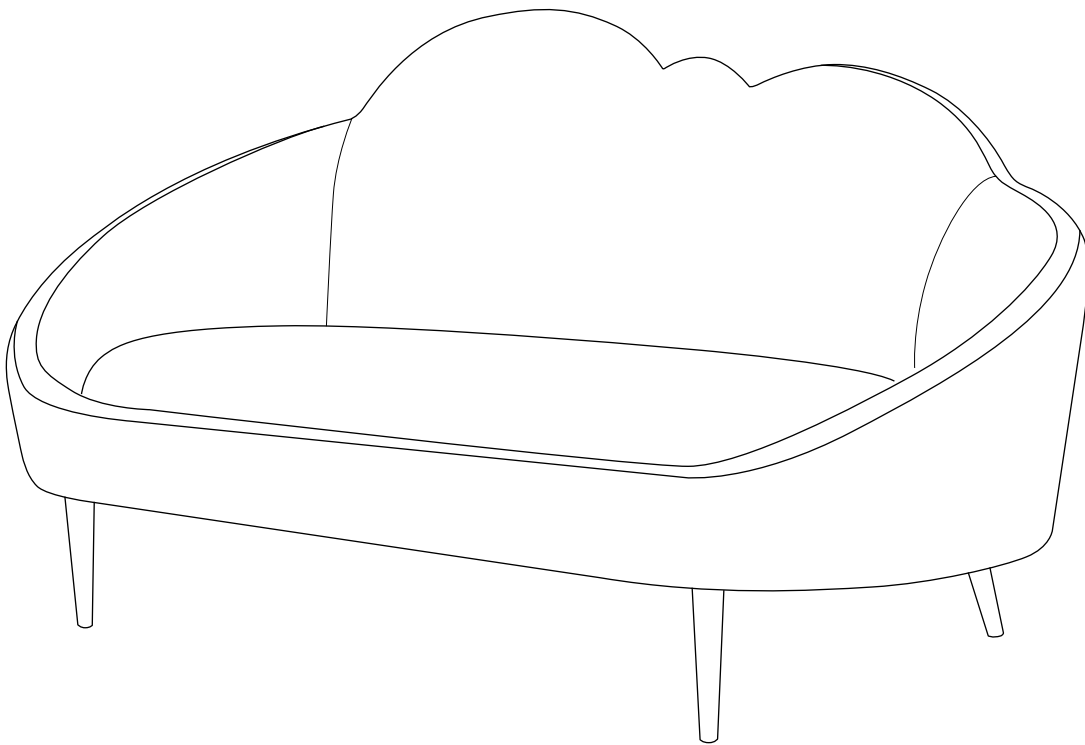

Assembly Instructions



PARTS LIST

LABEL	PICTURE	DESCRIPTION	QTY
A		Setee	1
B		Front Legs	2
C		Back Legs	2

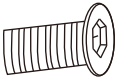
HARDWARE

LABEL	PICTURE	DESCRIPTION	QTY
a		Metal Gasket	12
b		Screw	12
c		Wrench	1

BEFORE BEGINNING ASSEMBLY:



Read instructions cover to cover



Have two adults on hand for assembly



Do NOT assemble on flooring or carpet. Assemble on a clean non-marring surface (ex: packing foam)



Save all packaging until assembly is completed

ASSEMBLY STEPS

STEP 1

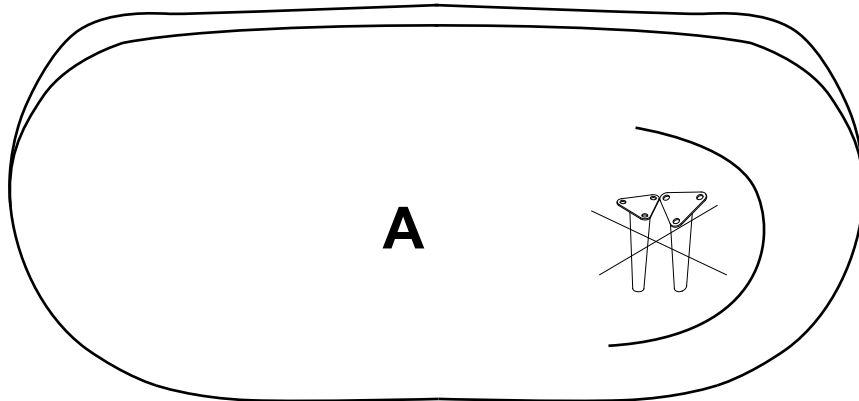

- > Position setee on its side with the bottom facing outwards.
- > Open compartment to remove legs.

STEP 2

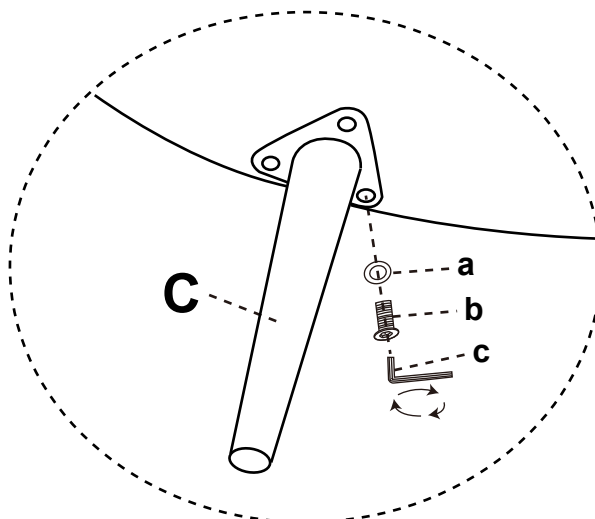
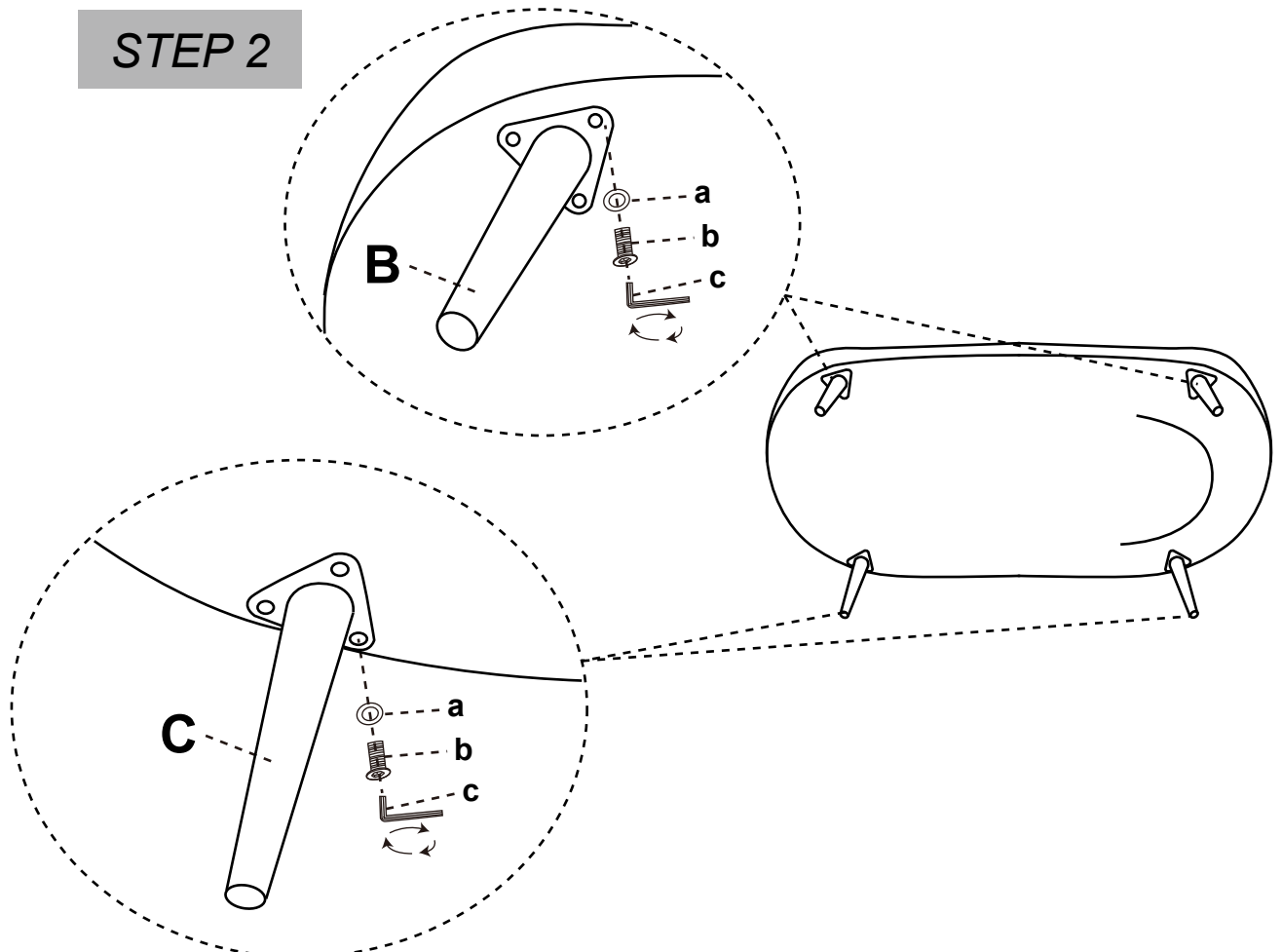

CARE & MAINTENANCE



Do not put hot items directly on furniture surface.



Do not clean furniture with harsh cleansers or polish.



Dust and pick up spills using a clean, non-colored, lint-free cloth.



Stains may be removed with mild soap solution and a damp cloth.



Do not place furniture under direct sunlight.



Do not place furniture near heating or cooling vents.



Do not write on furniture without a padded barrier to protect the surface.



Do not place furniture outside, for indoor use only.

MATERIAL CARE INSTRUCTIONS

Fabric

Clean regularly with a vacuum cleaner. Do not use any solvent containing a cleaning agent. Remove spilled liquids immediately in the direction of seam to seam. Use distilled/purified water to avoid chalk stains.

Glass

Clean with a glass cleaner. Never use abrasive detergents. Use table mats on the surface to avoid scratches from forming.

Metal

For regular cleaning, use a slightly wet cloth and immediately dry. You may periodically use special cleaning agents, especially for chrome or copper materials.

Polished Marble and Stone

Quarried stone or marble contains natural fissures along with color variations. These are not considered defects as they enhance the look and the uniqueness of the item. As hard as stone or marble is, the surface is still porous and might stain from liquids or foods. Glass cleaner or soap and water may be used to maintain the stone or marble surfaces. As a recommendation, we suggest polishing these materials with clean wax. For best results use a polisher product which contains carnauba wax. This type of wax is readily available from your local home improvement store. Waxing often will help protect the surface from stains caused by water or liquids. Please note that applying wax prior to use with foods or liquids is highly recommended.

Synthetic Leather

Dust off regularly and use a slightly wet sponge periodically. Use light soapy water to remove stains. Persistent stains can be removed by carefully using cleaning solvents. Always clean in the direction of seam to seam.

Solid Wood

As wood is a hygroscopic natural product, it may shift in various temperature or humidity, depending on the type of wood, construction, and place of location. Optimum conditions are 64-70°F (18-21 °C), with the humidity of 45-55%.

Untreated and Lacquered Wood

Dust off regularly. Use slightly wet cloth once in a while. Clean in the direction of the wood texture. Avoid stagnant moisture.

Oiled, Bleached, and Waxed Wood

Dust off regularly with a damp cloth. Protect and clean with paraffin oil-based products.

Wood Laminated or Coated with Melamine Resin

Use antistatic dusters for daily care. Use lukewarm suds to remove light staining. Do not use abrasive detergents, any wax, or furniture polish. Melamine resin can be cleaned best with cleaning solvents in combination with a chamois leather.