

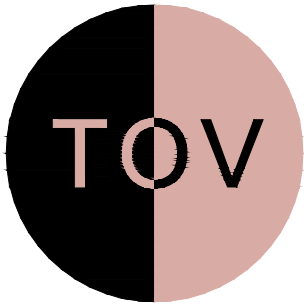

SADIE VANITY DESK

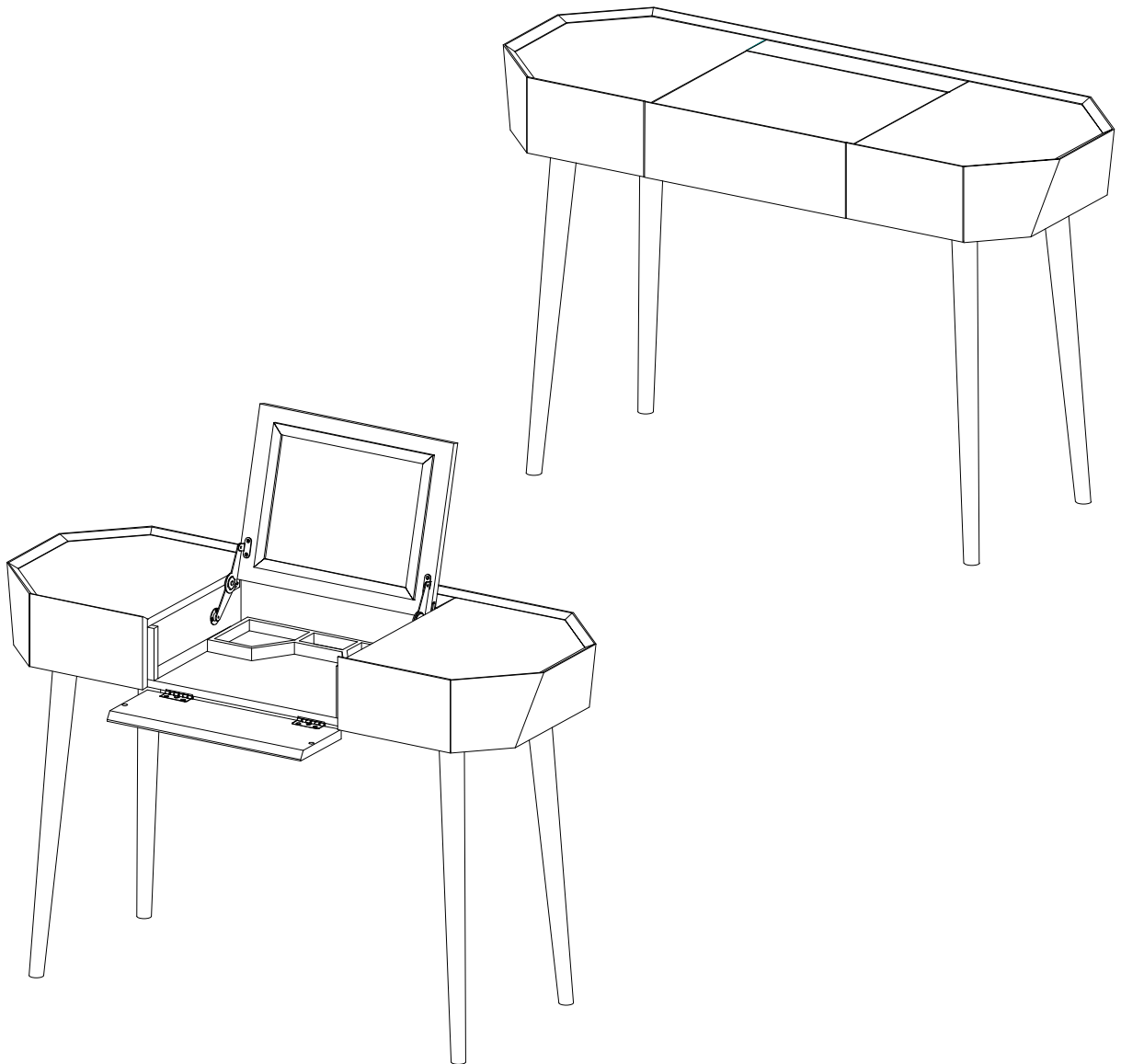



SADIE VANITY DESK ASSEMBLY INSTRUCTIONS

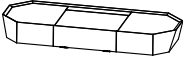

PARTS LIST

LABEL	PICTURE	DESCRIPTION	QTY
A		VANITY DESK	1
B		LEGS	4

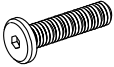
HARDWARE

LABEL	PICTURE	DESCRIPTION	QTY
C		Bolt M8x20	16
D		Washer Ø19xØ8x1mm	16
E		Wrench M4x60	1

BEFORE BEGINNING ASSEMBLY:



Read instructions cover to cover



Have two adults on hand for assembly



Do NOT assemble on flooring or carpet. Assemble on a clean non-marring surface (ex: packing Foam)



Save all packaging until assembly is completed

Lock Washer

ASSEMBLY STEPS

STEP 1

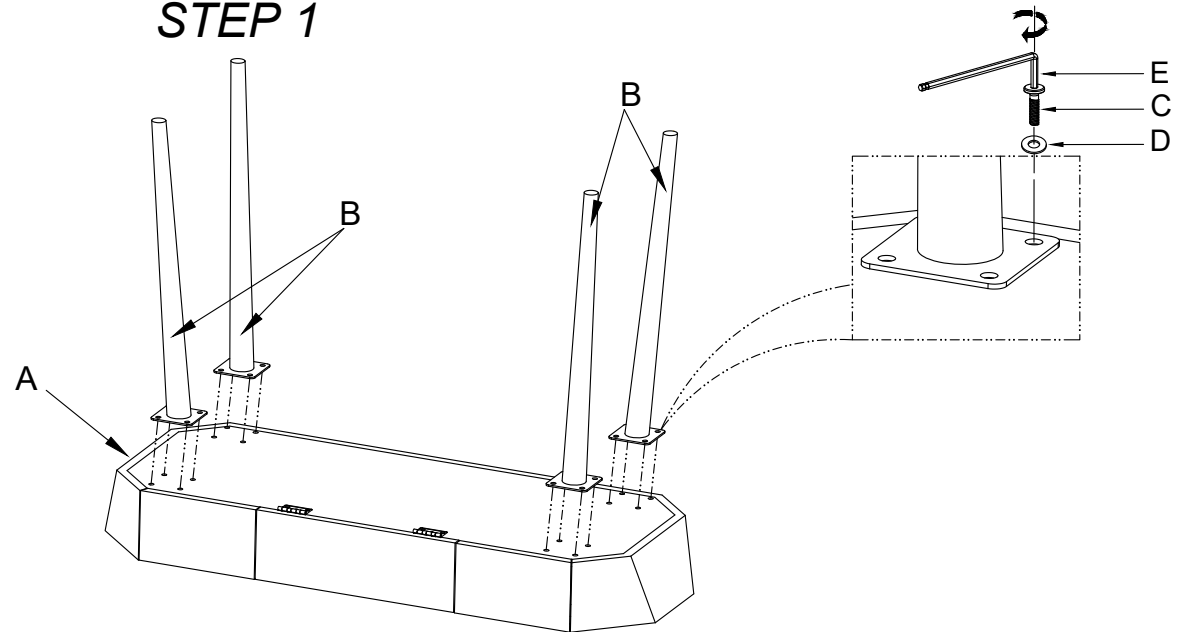

Using the included hardware, attach the legs to the desk as illustrated

STEP 2

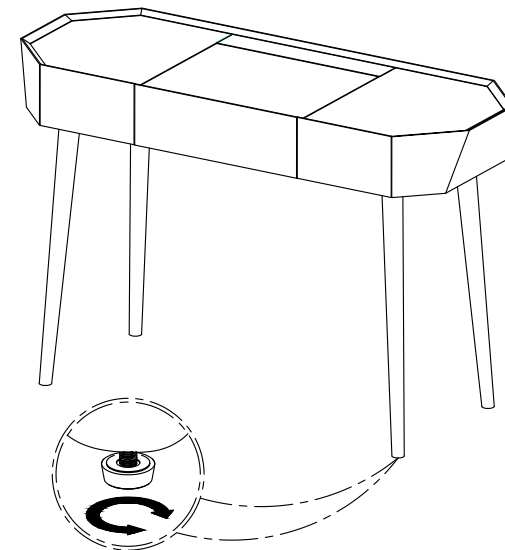

The floor glides can be adjusted to ensure the table's stability

CARE & MAINTENANCE



Do not put hot items directly on furniture surface.



Do not clean furniture with harsh cleansers or polish



Dust and wipe up spills using a clean, non-colored, lint-free cloth.



Stains may be removed with a mild soap solution and a damp cloth.



Do not place furniture under direct sunlight.



Do not place furniture near heating or cooling vents.



Do not write on furniture without a padded barrier to protect the surface.



Do not place furniture outside, for indoor use only.

**"Need a part? Call TOV at 516-888-3355 or
email service@tovfurniture.com"**