

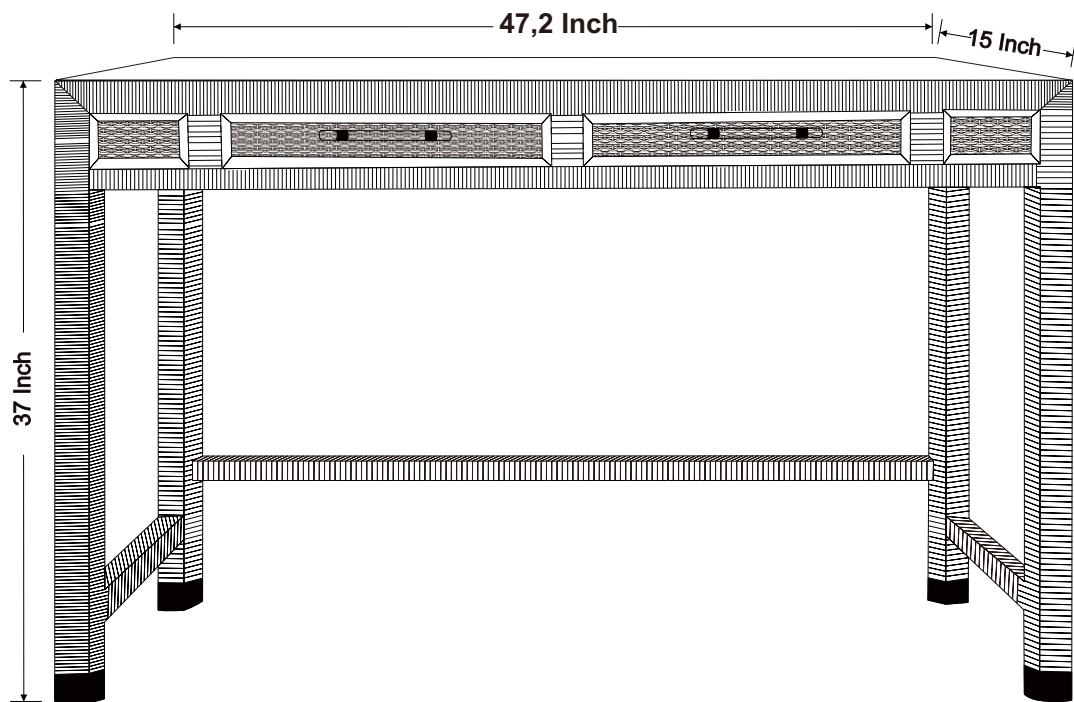





AMARA RATTAN DESK





ASSEMBLY INSTRUCTIONS

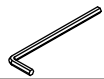

ASSEMBLY INSTRUCTIONS.

AMARA RATTAN DESK

PART LIST.			
LABEL.	PICTURE.	DESCRIPTIONS.	QTY.
1		TOP	1
2		RIGHT LEG	1
3		LEFT LEG	1
4		SUPPORT BAR	1

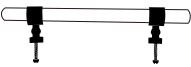
HARDWARE LIST.			
LABEL.	PICTURE.	DESCRIPTIONS.	QTY.
A		- L WRENCH	1
B		- WASHER	10
C		- BOLT M4 - 12	8
D		- BOLT M6 - 12	2
E		- BRASS COVER	2
F		- HANDLE	2

BEFORE BEGINNING ASSEMBLY:



Read instructions cover to cover.



Have two adults on hand for assembly.



Do not assemble on flooring or carpet. Assemble on a clean not-marring surface (ex: packing foam).



Save all packaging until assembly is completed.

ASSEMBLY INSTRUCTIONS.

STEP 01

1.) Attach the legs to the desktop using the included hardware as shown

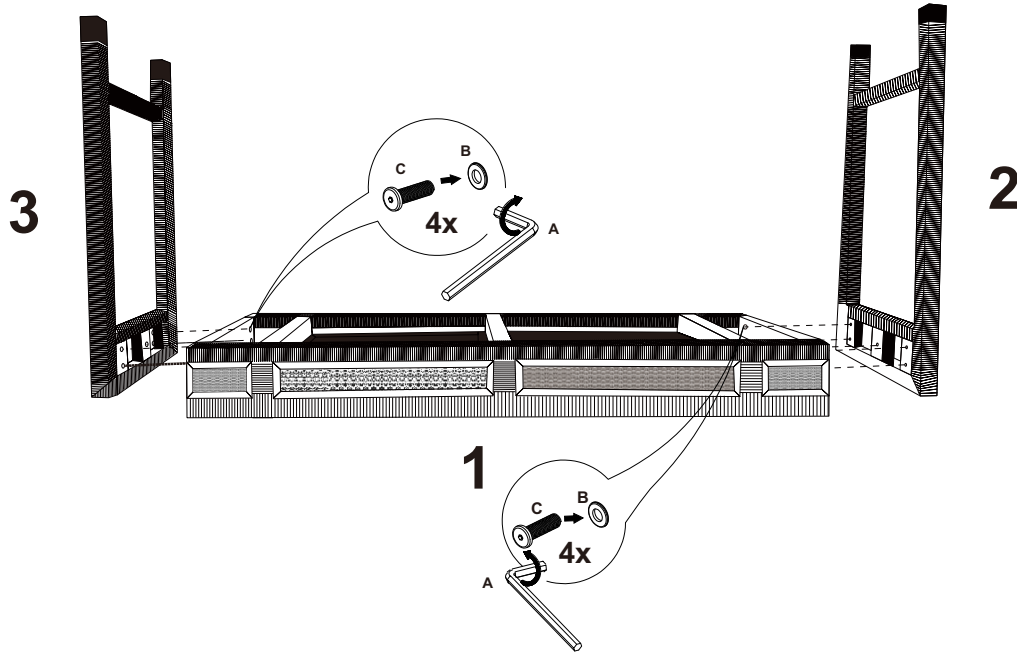

STEP 02

2.) Secure the support bar to the two legs with the included hardware

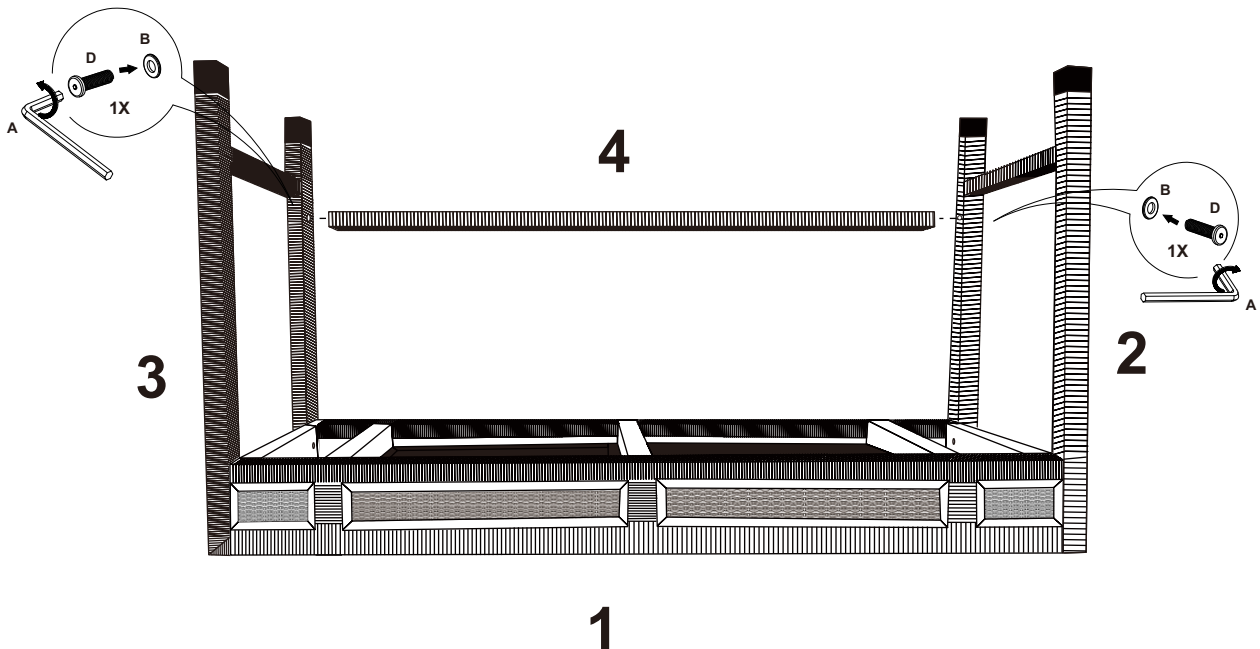

ASSEMBLY INSTRUCTIONS.

STEP 03

3.) Attach the two brass leg covers as shown

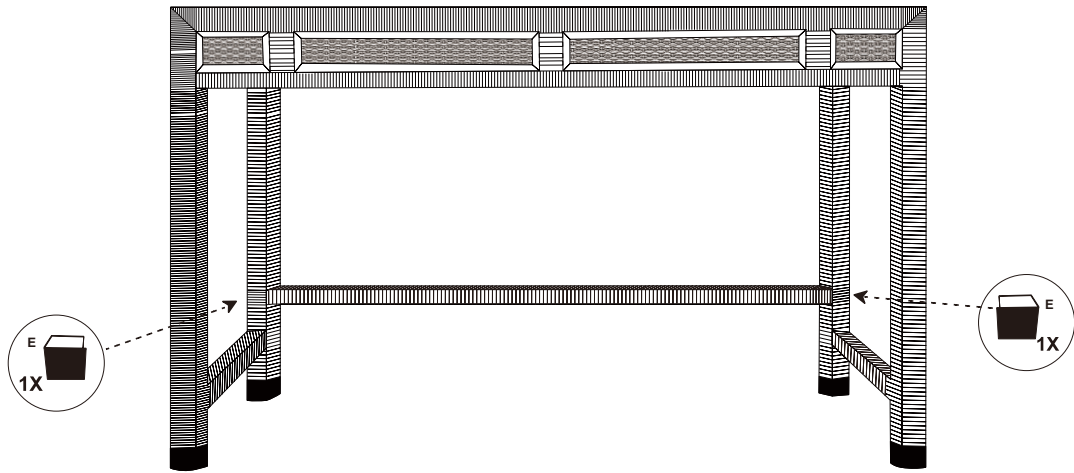

STEP 04

4.) Remove the handles from the inside of the drawer and reattach them to the outside of the drawers

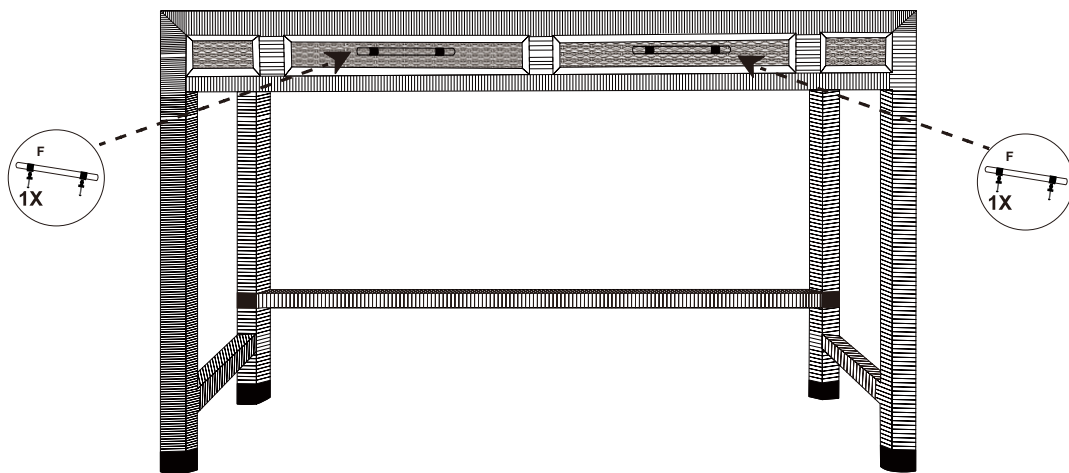

COMPLETE

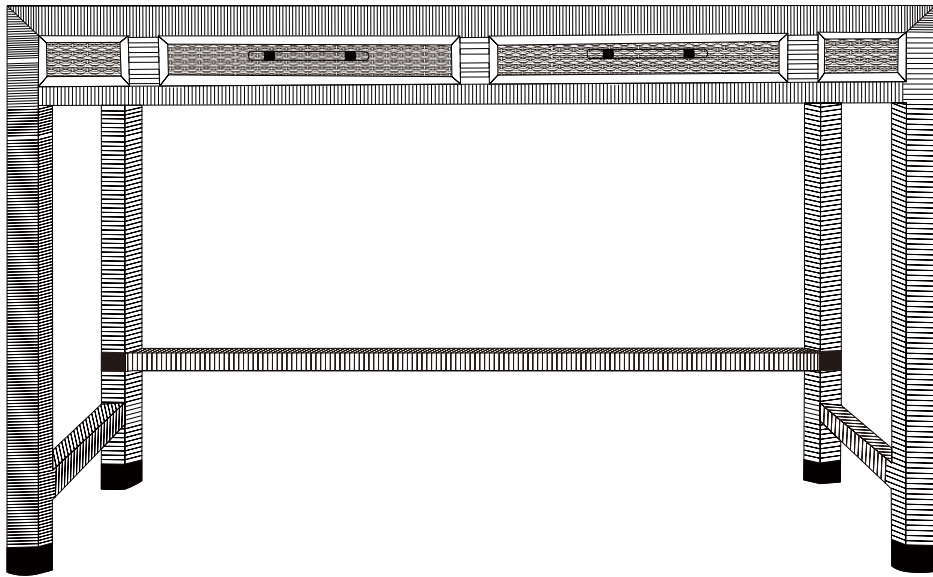

CARE & MAINTENANCE.



Do not put hot items directly on furniture surface.



Do not clean furniture with harsh cleansers or polish



Dust and wipe up spills using a clean, non-colored, lint-free cloth.



Stains may be removed with a mild soap solution and a damp cloth.



Do not place furniture under direct sunlight.



Do not place furniture near heating or cooling vents.



Do not write on furniture without a padded barrier to protect the surface.



Do not place furniture outside, for indoor use only.

**"Need a part? Call TOV at 516-888-3355 or
email_service@tovfurniture.com"**