

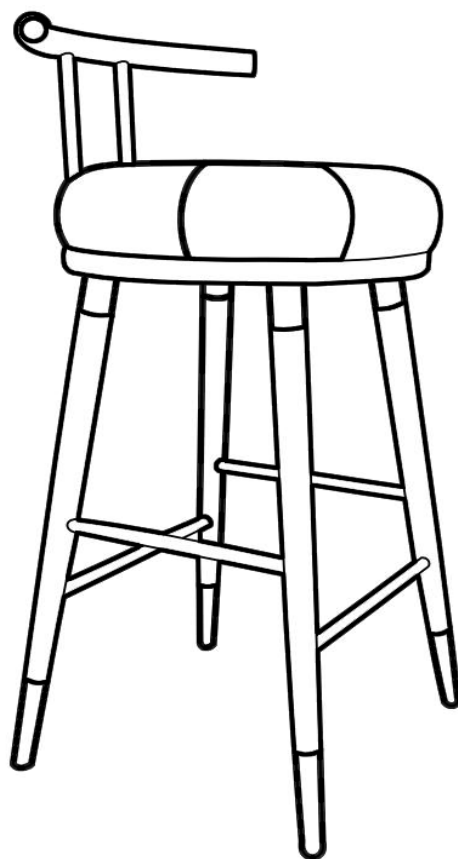

Juniper Stool

Juniper





ASSEMBLY INSTRUCTIONS

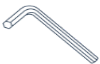

PARTS LIST

LABEL	PICTURE	DESCRIPTION	QTY
A		STOOL	1
B		BACKREST	1

HARDWARE LIST

LABEL	PICTURE	DESCRIPTION	QTY
		Allen Key	1
		Bolt(M6*30mm)	4
		Spring Washer	4
		Washer	4

BEFORE BEGINNING ASSEMBLY:



Read instructions cover to cover



Have two adults on hand for assembly



Do NOT assemble on flooring or carpet. Assemble on a clean non-marring surface (ex : packing foam)



Save all packaging until assembly is completed

Need a part? Call TOV at 516-888-3355 or email service@tovfurniture.com

ASSEMBLY STEPS

STEP 1

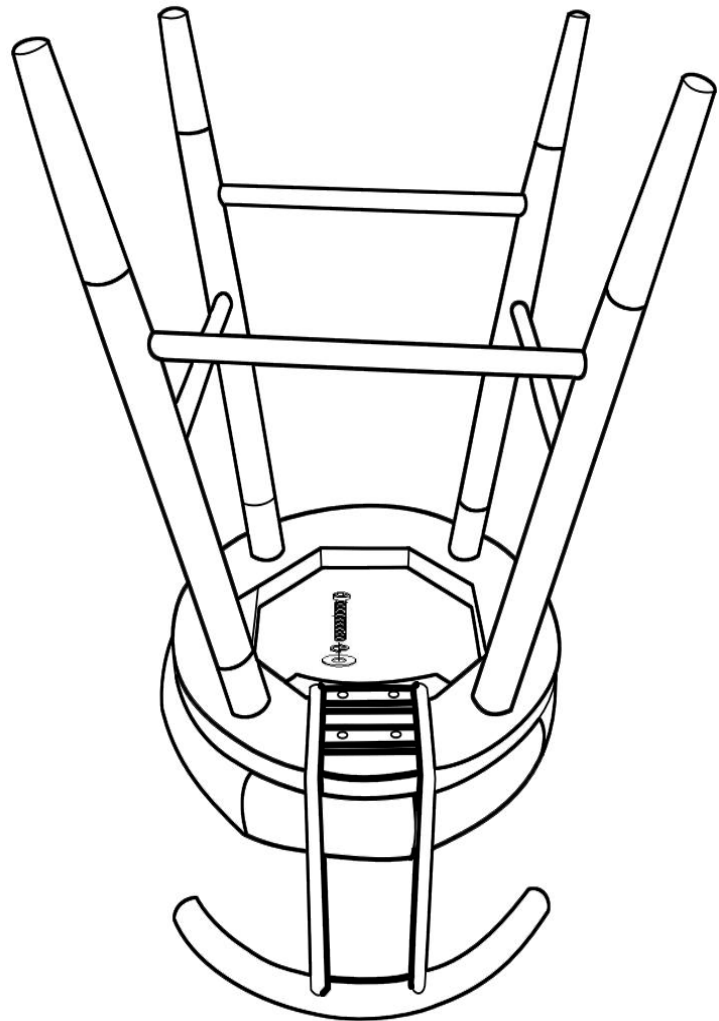
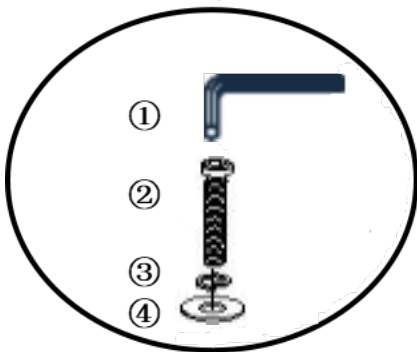
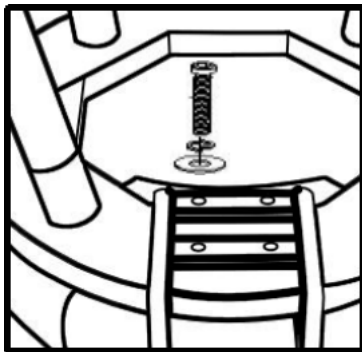

› Place the Backrest(B) on the Stool(A) as illustrated.
Align and fasten the backrest(B) to the Stool(A) using the included Bolts (), Spring Washers() and Washers() with the included Allen key().

STEP 2

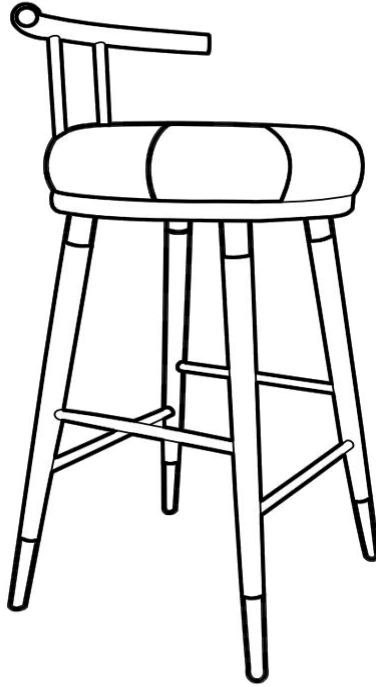

> Set the stool upright and assembly is complete.

CARE & MAINTENANCE



Do not put hot items directly on furniture surface.



Do not clean furniture with harsh cleansers or polish.



Dust and pick up spills using a clean, non-colored, lint-free cloth.



Stains may be removed with mild soap solution and a damp cloth.



Do not place furniture under direct sunlight.



Do not place furniture near heating or cooling vents.



Do not write on furniture without a padded barrier to protect the surface.



Do not place furniture outside, for indoor use only.