

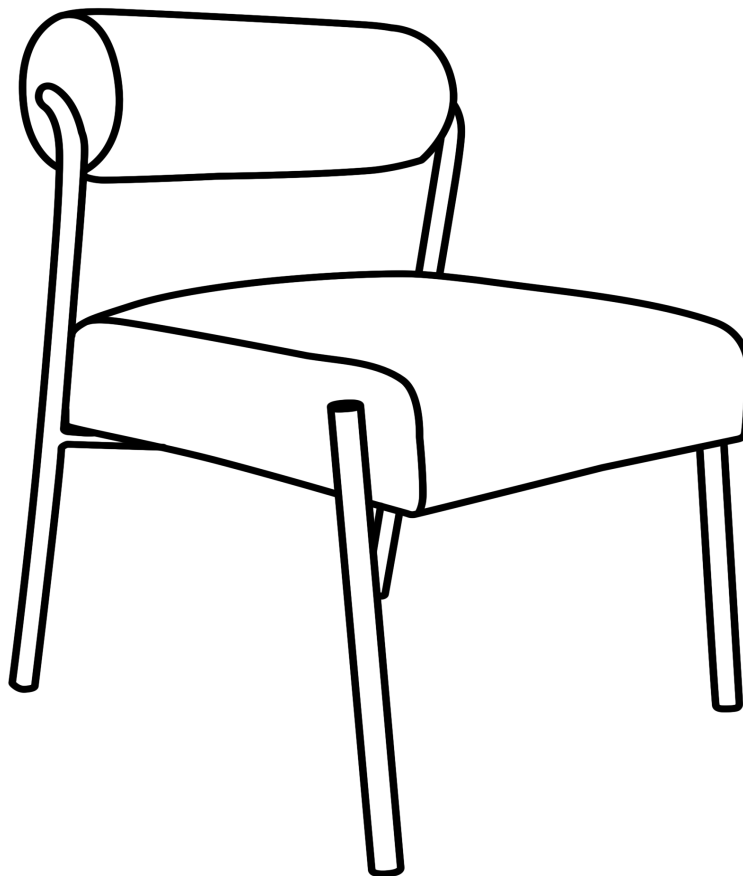

Jolene Dining Chair





JOLENE ASSEMBLY INSTRUCTIONS

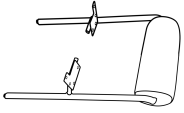
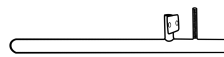
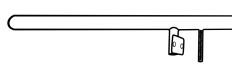

PARTS LIST

LABLE	PICTURE	DESCRIPTION	QTY
A		Chair Seat	1
B		Backrest and legs	1
C		Front Legs (Left)	1
D		Front Legs (Right)	1

HARDWARE

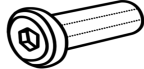
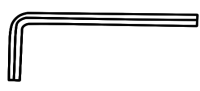
LABLE	PICTURE	DESCRIPTION	QTY
E		Screw(M8*30)	12
F		Spring Washer	12
G		Metal Gasket(M8)	12
H		Metal Gasket(M12)	2
K		Screw(M8*30)	2
H		Allen Key	1

BEFORE BEGINNING ASSEMBLY:



Read instructions cover to cover



Have two adults on hand for assembly



DO NOT assemble on flooring or carpet. Assemble on a clean non-marring surface(ex: packing foam)



Save all packaging until assembly is completed

Need a part? Call TOV at 516-888-3355 or email service@tovfurniture.com

ASSEMBLY STEPS

STEP 1

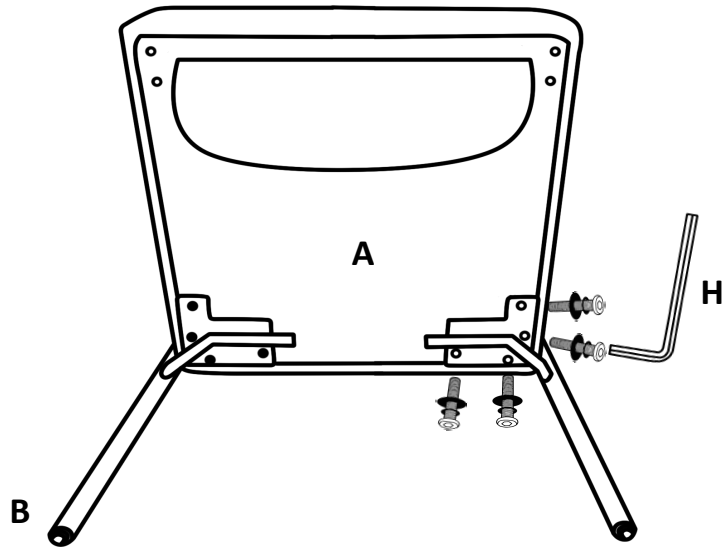
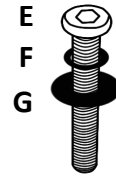

› Attach the backrest (B) to the seat (A) as illustrated

STEP 2

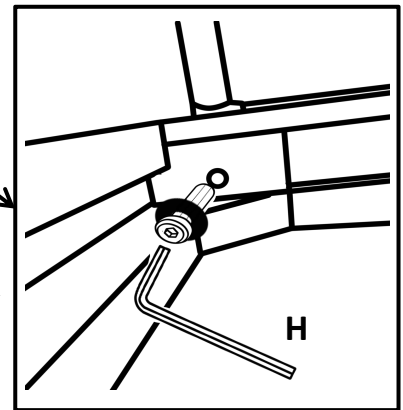
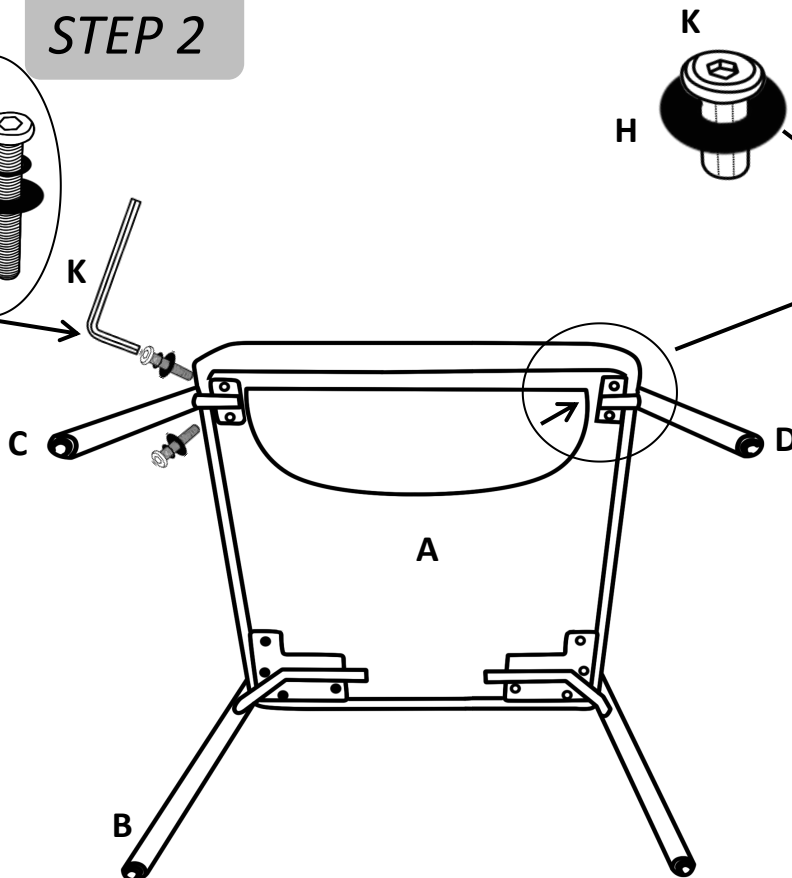
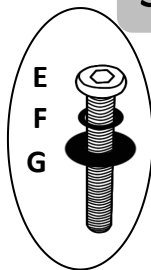

› Attach the Front Legs (C) and (D) to the seat (A) as illustrated

› Tighten all screws. Assembly is completed.

CARE & MAINTENANCE



Do not put hot items directly on furniture surface



Do not clean furniture with harsh cleansers or polish.



Dust and pick up spills using a clean, non-colored, lint-free cloth.



Stains may be removed with a mild soap solution and a damp cloth.



Do not place furniture under direct sunlight.



Do not place furniture near heating or cooling vents.



Do not write on furniture without a padded barrier to protect the surface.



Do not place furniture outside, for indoor use only.