

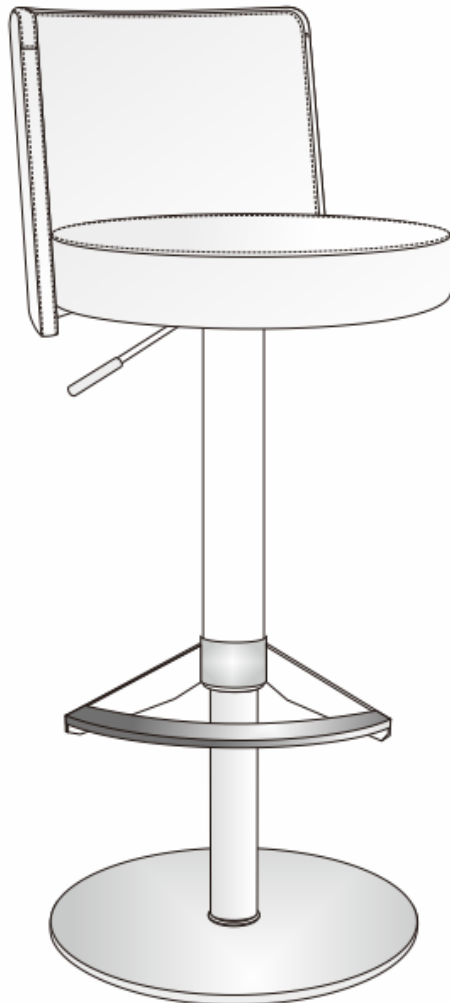



**Loosha Barstool**

# Loosha



## ASSEMBLY INSTRUCTIONS



# Parts List

Label	Picture	Description	QTY
A		Seat	1
B		Metal Base	1
C		Handle	1

## Hardware

Label	Picture	Description	QTY
D		Screw 6x25 MM	2
E		Screw 6x16 MM	2
F		Spanner (M5)	1

### **BEFORE BEGINNING ASSEMBLY:**



*Read instructions cover to cover*



*Have two adults on hand for assembly*



*Do NOT assemble on flooring or carpet. Assemble on a clean non-marring surface (ex: packing foam)*



*Save all packaging until assembly is completed*

# Assembly Steps

## Step 1

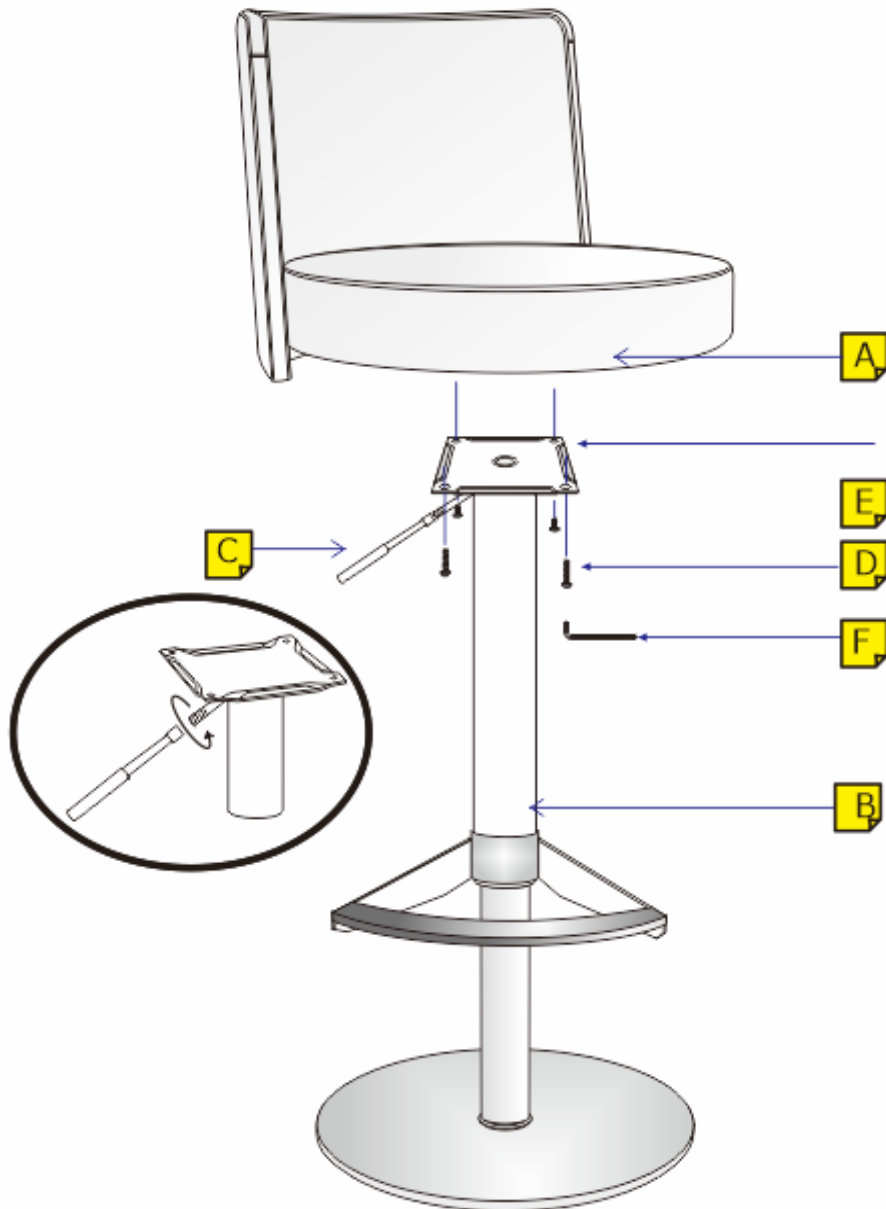

In order to activate the gas hydraulic, it is important that once you have assembled the stool that you raise the lever and bounce your weight up and down on the stool and then lift your weight off with the lever still raised and the stool should begin to rise.

"Need a part? Call TOV at 516-888-3355 or email [service@tovfurniture.com](mailto:service@tovfurniture.com)"

