

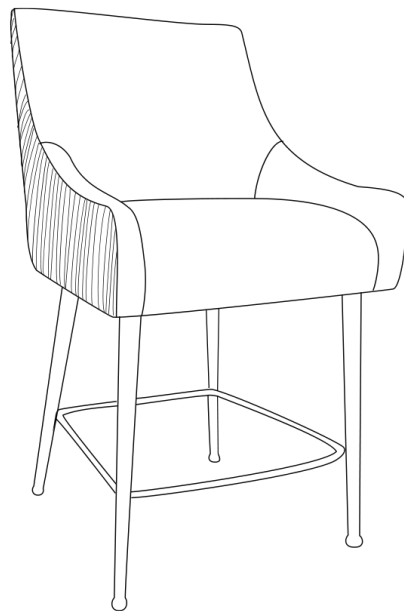



Beatrix Pleated Barstool/Counterstool

# BEATRIX



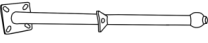

## ASSEMBLY INSTRUCTIONS



## PARTS LIST

LABEL	PICTURE	DESCRIPTION	QTY
<b>A</b>		<b>Chair Body</b>	<b>1</b>
<b>B</b>		<b>Front Leg</b>	2
<b>C</b>		<b>Back Leg</b>	2
<b>D</b>		<b>Foot rest</b>	1

## HARDWARE

LABEL	PICTURE	DESCRIPTION	QTY
<b>E</b>		<b>Metal Gasket</b>	24
<b>F</b>		<b>Spring Washer</b>	16
<b>G</b>		<b>Screw(M6*30)</b>	16
<b>H</b>		<b>Screw(M6*16)</b>	<b>4</b>
<b>I</b>		<b>Wrench</b>	<b>1</b>

### BEFORE BEGINNING ASSEMBLY:



*Read instructions cover to cover*



*Have two adults on hand for assembly*



*Do NOT assemble on flooring or carpet. Assemble on a clean non-marring surface (ex: packing foam)*



*Save all packaging until assembly is completed*

*Need a part? Call TOV at 516-888-3355 or email [service@tovfurniture.com](mailto:service@tovfurniture.com)*

---

## ASSEMBLY STEPS

---

### STEP 1

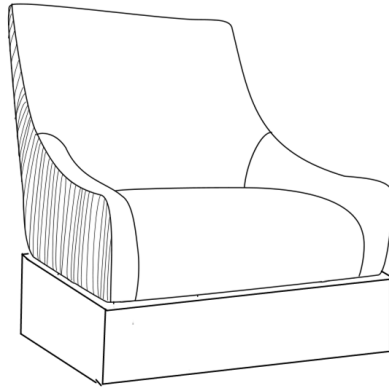

Open the carton to remove the chair body, parts and hardware package.

---

### STEP 2

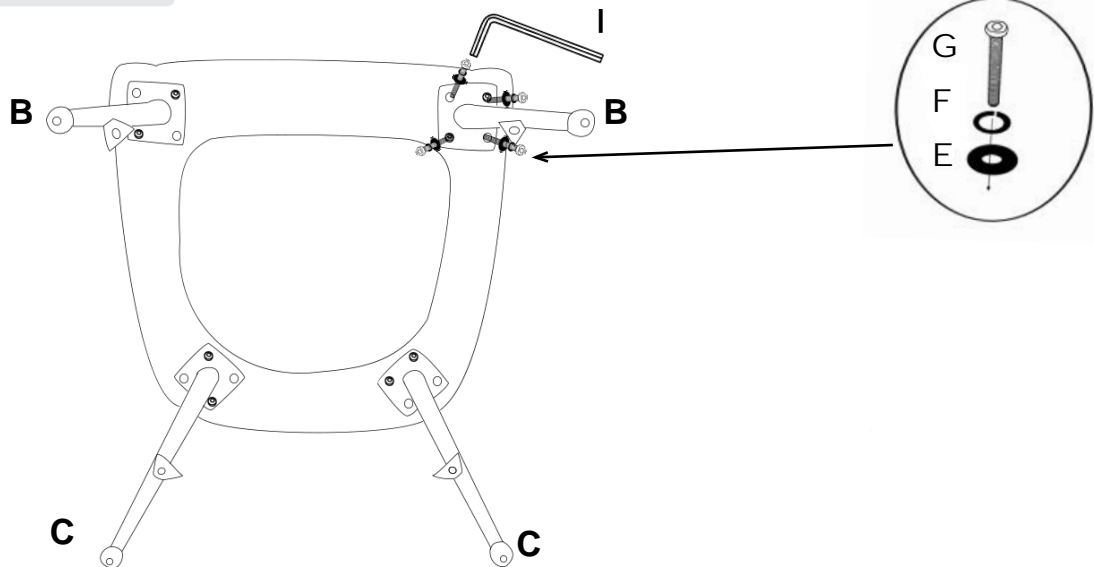

Use provided hardware to attach Leg B and C.  
Do not fully tighten them until the last step.

### STEP 3

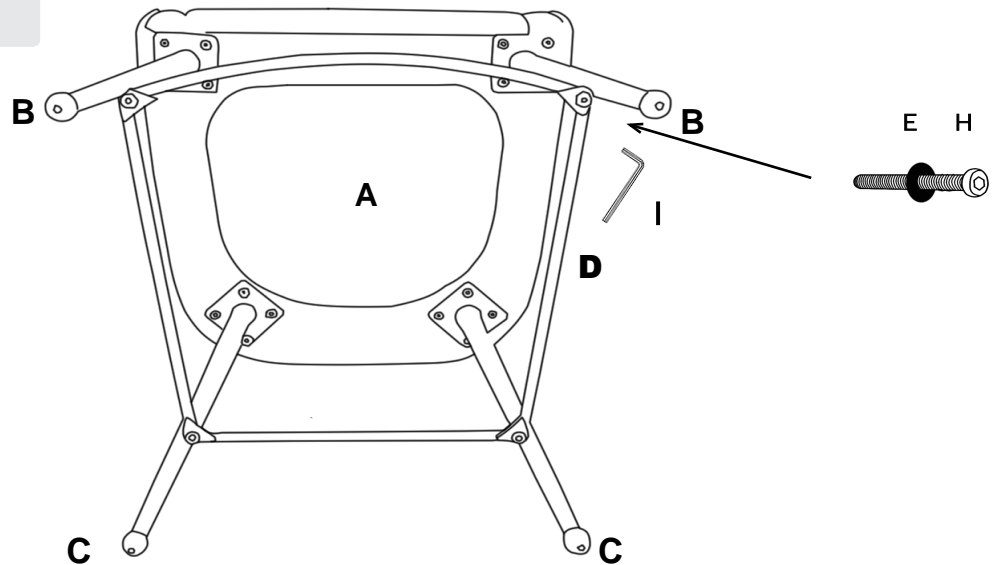

Insert the 4 pcs of Screws (H) into the holes to connect the foot rest. Use Wrench (I) to tighten the Screws (H) clockwise, do not fully tighten until the last step.

### STEP 4

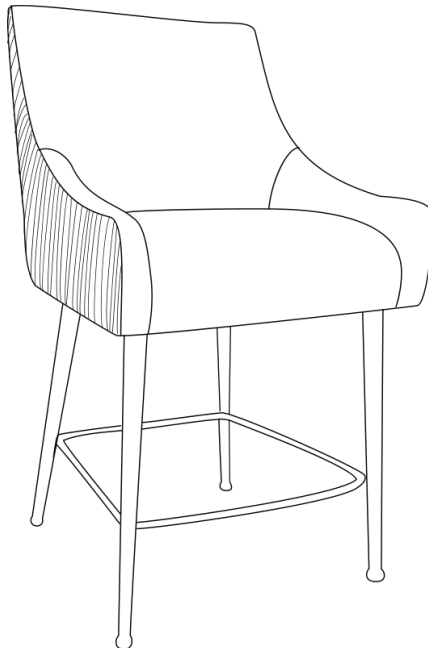

Turn over the barstool/Counterstool and adjust the angle of the legs until they are even.

Fully tighten the Screws(H).

Fully tighten Screws(G) at last.

Assembly is completed.

## CARE & MAINTENANCE



**Do not put hot items directly on furniture surface.**



**Do not clean furniture with harsh cleansers or polish.**



**Dust and pick up spills using a clean, non-colored, lint-free cloth.**



**Stains may be removed with a mild soap solution and a damp cloth.**



**Do not place furniture under direct sunlight.**



**Do not place furniture near heating or cooling vents.**



**Do not write on furniture without a padded barrier to protect the surface.**



**Do not place furniture outside, for indoor use only.**