

Elika Oval Dining Table

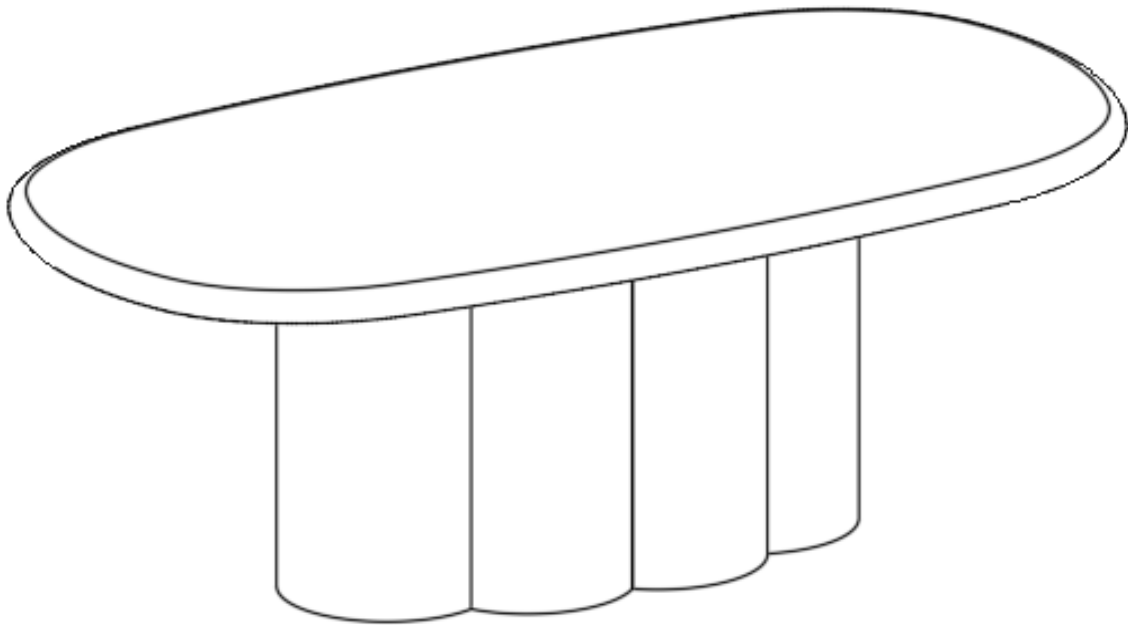

ELIKA



ASSEMBLY INSTRUCTIONS

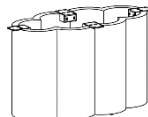

PARTS LIST

LABEL	PICTURE	DESCRIPTION	QTY
A		TOP	1
B		BASE	1

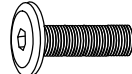
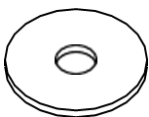
PARTS LIST

LABEL	PICTURE	DESCRIPTION	QTY
C		BOLT M8x25	8
D		WASHER Ø22x2	8
E		ALLEN KEY	1

BEFORE BEGINNING ASSEMBLY:



Read instructions cover to cover



Have two adults on hand for assembly



Do NOT assemble on flooring or carpet. Assemble on a clean non-marring surface (ex: packing foam)



Save all packaging until assembly is completed

ASSEMBLY STEPS

STEP#1

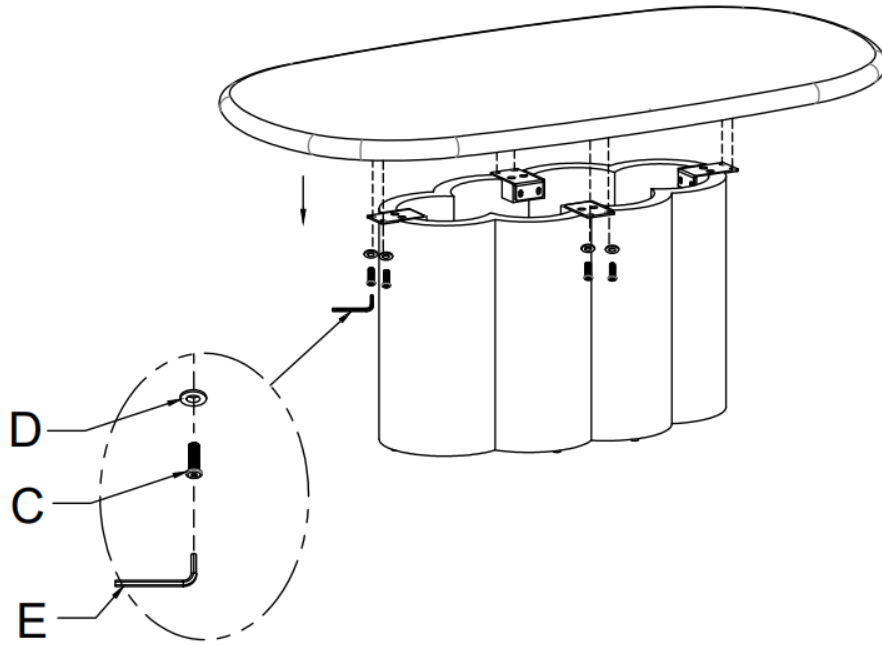

STEP#2

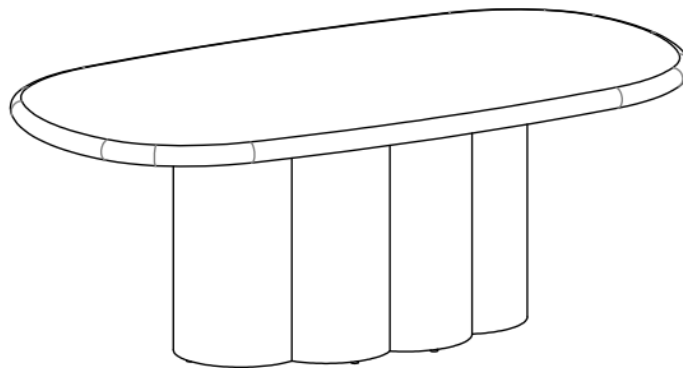

CARE & MAINTENANCE



Do not put hot items directly on furniture surface.



Do not clean furniture with harsh cleansers or polish



Dust and wipe up spills using a clean, non-colored, lint-free cloth.



Stains may be removed with a mild soap solution and a damp cloth.



Do not place furniture under direct sunlight.



Do not place furniture near heating or cooling vents.



Do not write on furniture without a padded barrier to protect the surface.



Safe for outdoor, recommend under roof.

"Need a part? Call TOV at 516-888-3355 or
[email service@tovfurniture.com](mailto:email.service@tovfurniture.com)"