

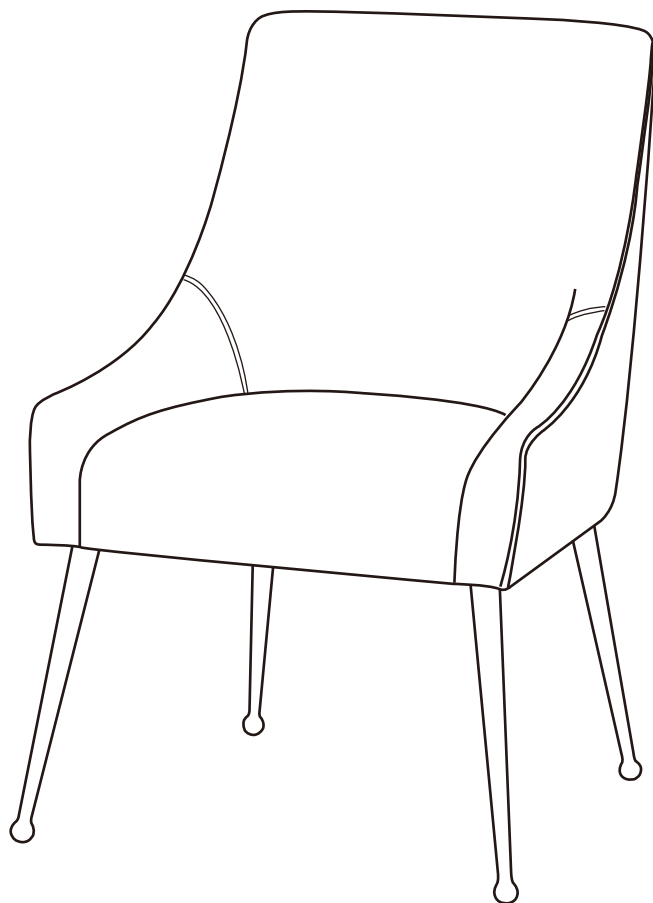

BEATRIX VELVET SIDE CHAIR

BEATRIX



Assembly Instructions



PARTS LIST

LABEL	PICTURE	DESCRIPTION	QTY
A		Chair	1
B		Legs	4

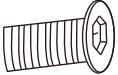
HARDWARE

LABEL	PICTURE	DESCRIPTION	QTY
a		Metal Gasket	12
b		Screw M6X30	12
c		Wrench	1
d		Spring Washer	12

BEFORE BEGINNING ASSEMBLY:



Read instructions cover to cover



Have two adults on hand for assembly



Do NOT assemble on flooring or carpet. Assemble on a clean non-marring surface (ex: packing foam)



Save all packaging until assembly is completed

Need a part? Call TOV at 516-888-3355 or email service@tovfurniture.com

ASSEMBLY STEPS

STEP 1

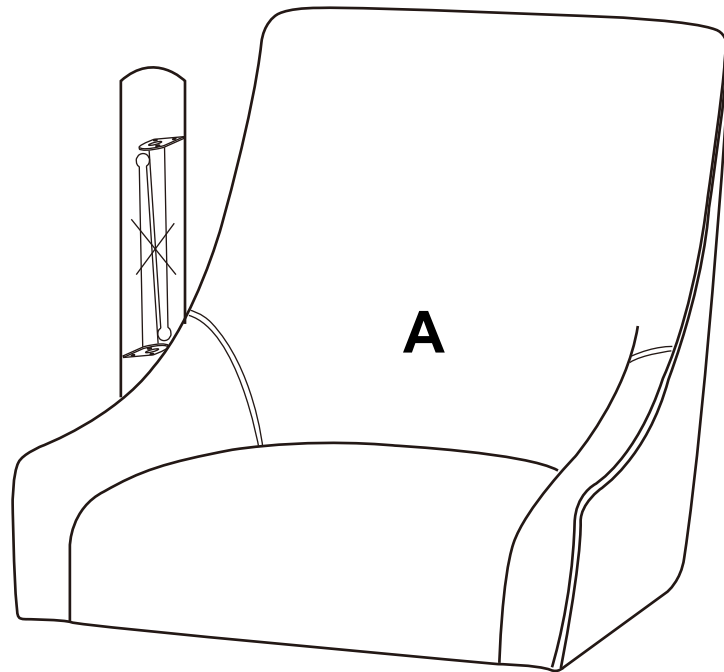

- > Legs and hardware are packaged together.
- > Open the Legs & HW box to remove the legs and HW.

STEP 2

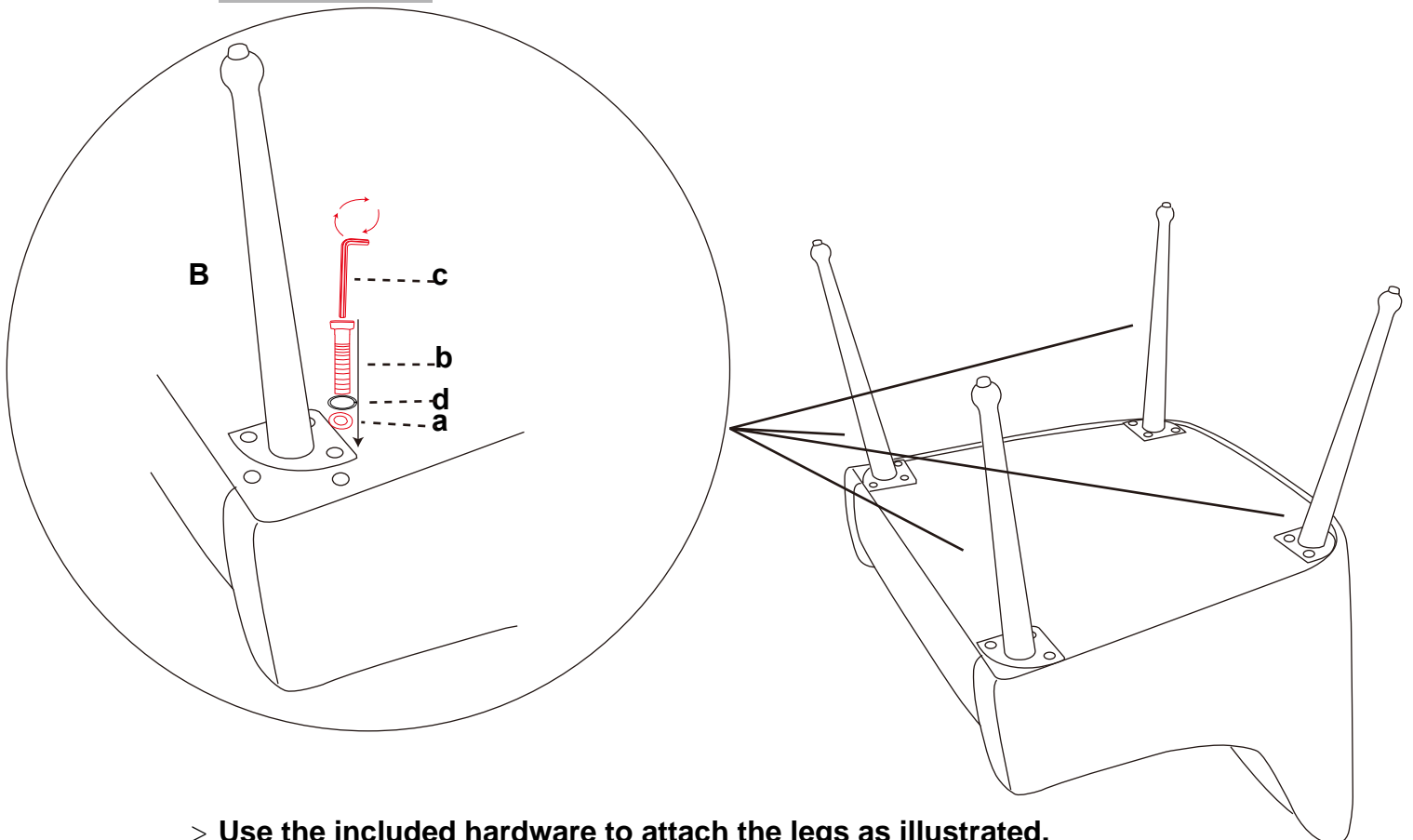

- > Use the included hardware to attach the legs as illustrated.

CARE & MAINTENANCE



Do not put hot items directly on furniture surface.



Do not clean furniture with harsh cleansers or polish.



Dust and wipe up spills using a clean, non-colored, lint-free cloth.



Stains may be removed with mild soap solution and a damp cloth.



Do not place furniture under direct sunlight.



Do not place furniture near heating or cooling vents.



Do not write on furniture without a padded barrier to protect the surface.



Do not place furniture outside, for indoor use only.