

SIERRA BED

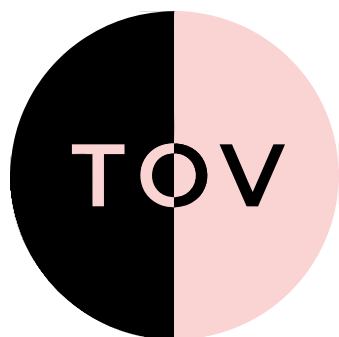

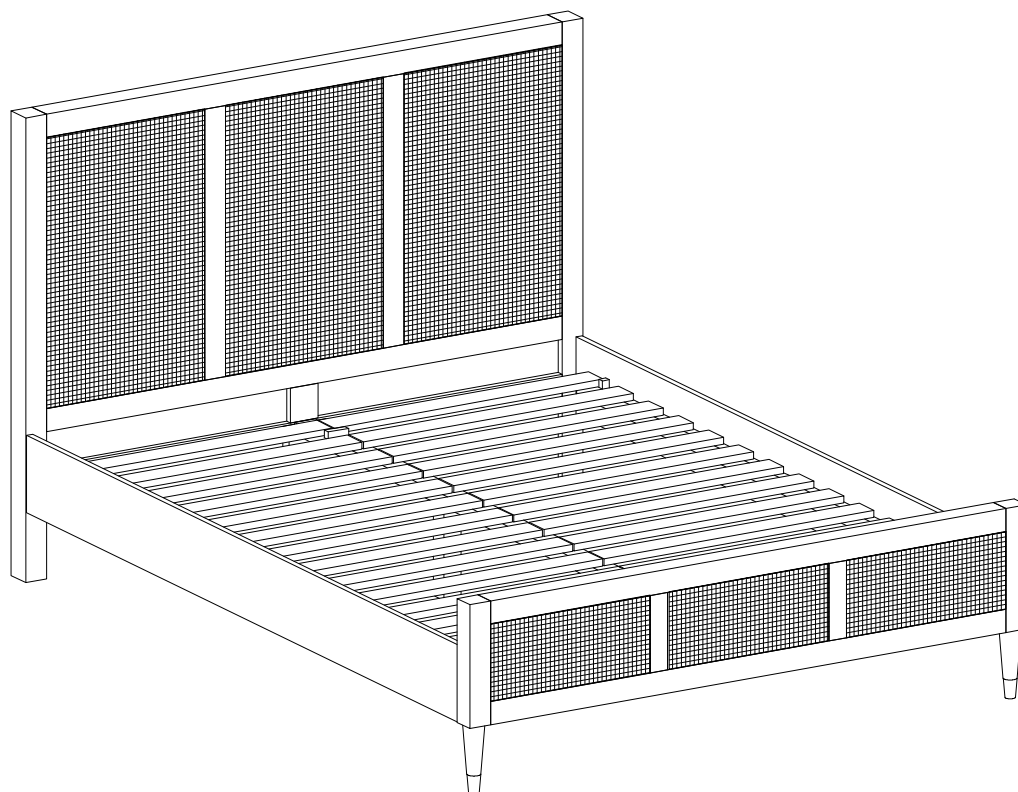





SIERRA



ASSEMBLY INSTRUCTIONS







PARTS LIST

LABEL	PICTURE	DESCRIPTION	QTY
A		HEADBOARD	1
B		FOOTBOARD	1
C		SIDERAIL LEFT AND RIGHT	2
D		MIDDLE RAIL	1
E		CENTER LEGS	2
F		SLAT FRAME (14 wood bar)	2

HARDWARE

LABEL	PICTURE	DESCRIPTION	QTY
G		SCREW M6x10	8
H		WRENCH M5x60	1
L		SCREW M4x30	14

BEFORE BEGINNING ASSEMBLY:

-  Read instructions cover to cover
-  Have two adults on hand for assembly
-  Do NOT assemble on flooring or carpet. Assemble on a clean non-marring surface (ex: packing foam)
-  Save all packaging until assembly is completed

ASSEMBLY STEPS

STEP 1

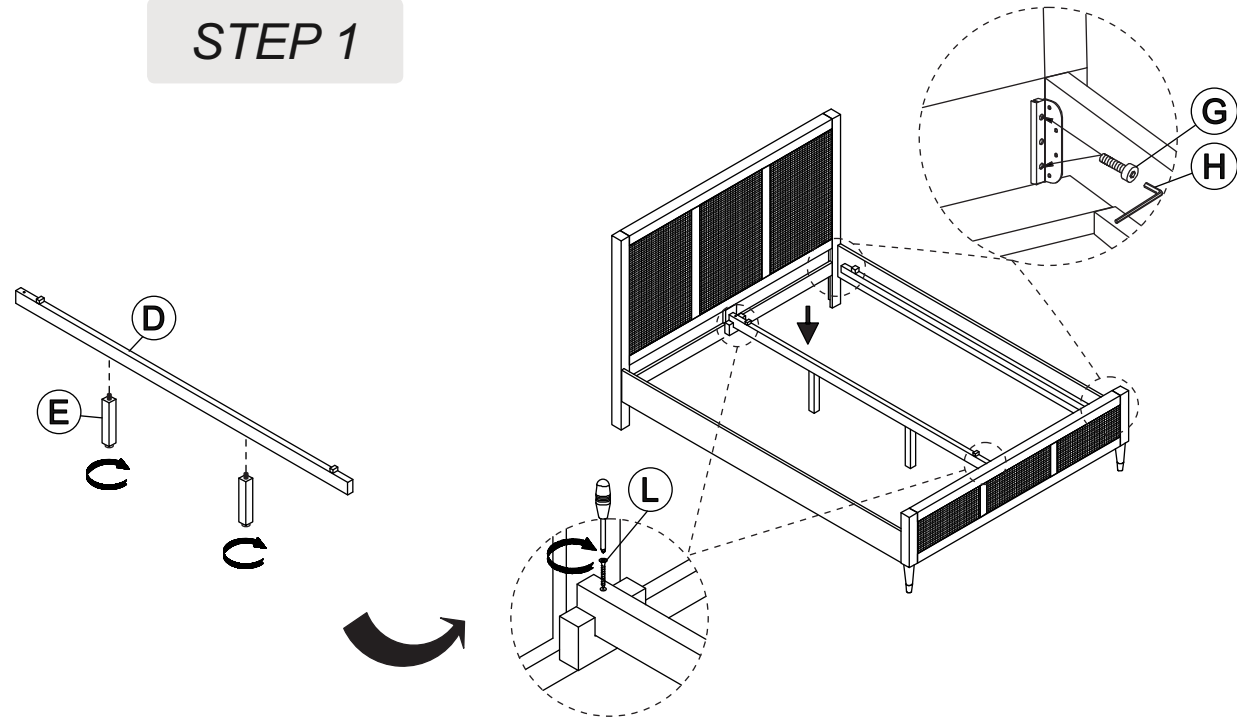

STEP 2

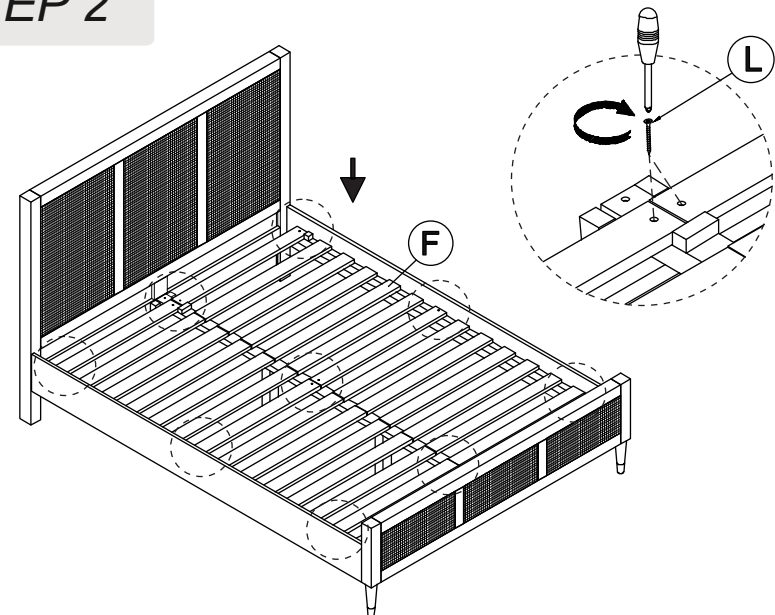

CARE & MAINTENANCE



Do not put hot items directly on furniture surface.



Do not clean furniture with harsh cleansers or polish



Dust and wipe up spills using a clean, non-colored, lint-free cloth.



Stains may be removed with a mild soap solution and a damp cloth.



Do not place furniture under direct sunlight.



Do not place furniture near heating or cooling vents.



Do not write on furniture without a padded barrier to protect the surface.



Do not place furniture outside, for indoor use only.

**"Need a part? Call TOV at 516-888-3355 or
email service@tovfurniture.com"**