

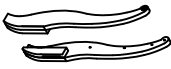







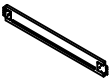

Assembly instructions for QUEEN BED 579-140 /141/143 H/F/R

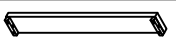
Caution: please read instructions thoroughly before unpacking assembly parts. Sharp, exposed staple tips can cause injury, therefore, for your protection, please remove any exposed staples used in packing

1. We recommend that you should assemble this product with the assistance of another persons , this will make assembly easier, and will help to eliminate damage to the product or injury to persons during assembly.
2. Be sure to check all packing materials carefully for small parts that may have come loose inside the carton during shipment.
3. Please do not over tighten screws or bolts.
4. Please put all parts on a non-abrasive floor before assembly, and follow the assembly steps to assemble your newly purchased product correctly and efficiently.

PART LIST			
No.	Description		Q'ty
1	Headboard Panel		1
2	Left/Right Posts		2
3	Sleigh Footboard		1
4	Side rail		2
5	Slat		3
6	Slat support leg		6
7	Stretcher of headboard		1

ASSEMBLY HARDWARE LIST (packed with Headboard) (579-140/144)				
No.		Description		Quantity
A		Allen Key	5mm	1 piece
B		Bolt	Ø5/16"*18*1-1/2"L	10 pieces
C		Lock washer	Ø5/16"*13mm*2mmT	10 pieces
D		Flat washer	Ø5/16"*19mm*2mmT	10 pieces

ASSEMBLY HARDWARE LIST (packed with Queen Footboard) (579-141)				
E		Description		Quantity
E		Screw for slats	#8*1" L	6 pieces

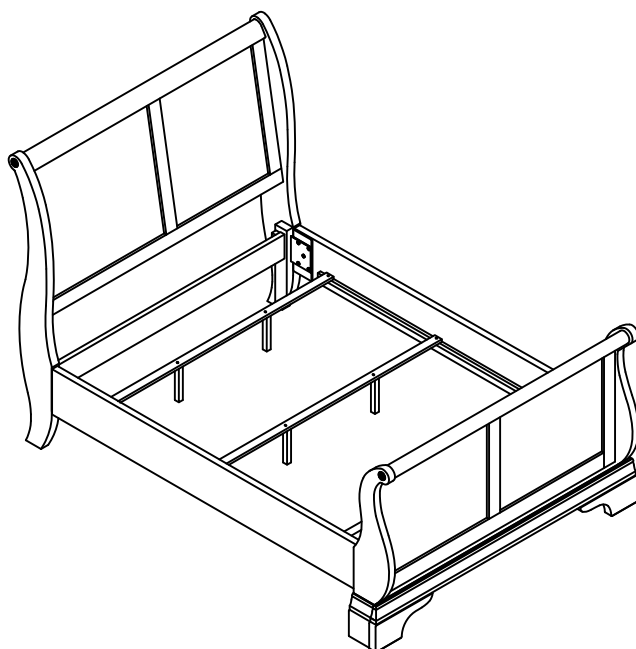

Assembly instructions for QUEEN BED 579-140 /141/143 H/F/R

