



Item# : CY400SK

Description : CAYLA SIDE CHAIR DARK OAK

Product Size : 20" x 24" x 40" H

Your furniture purchase is an investment. Here are a few tips to maximize the lifetime of your furniture with a minimum amount of effort. Properly caring for your furniture can help ensure that it looks great year after year.

Wood Furniture Maintenance:

- Always dust, wipe, and clean *with* the grain of the wood.
- Dust with a soft cloth. Dust will scratch the furniture surface if not removed properly.
- Use the same type of polish consistently as interchanging oil-based and wax-based polishes will cause a build-up and result in a foggy or cloudy appearance.
- If a polished surface becomes foggy, rub it with a cloth dipped in a solution of one tablespoon vinegar to one quart of water. Rub softly with the grain until the surface is completely dry.
- Soap and water are not advisable for wood surfaces. Water can penetrate the finish and raise the grain on wood, causing damage.
- Remember to change dusting cloths frequently as dirty cloths may scratch your furniture's surface.

The Enemies of Wood:

- Moisture is wood's worst enemy. Liquid spills should be gently wiped up immediately. Coasters should be used under all beverages.
- Do not allow rubber or vinyl materials to lie on the furniture. Chemicals in rubber may leave a stain. Put a strip of felt or leather under accessories that have rubber or vinyl.
- Heat creates a chemical change in the furniture's finish, which results in a white spot. Use protective pads under hot dishes, appliances, etc.
- Sunlight's ultraviolet rays can damage the finish of furniture. Do not place furniture directly against a heater or radiator and do not place in the path of hot streams of air from central heating. This will cause extreme localized drying of the wood.

High Gloss Resin Table Maintenance:

- Resin tabletops have approximately 1/8" of a resin coat on the top face of the table, which will resist ice, water, wine, liquor, food, cleaning fluids, and warm or hot liquids; however, cups, glasses, etc. containing hot liquids should not be left on the table without a coaster for protection.
- Resin tabletops will scratch just the same as any other glossy surface and basic precautions should be taken.
- For lasting shine, the resin table should be waxed with a car wax that does not contain silicon. Maintaining this wax build-up will result in a high gloss shine.
- When wiping down the table, a soft, clean rag should be used. Do not use a heavy paper.

Granite Top Maintenance:

The surface of the granite on your table has been polished or sealed to create a generally non-porous surface. The stone has many natural characteristics including: veining, hairline cracks, and color variations - which make up the stone's beauty.

To maintain the beauty of your granite:

- Protect surfaces from scratching, staining and etching by:
 - * Keeping them free of debris or sharp objects
 - * Wiping up spills immediately
 - * Avoiding contact with chemicals (particularly acid-based materials)
- Clean with pH neutral products or those especially formulated for use on stone.
- It is not recommended to use a water-based solvent for dark granite as it will remove the polish from the surface. absorbed into the stone.
- After a period of use, apply a penetrating sealer to prevent contaminants from being
- Remove stains with special absorbent poultices formulated for use on stone.
- Renew the surface on polished granite (granite with a high gloss surface) by buffing with special stone polish , powder or cream .
 - Do not use granite polish on granite with a matte finish, which has been honed rather than polished. (Penetrating sealer may be used on both polished and honed granite.)

Marble Top Maintenance:

Marble may be stone, but it is porous stone and can stain easily. Treating marble surfaces the same as wood surfaces is a great rule of thumb.

- It is recommended to seal the tops on a regular basis (every 6 to 12 months). A good quality stone sealer can be purchased from any tiles/stone store or any homeware store and should be applied according to the manufacturer's recommendation.
- When sealed properly, marble tops can be used indoors and outdoors and can withstand any weather conditions except internal freezing. Snow or freezing rain will penetrate the table and cause cracks.

Caring for the Fabric on Upholstered Furniture:

- Frequent vacuuming of the entire upholstered area will prevent dust from settling into the fibers.
- Professional cleaning is always recommended for all upholstered pieces.
- Always pre-test a small area of fabric in an inconspicuous area when cleaning before proceeding.
- Do not use cleaning products containing brightening agents.

VERY IMPORTANT!!

NEVER
USE GLASS CLEANERS
ON FINISHED SURFACES.
AMMONIA WILL
CHEMICALLY ATTACK
THE FINISH.

DO NOT
WRITE
DIRECTLY
ON
SURFACE 

**PREVENT
MARKING**

DO NOT
PLACE
DIRECTLY
IN
SUNLIGHT 

**PREVENT
FADING**

DO NOT
USE
PLACEMATS
WITH
RUBBER
BASES 

**PREVENT
DISCOLORING**

NEVER
ALLOW LIQUIDS OF ANY
KIND TO LINGER ON
SURFACES. ABSORPTION
CAUSES THE WOOD TO
WARP AND THE FINISH
TO DE-LAMINATE.

DO NOT USE
COMMERCIAL
POLISHES
AND WAXES 

**PREVENT
YELLOWING**

DO NOT
PLACE HOT
POTS, ETC.
ON
SURFACE 

**PREVENT
DAMAGE TO
FINISH!**

REGULATE
THE
HUMIDITY
CONDITIONS
AT YOUR
HOME 

**PREVENT
SPLITTING**

ASSEMBLY INSTRUCTIONS

Do not fully tighten bolts and screws until the entire item is completely assembled.



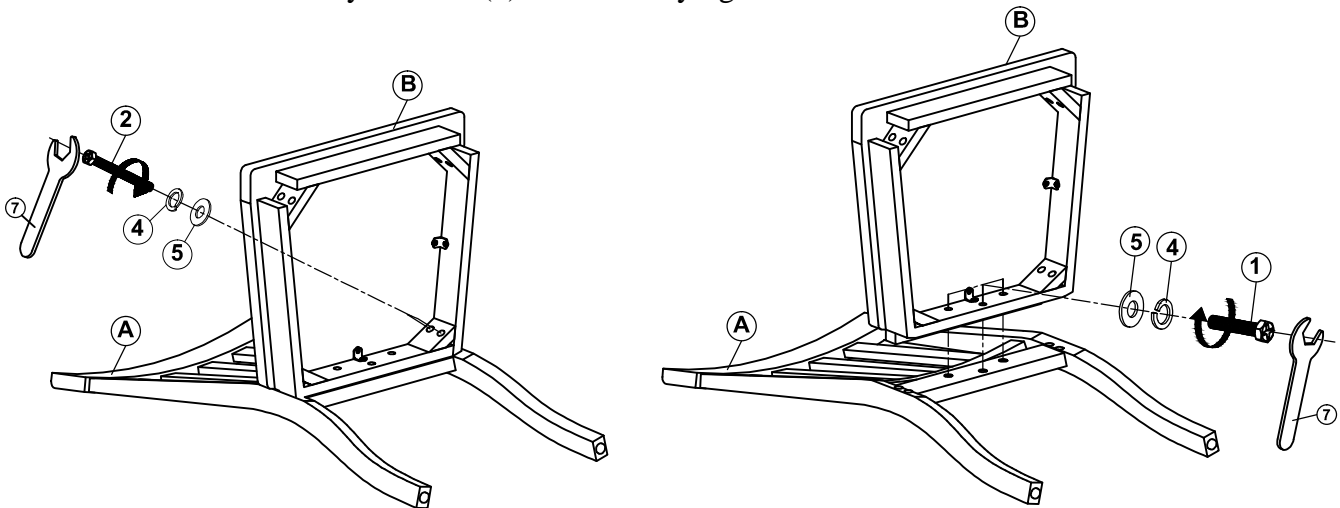

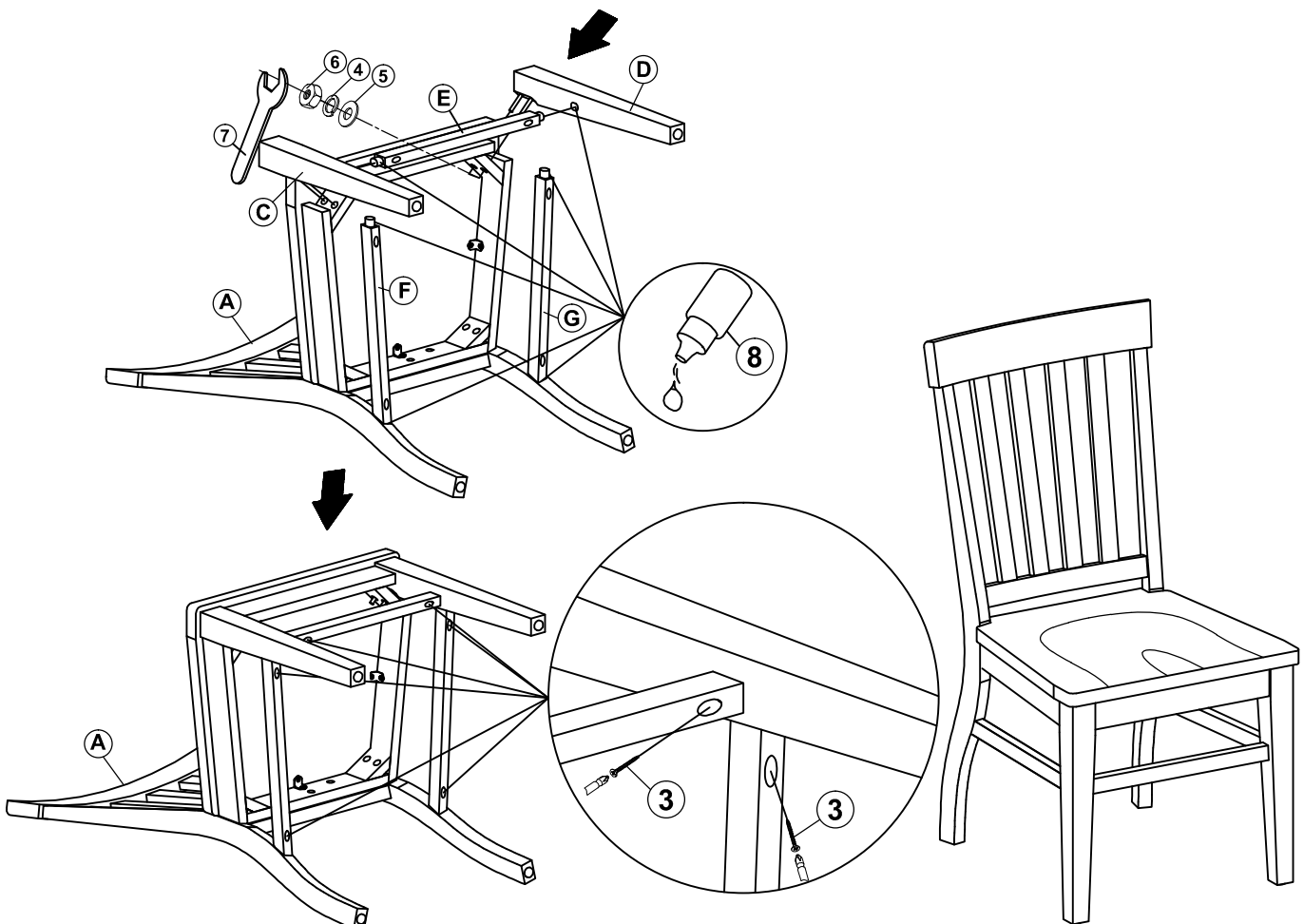

STEP 1 : Place the Chair Back (A) on the floor. Attach Wood Seat w/ Seat Box (B) to the Chair Back (A) by using Flat Washer (5), Lock Washer (4), and Long Bolt (2) into the holes at the corner block of the seat frame. Secure by Wrench. Insert Flat Washer (5), Lock Washer (4), and Short Bolt (1) into the rear bar of seat frame. Secure by Wrench (7). Do not fully tighten.





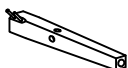
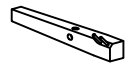





STEP 2: Attach the LSF/RSF Front Leg (C,D) to Wood Seat w/Seat Box (B) by using Flat Washer (5), Lock Washer (4), Hex Nut (6) and secure by Wrench (7). Attach Front Stretcher (E) and LSF/RSF Stretcher (F,G) to the LSF/RSF Front Leg (C, D) and Chair Back (A) by using Screws (3), tighten by a Phillips-head screw driver (Tool required). Insert Wood Glue (8) into the holes as picture shown. Fully tighten all bolts and screws as this time. Assembly product is now completed.



PARTS LIST

No.	Parts List		Q' ty
A		Chair Back	1
B		Wood Seat w/ Seat Box	1
C		LSF Front Leg	1
D		RSF Front Leg	1
E		Front Stretcher	1
F		LSF Stretcher	1
G		RSF Stretcher	1

HARDWARE LIST

No.	Description	Dimension	Q'ty
1	 Short Bolt	Ø 5/16* 40mm	3
2	 Long Bolt	Ø 5/16* 76mm	4
3	 Screw	Ø 8* 45mm	6
4	 Lock Washer	Ø 5/16 * 8mm	11
5	 Flat Washer	Ø 5/16 * 19mm	11
6	 Hex Nut	Ø 5/16"*12 mm	4
7	 Wrench	12mm	1
8	 Wood Glue		1

PARTS FOR CY400SK

COMPLETE HARDWARE #: PCY400SK

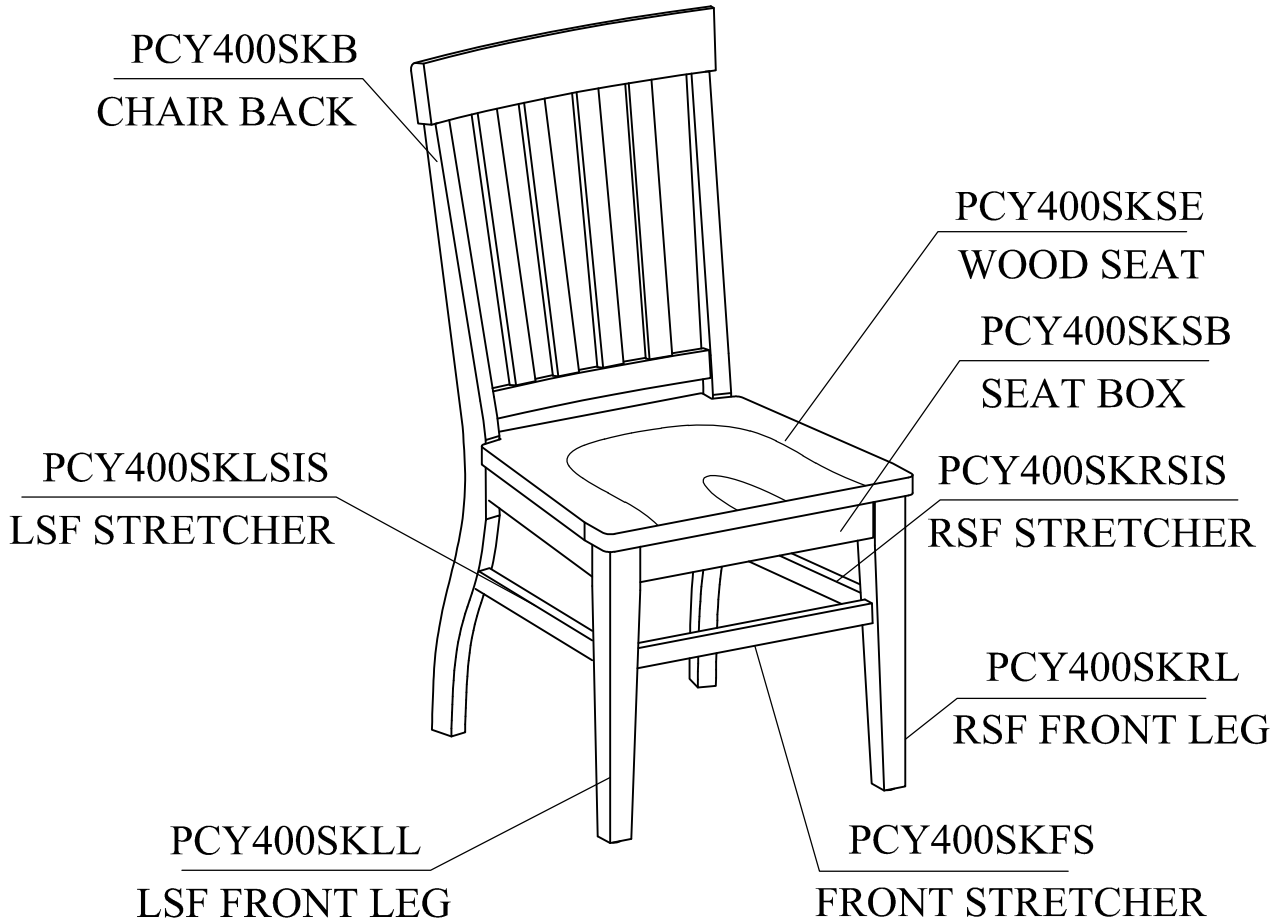

PRODUCT DETAILS

CHAIR BACK	RUBBER WOOD
SEAT BOX	RUBBER WOOD
WOOD SEAT	RUBBER WOOD
FRONT LEG	RUBBER WOOD
STRETCHER	RUBBER WOOD
PRODUCT SIZE	20" x 24" x 40" H
CARTON SIZE	41.75" x 21.5" x 13.25"H
NET WEIGHT	48.4LBS
GROSS WEIGHT	59.4LBS
CU.FT.	6.88 / 2 PCS

MADE IN VIETNAM