



Item # : AL4848SG

Description: AMALIE SIDE CHAIR GRAY

Product Size : 19.25" x 23.5" x 36"H

Your furniture purchase is an investment. Furniture can last life times, with a minimum amount of effort. Here are a few tips to properly care for your furniture, ensuring that it looks great year after year.

Wood Furniture Maintenance:

- Always dust, wipe, and clean with the grain of the wood.
- Dust with a soft cloth. Dust will scratch the furniture surface if not removed properly.
- Use the same type of polish consistently as interchanging oil-based and wax-based polishes will cause a build-up and result in a foggy or cloudy appearance.
- If a polished surface become foggy, rub it with a cloth dipped in a solution of one tablespoon vinegar to one quart of water .
- Rub softly with the grain until the surface is completely dry.
- Soap and water are not advisable for wood surfaces. Water can penetrate the finish and raise the grain on wood, causing damage.
- Remember to change dusting cloths frequently as dirty cloths may scratch your furniture's surface .
- The Enemies of Wood:
 - Moisture is wood's worst enemy. Liquid spills should be gently wiped up immediately. Coasters should be used under all beverages.
 - Do not allow rubber or vinyl materials to lie on the furniture. Chemicals in rubber may leave a stain. Put a strip of felt or leather under accessories that have rubber or vinyl.
 - Heat creates a chemical change in the furniture's finish, which results in a white spot. Use protective pads under hot dishes, appliances, etc.
 - Sunlight's ultraviolet rays can damage the finish of furniture. Do not place furniture directly against heater or radiator and do not place in the path of hot streams of air from central heating. This will cause extreme localized drying of the wood.

High Gloss Resin Table Maintenance:

- Resin tabletops have approximately 1/8" of a resin coat on the top face of the table, which will resist ice, water, wine, liquor, food, cleaning fluids, and warm or hot liquids; however, cups, glasses, etc, containing hot liquids should not be left on the table without a coaster for protection.
- Resin tabletops will scratch just the same as any other glossy surface and basic precautions should be taken.
- For lasting shine, the resin should be waxed with a car wax the does not contain silicon. Maintaining this wax build-up will result in a high gloss shine.
- When wiping down the table, a soft, clean rag should be used. Do not use a heavy paper.

Granite Top Maintenance:

- The surface of granite on your table has been polished or sealed to create a generally non-porous surface. The stone has many natural characteristics including: veining, hairline cracks, and color variations- which make up the stone's beauty.
- To maintain the beauty of your granite:
- Protect surfaces from scratching, staining and etching by
 - *Keeping them free of debris or sharp objects.
 - *Wiping up spills immediately.
 - *Avoiding contact with chemicals (particularly acid -based materials)
 - Clean with pH neutral products or those especially formulated for use on stone.
 - It is not recommended to use a water - based solvent for dark granite as it remove the polish from the surface.
 - After a period of use, apply a penetrating sealer to prevent contaminants from being absorbed into the stone.
 - Remove stains with special absorbent poultices formulated for use on stone.
 - Renew the surface on polished granite (granite with a high gloss surface) by buffing with special stone polish, powder or cream.
 - Do not use granite polish on granite with a matte finish, which has been honed rather than polished. (Penetrating sealer may be used on both polished and honed granite).







Marble Top Maintenance :

- Marble may be stone, but it is porous stone and can stain easily. Treating marble surfaces the same as wood surfaces is a great rule of thumb.
- It is recommended to seal the tops on a regular basis (every 6 to 12 months) A good quality stone sealer can be purchased from any tiles/stone store or any homecare store and should be applied according to the manufacture's recommendation.
 - When sealed properly, marble tops can be used indoors and outdoors and can withstand any weather conditions except internal freezing. Snow or freezing rain will penetrate the table and cause cracks.

Caring for the Fabric on Upholstered Furniture:

- Frequent vacuuming of the entire upholstered area will prevent dust from settling in to the fibers.
- Professional cleaning is always recommended for all upholstered pieces.
- Always pre -test a small area of fabric in a inconspicuous area when cleaning before proceeding.
- Do not use cleaning products containing brightening agents.

VERY IMPORTANT !!

<p>NEVER USE GLASS CLEANERS ON FINISHED SURFACE AMMONIA WILL CHEMICALLY ATTACK THE FINISH.</p>	<p>DO NOT WRITE DIRECTLY ON SURFACE  PREVENT MARKING</p>	<p>DO NOT PLACE DIRECTLY IN SUNLIGHT  PREVENT FADING</p>	<p>DO NOT WRITE PLACEMATS WITH RUBBER BASES  PREVENT DISCOLORING</p>
<p>NEVER ALLOW LIQUIDS OF ANY KIND TO LINGER ON SURFACE ABSORPTION CAUSES THE WOOD TO WARP AND THE FINISH TO DE LAMINATE.</p>	<p>DO NOT USE COMMERCIAL POLISHES AND WAXES  PREVENT YELLOWING</p>	<p>DO NOT PLACE HOT POTS, ETC ON SURFACE  PREVENT DAMAGE TO FINISH</p>	<p>DO NOT USE COMMERCIAL POLISHES AND WAXES  PREVENT SPLITTING</p>

AL4848SG

ASSEMBLY INSTRUCTIONS

DO NOT FULLY TIGHTEN BOLTS AND SCREWS UNTIL THE ENTIRE ITEM IS COMPLETELY ASSEMBLED

STEP 1: Turn the Chair Back (A) on the floor with a piece of cloth or carpet underneath to prevent finish from scratching. Attach Seat Box w/ Seat Cushion (B) to the Chair Back (A) by using Long Bolt (3), Flat Washer (2), Spring Washer(1) into the holes at the corner block of the Seat Box w/Seat Cushion (B), insert Short Bolt (4), Flat Washer (2), Spring Washer (1) into the rear bar of the seat frame. Tighten by Wrench (6). Do not fully tighten.

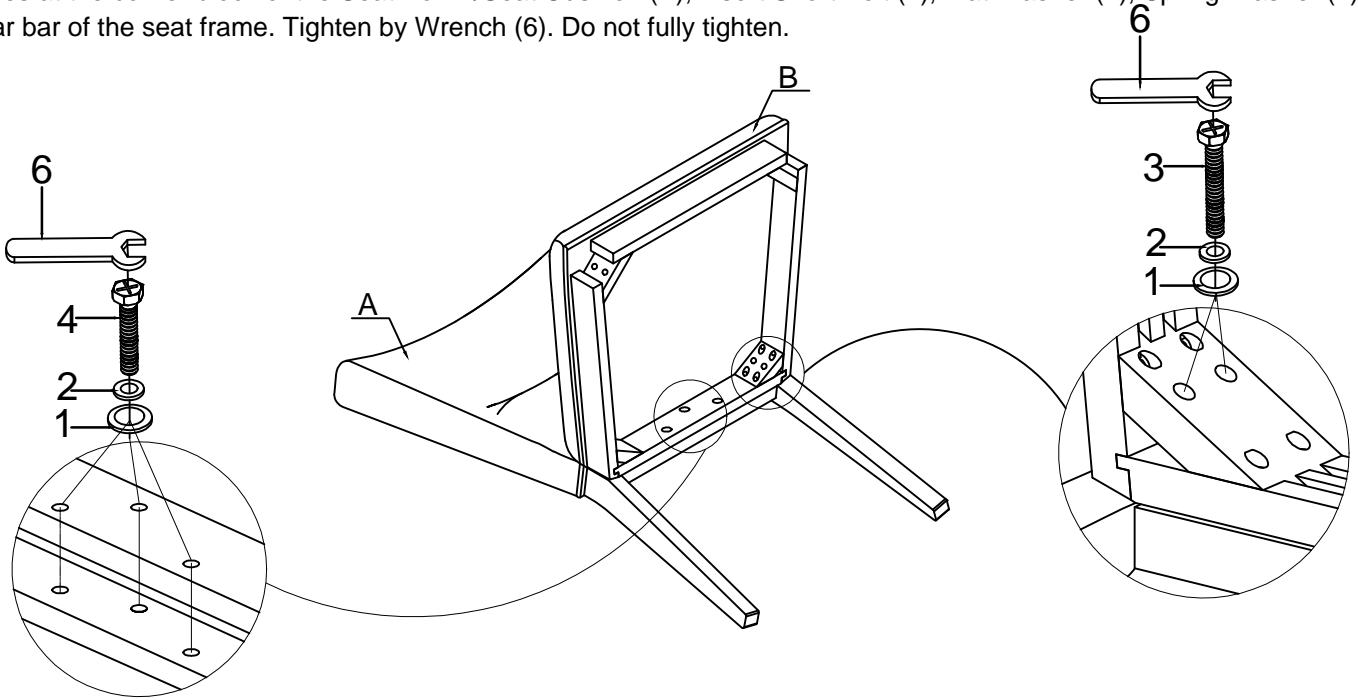

STEP 2: Attach Front Leg (C) to the Seat Box W/ Cushion Seat (B) by using Spring Washer (1), Flat Washer (2), Hex Nut (5) and secure by Wrench (6). Fully tighten all bolts at this time, turn over the chair. Assembly product is now completed.

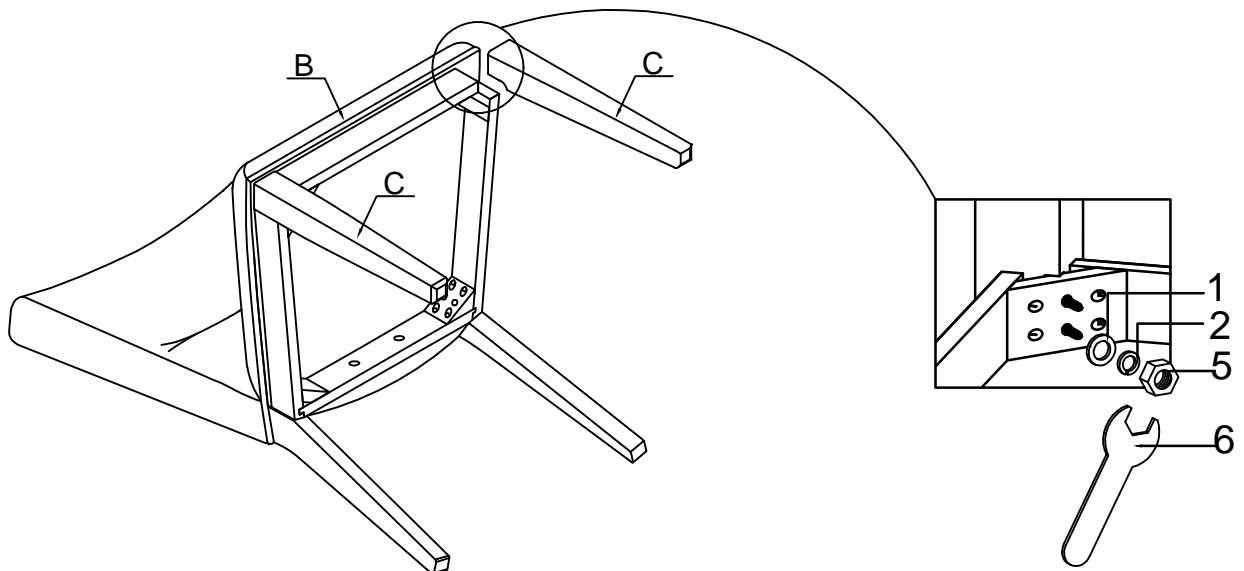

PARTS LIST

P3/5

(A) CHAIR BACK (1PC)

(B) SEAT BOX
w/ SEAT CUSHION (1PC)

(C) FRONT LEG (2PCS)

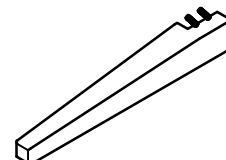
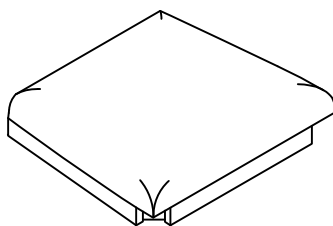
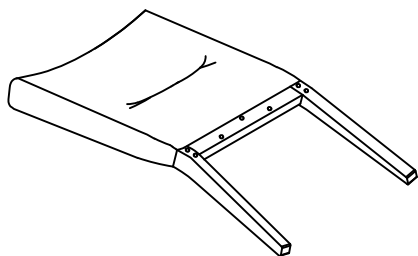

HARDWARE PACK #: PAL4848SGH

No

Description

Q'TY

1



Spring Washer

Ø13x2mm

11 pcs

2



Flat Washer

Ø19x2mm

11 pcs

3



Long Bolt

Ø5/16"x80mm

4 pcs

4



Short Bolt

Ø5/16"x40mm

3 pcs

5



Hex Nut

Ø5/16"x12x6mm

4 pcs

6

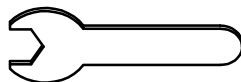

Wrench

Ø5/16"x90mm

1 pc

PARTS FOR AL4848SG

COMPLETE HARDWARE #: PAL4848SGH

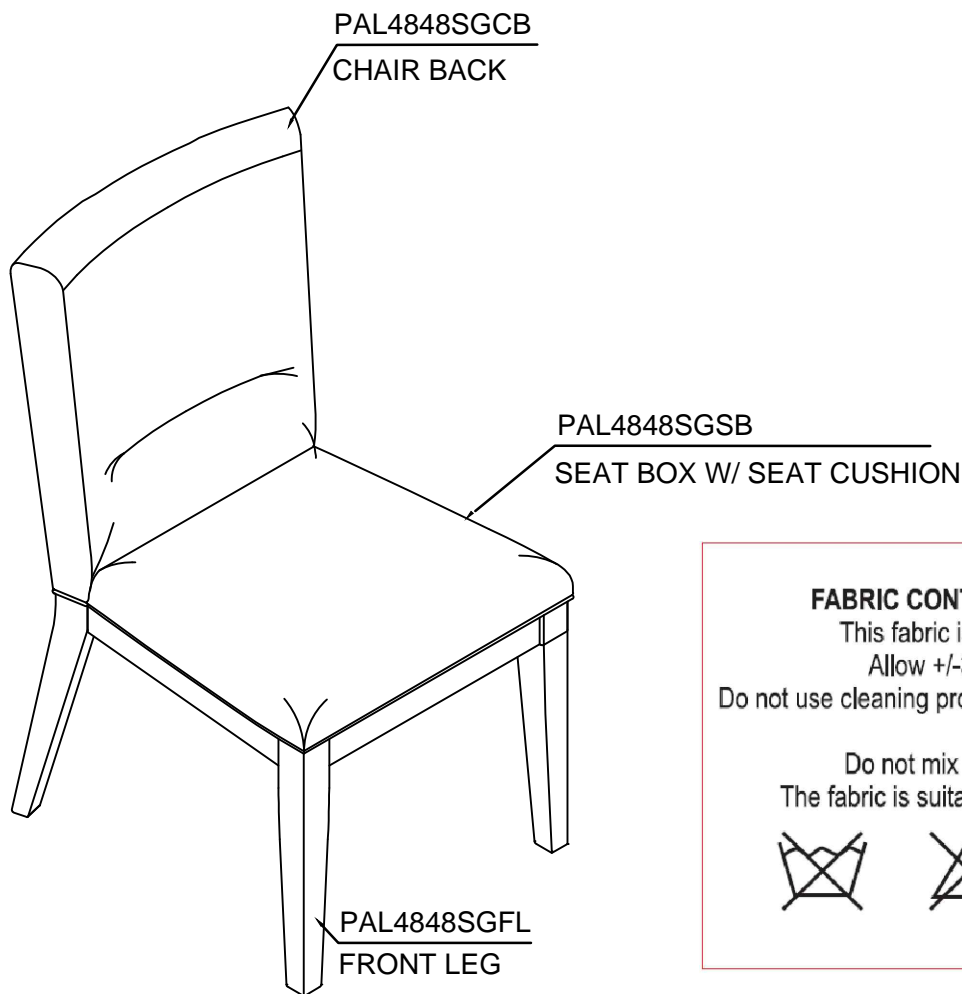

FABRIC CONTENT : POLYESTER 100%
 This fabric is not machine washable.
 Allow +/-3% residual shrinkage
 Do not use cleaning products containing brightening agents

Do not mix fabric of different colors.
 The fabric is suitable for drapery and upholstery





PRODUCT DETAILS	
BACK	RUBBER WOOD
SEAT BOX	RUBBER WOOD
LEG	RUBBER WOOD
PRODUCT SIZE	19.25"x 23.5"x 36" H
CARTON SIZE	38.75"x12"x19.5" H
CUFT/CTN	5.25' / 2PCS
NET WEIGHT	30.8 LBS / 2PCS
GROSS WEIGHT	37.4 LBS / 2PCS

MADE IN VIET NAM

Steve Silver Company Dining Chairs

- Assembly Troubleshooting Guide

The most important element of correct chair assembly is to tighten the bolts as directed. Prematurely tightening the bolts can lead to numerous issues and will lengthen the assembly time. Listed below are the most common issues in chair assembly and their easy solutions.

PROBLEM: Chair is unlevel.

Cause 1:

Unlevel chairs can occur if the bolts are fully tightened before all bolts are attached. There is a variance in the alignment of this chair to allow the chair to be assembled more easily.

Solution:

Loosen each bolt in the seat box (front legs, back corner blocks and back apron) until they are finger tight. Place the chair upright on the floor. Sit in the chair for about 30 seconds. Carefully turn the chair upside down and tighten each bolt. The chair will now be level.

Cause 2:

Unlevel chairs can occur if one or more of the floor glides are missing from the bottom of the chair leg.

Solution:

Request a set of floor glides from the e-mail address below.

AR@ssilver.com

PROBLEM: Bolts do not fit properly.

Cause:

This issue can occur when the bolts are tightened fully before all bolts are attached. There is a variance in the alignment of the bolts to allow the chair to be assembled more easily. Tightening the bolts prematurely can cause the holes for the other bolts to become slightly misaligned, causing the remaining bolts not to fit properly.

Solution:

Make sure each bolt in the seat box (front legs, back corner blocks and back apron) is loosened until finger tight. This will allow you to realign the holes, and the bolts will now fit properly.

Questions?

Please call us at 1 800 344 7278, and we will be happy to help you.