

Assembly | Asamblea | Assemblage

PO#

Customer service | Servicio al cliente | Service clientèle: 800.633.5096

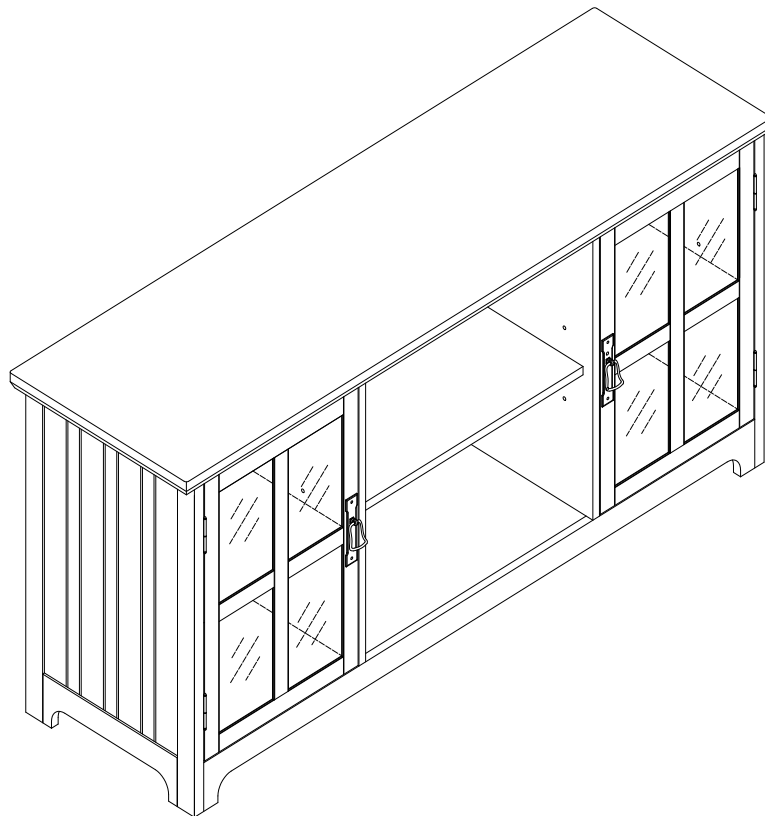

Product number | Número de producto | Numéro de produit

MS9907

MS9908

Thank you for your purchase! | ¡Gracias por tu compra! | Merci pour votre achat!

Assembly | Asamblea | Assemblage

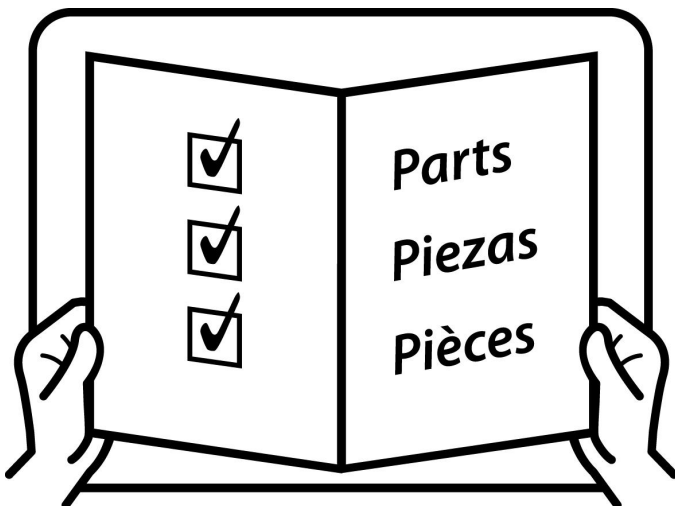
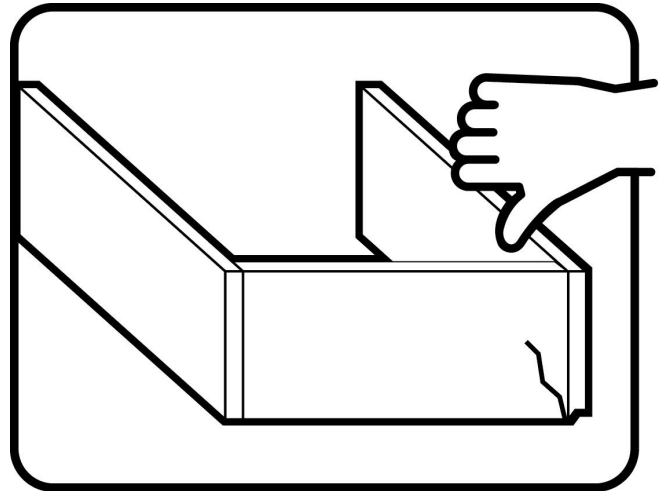
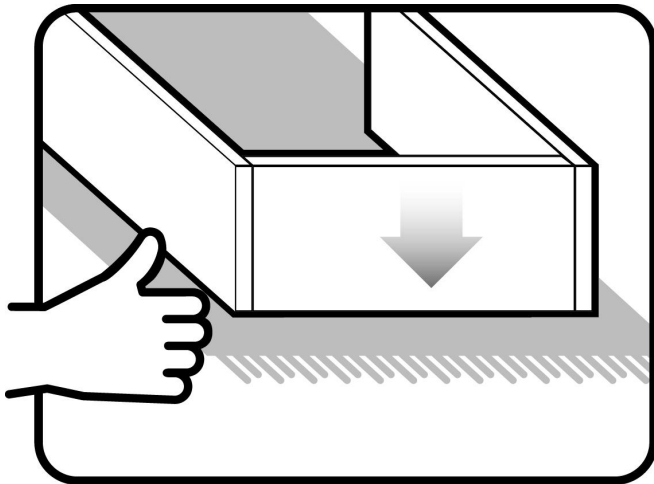
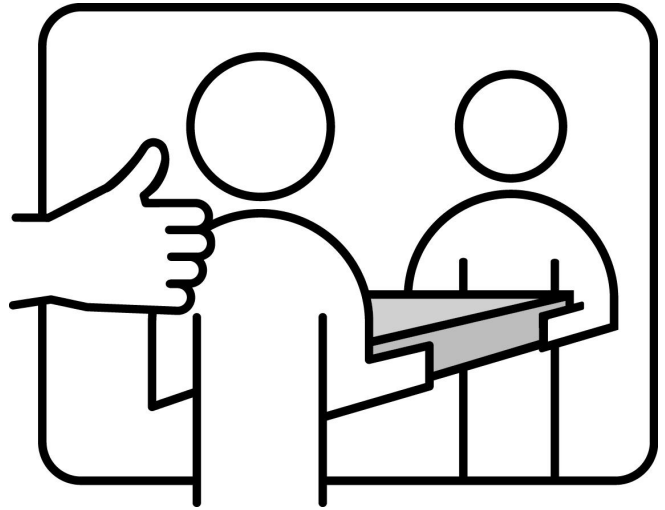
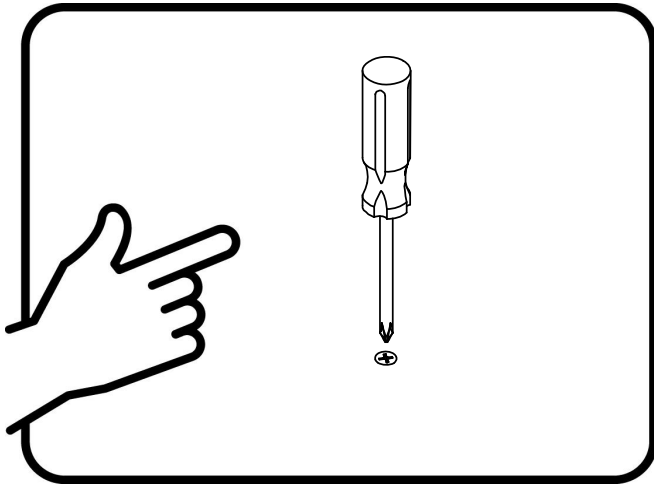

Assembly | Asamblea | Assemblage

Techniques | Técnicas | Techniques

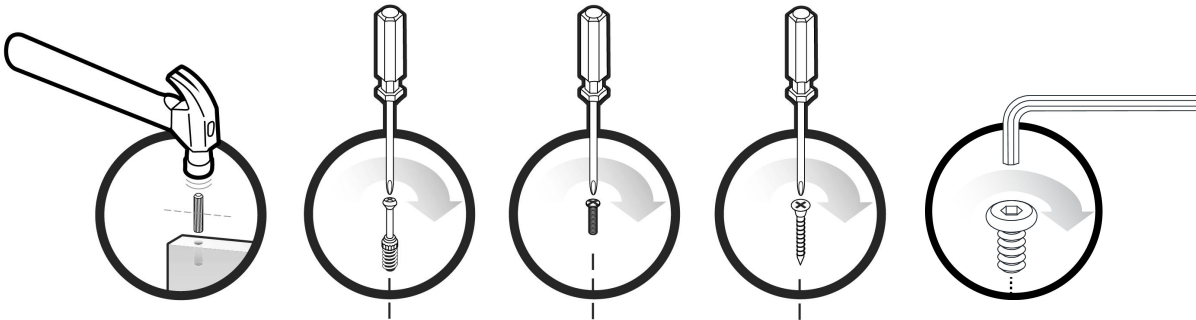

Care | Cuidado | Entretien



Safety | Seguridad | Sécurité









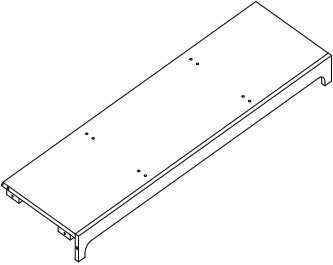
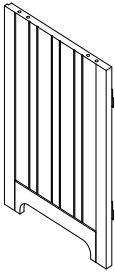
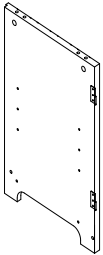
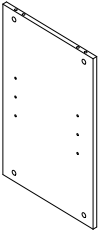
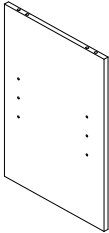
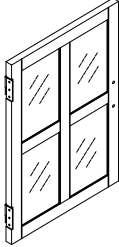
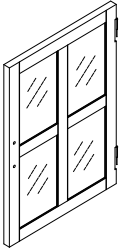
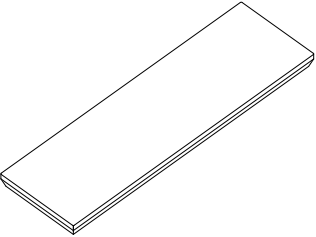
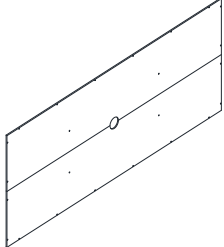
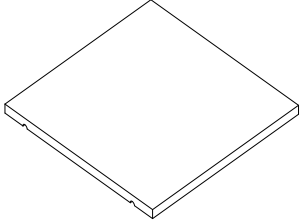
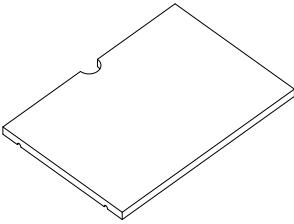
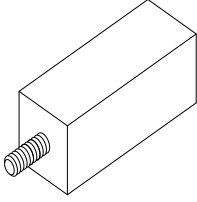

Note! | ¡Nota! | Remarque!

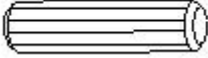
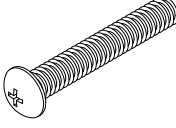

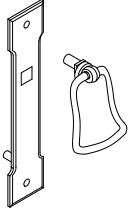
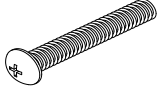
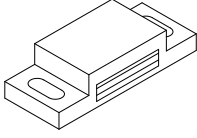
Assembly | Asambla | Assemblage

<p>A Quantity of 1</p>  <p>Bottom</p>	<p>B Quantity of 1</p>  <p>Left side panel</p>	<p>C Quantity of 1</p>  <p>Right side panel</p>
<p>D Quantity of 1</p>  <p>Left middle side panel</p>	<p>E Quantity of 1</p>  <p>Right middle side panel</p>	<p>F Quantity of 1</p>  <p>Left door</p>
<p>G Quantity of 1</p>  <p>Right door</p>	<p>H Quantity of 1</p>  <p>Top panel</p>	<p>I Quantity of 1</p>  <p>Back panel</p>
<p>J Quantity of 2</p>  <p>Small shelf</p>	<p>K Quantity of 1</p>  <p>Big shelf</p>	<p>L Quantity of 1</p>  <p>Middle leg</p>

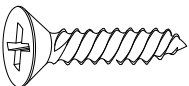
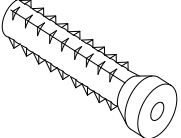

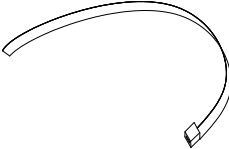
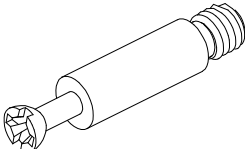
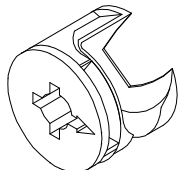
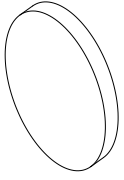

Assembly | Asamblea | Assemblage

<p>1</p>  <p>Quantity of 16</p> <p>Wood Dowel (Ø8*30)</p>	<p>2</p>  <p>Quantity of 4</p> <p>Bolt (Ø1/4"*1-1/4")</p>	<p>3</p>  <p>Quantity of 4</p> <p>Flat washer</p>
<p>4</p>  <p>Quantity of 2</p> <p>Handle</p>	<p>5</p>  <p>Quantity of 4</p> <p>Bolt (Ø5/32"*1-1/8")</p>	<p>6</p>  <p>Quantity of 2</p> <p>Magnet</p>
<p>7</p>  <p>Quantity of 28</p> <p>screw Ø1/8"x5/8"L</p>	<p>8</p>  <p>Quantity of 12</p> <p>Shelf holder</p>	<p>9</p>  <p>Quantity of 4</p> <p>Bracket</p>
<p>10</p>  <p>Quantity of 4</p> <p>Screw Ø1/8"x5/8"L</p>	<p>11</p>  <p>Quantity of 4</p> <p>Anchor</p>	<p>12</p>  <p>Quantity of 4</p> <p>Screw Ø1/8"*1-1/2"L</p>
<p>13</p>  <p>Quantity of 2</p> <p>Tie</p>	<p>14</p>  <p>Quantity of 12</p> <p>Cam bolt</p>	<p>15</p>  <p>Quantity of 12</p> <p>Cam lock</p>
<p>16</p>  <p>Quantity of 12</p> <p>Cover</p>		

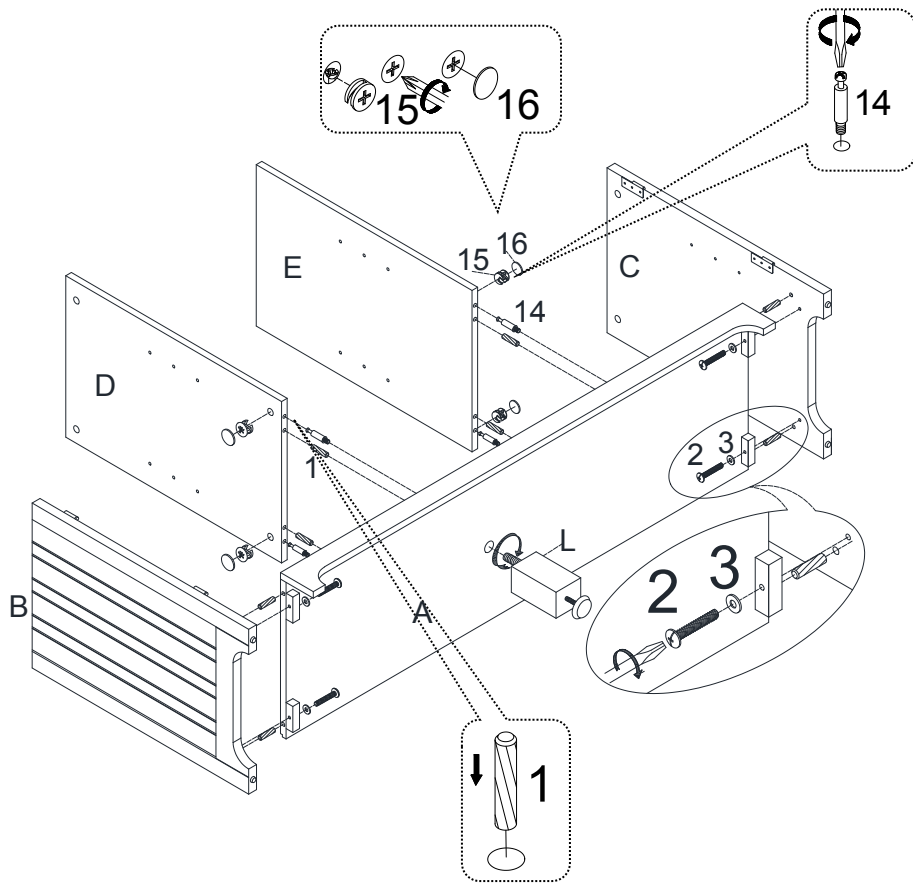
Assembly | Asambla | Assemblage

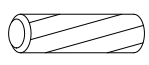
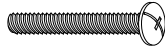
1

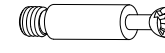

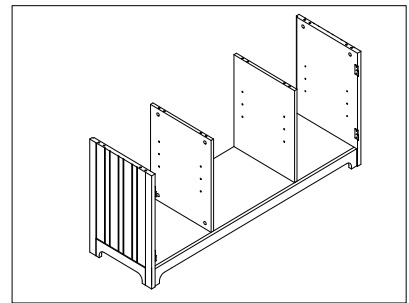

1		x8
2		x4
3		x4
14		x4
15		x4
16		x4

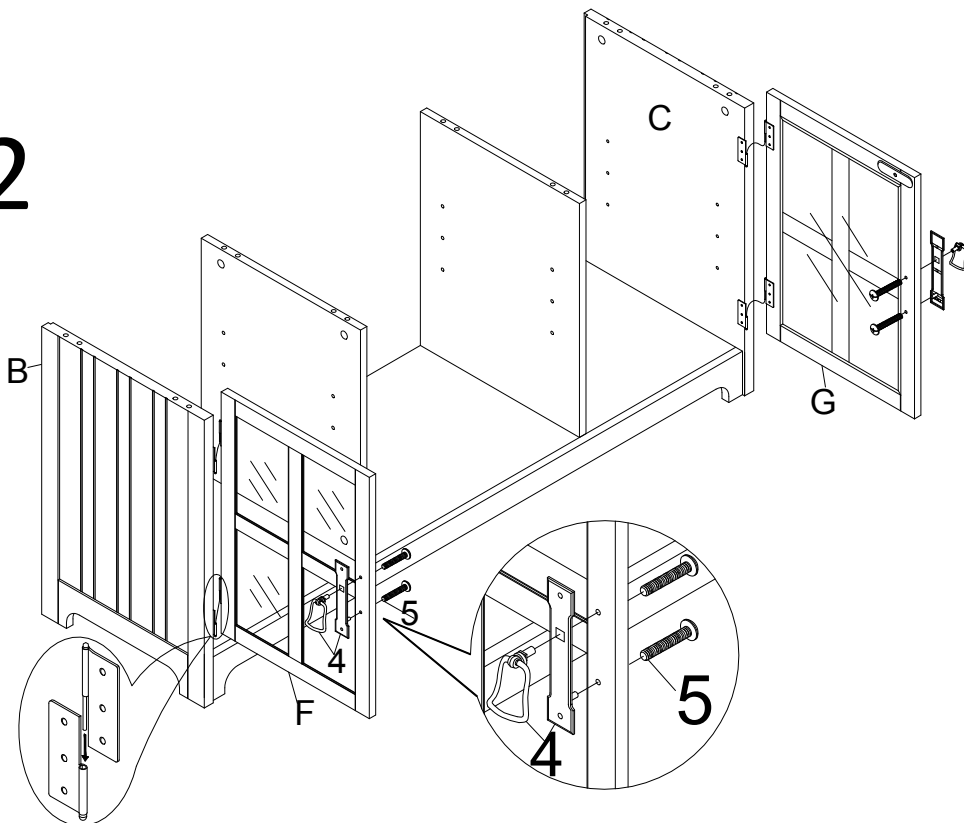

2



4		x2
5		x4

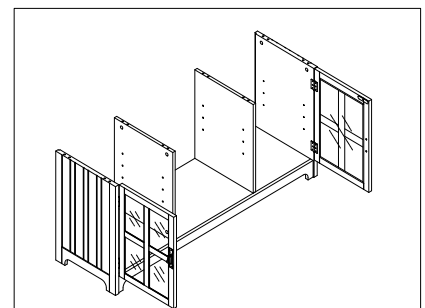

Assembly | Asambla | Assemblage

3

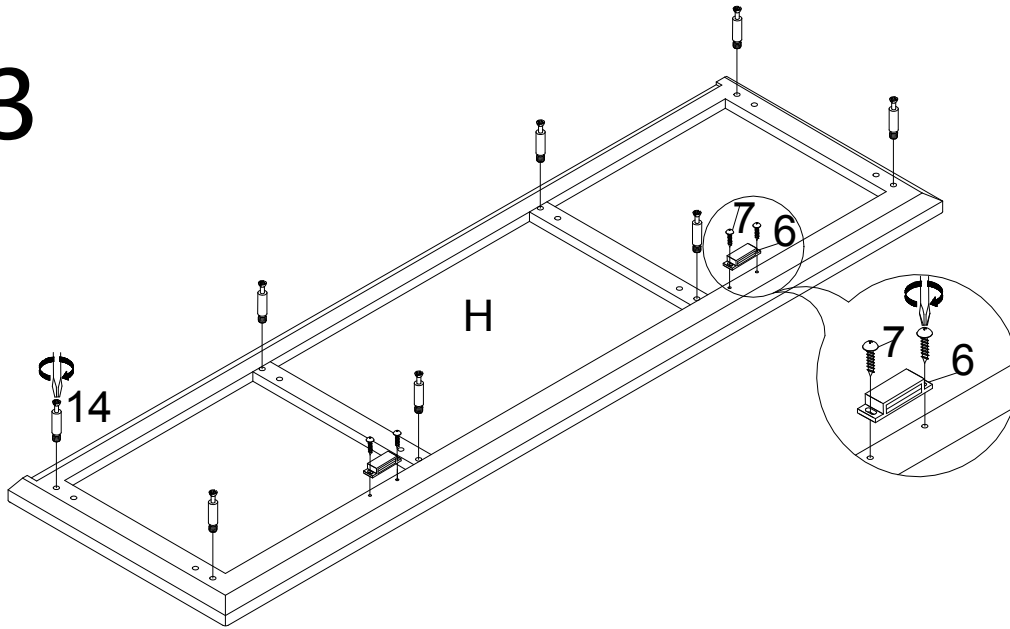

6		x2
7		x4
14		x8

4

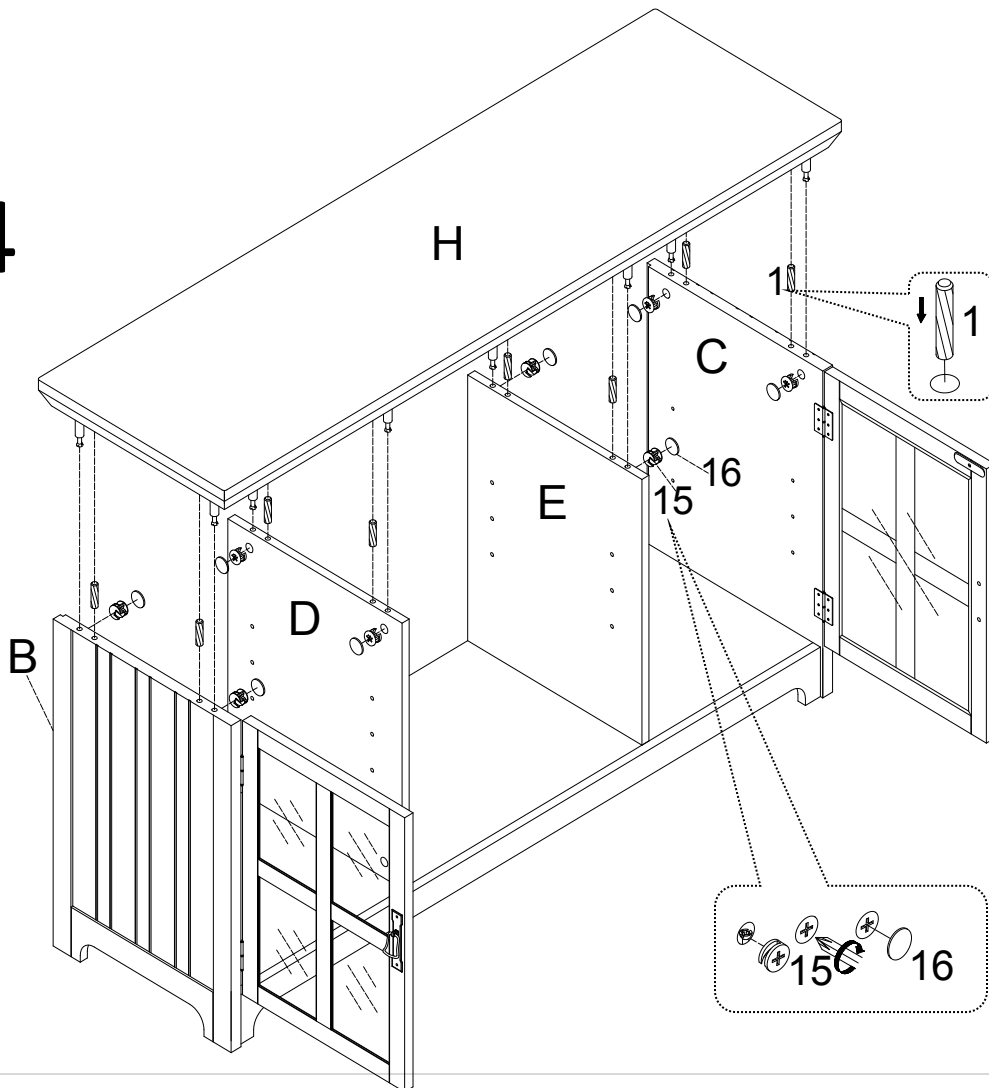

1		x8
15		x8
16		x8

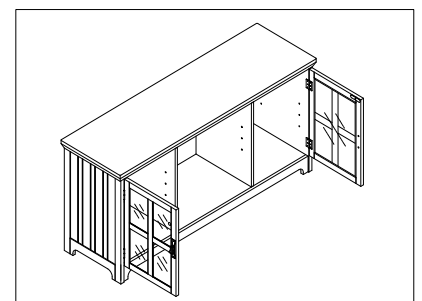

Assembly | Asambla | Assemblage

5

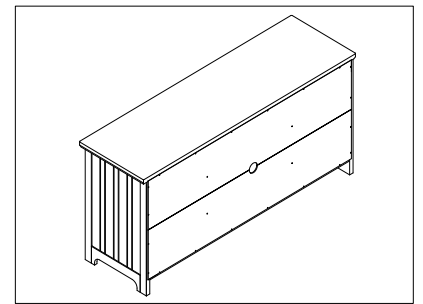
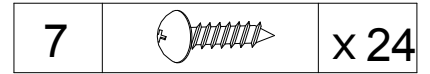
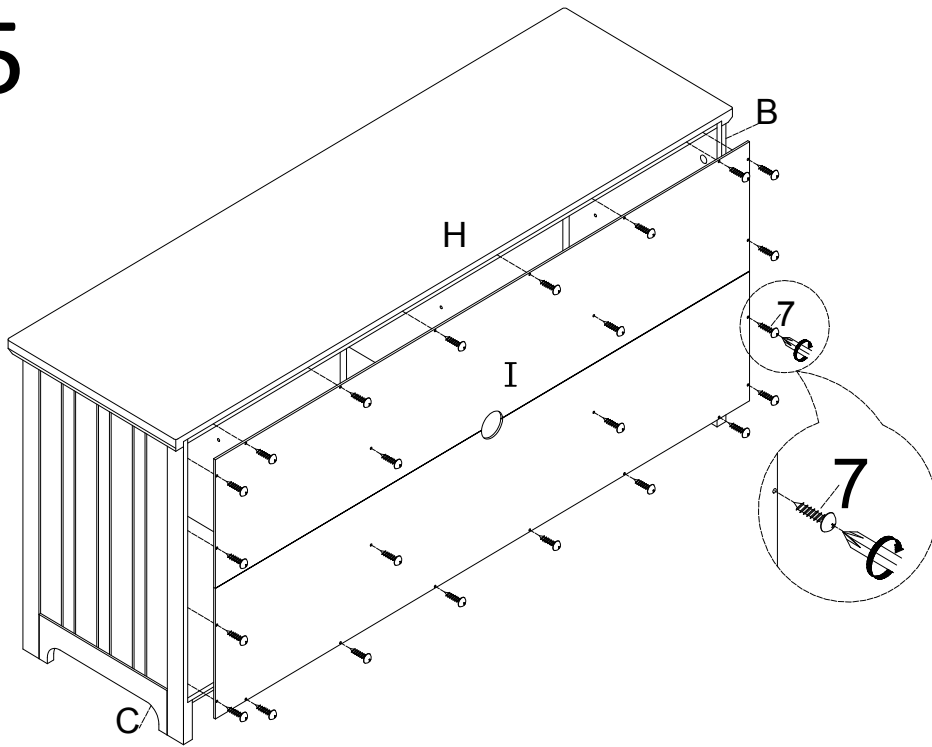

6

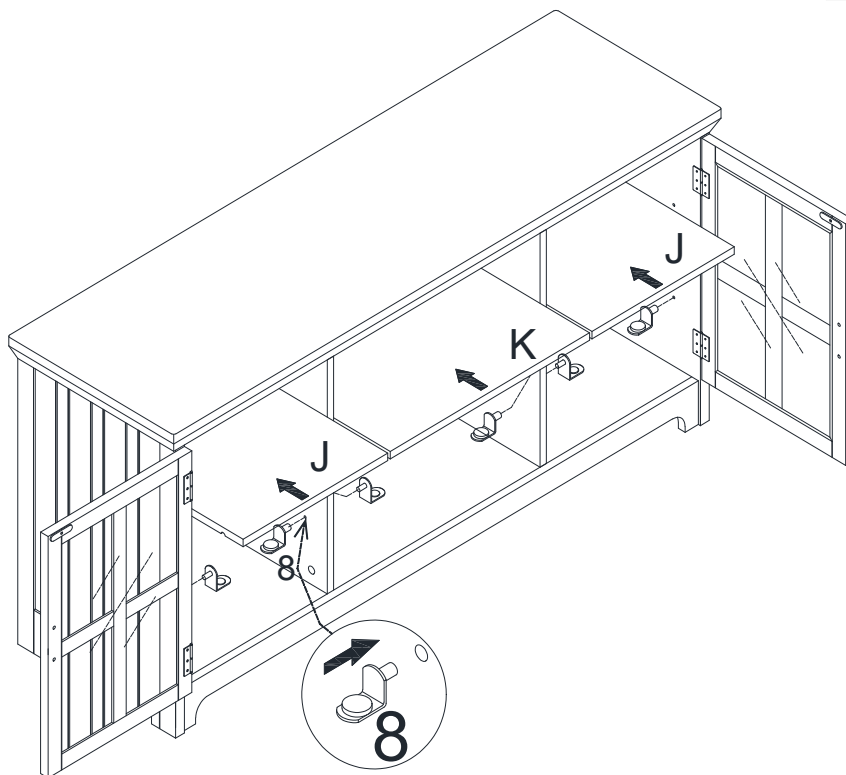

Assembly | Asambla | Assemblage

7

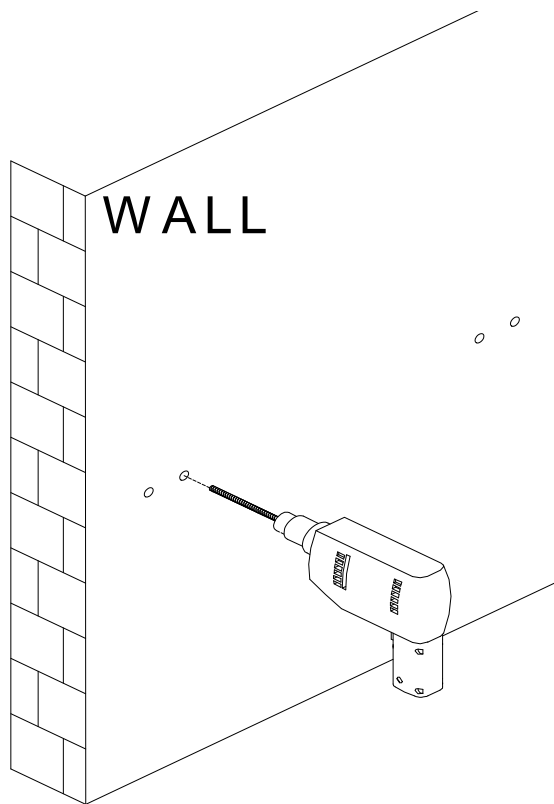

8

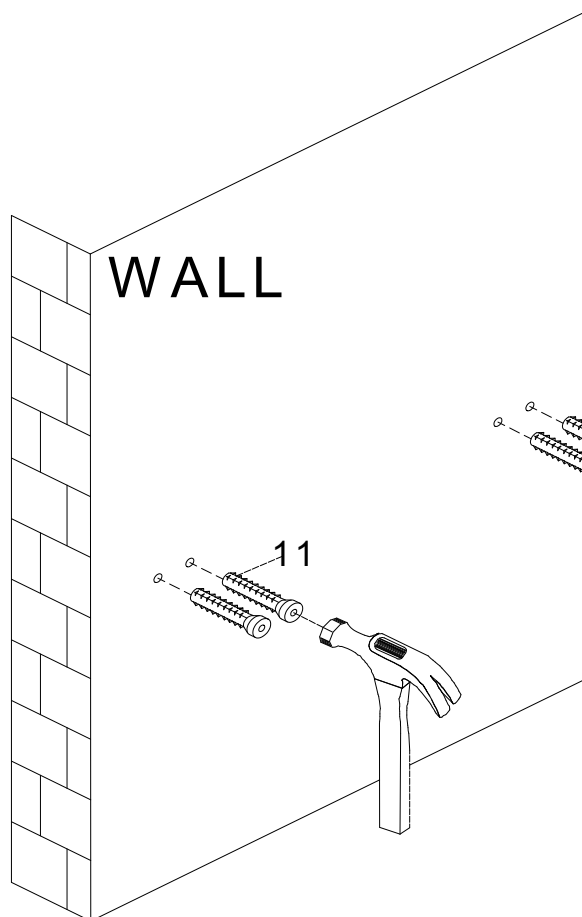

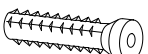

11		x 4
----	---	-----

Assembly | Asambla | Assemblage

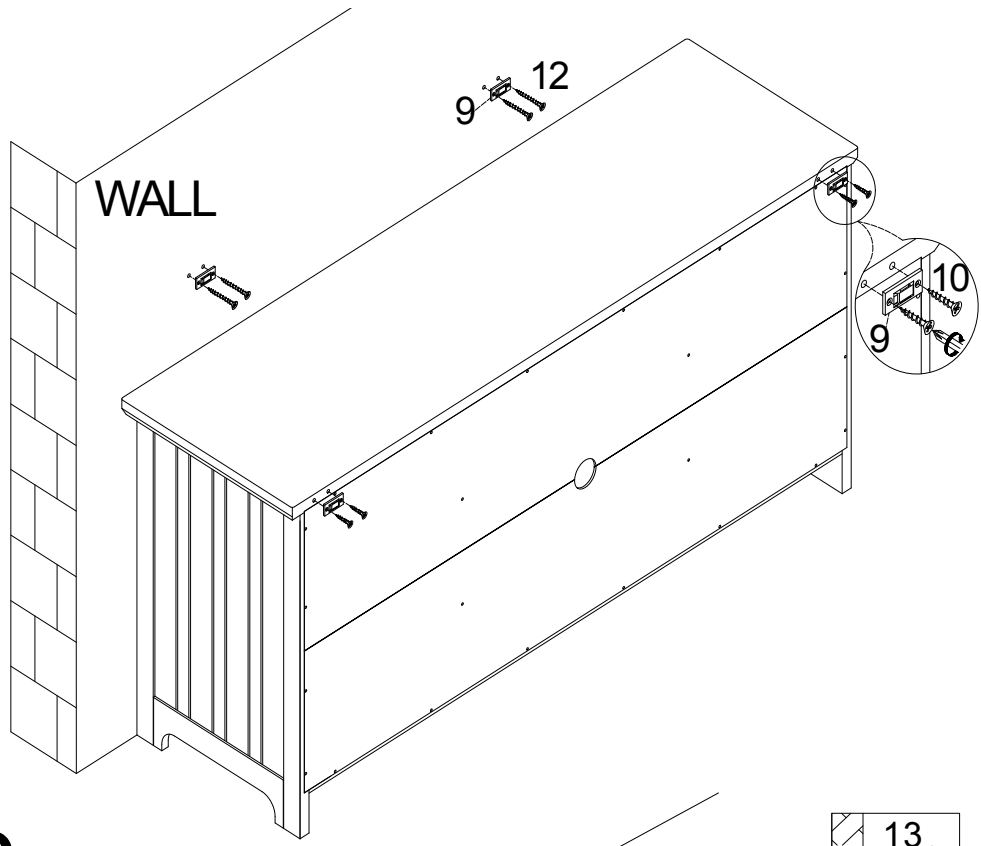
9

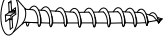

9		x 4
10		x 4
12		x 4

10

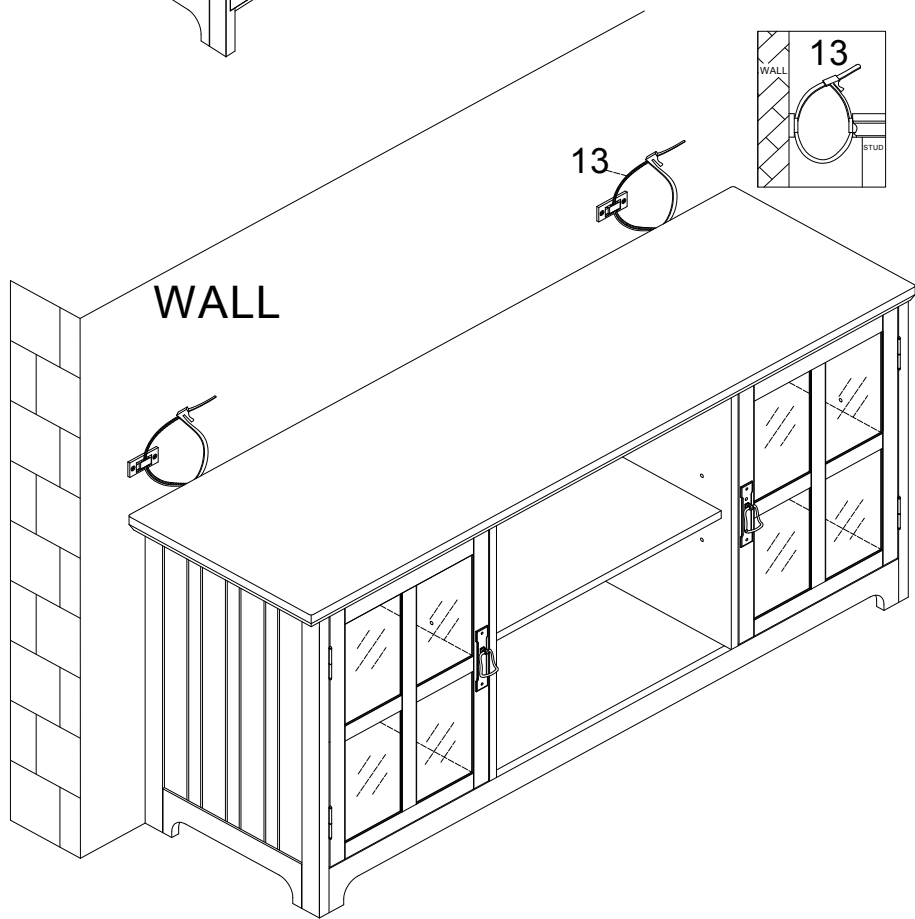

13		x 2
----	---	-----

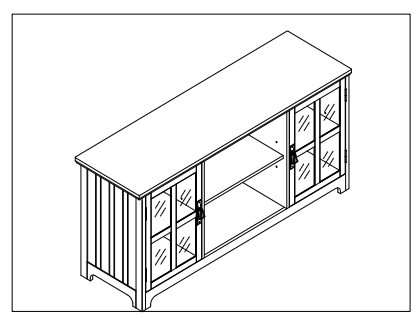

Assembly | Asamblea | Assemblage

May We Help You? 800.633.5096

Please have this information ready when you call:

- Item Number
- PO #
- Purchaser Name
- Place of Purchase
- Purchase Date
- Date Product Arrived

Immediately examine this product carefully. Any request for missing or damaged part replacement must be received within 90 days of your receipt of the product. Requests for replacement parts, if available, will be honored within this time frame. Parts will not be available for items arriving fully assembled. We do not recommend modifying products and we are not responsible for any damages due to product modifications. If damages or missing parts are not reported within 90 days of receiving the product, we are under no obligation to provide parts or replacement merchandise. For product issues, please contact customer service at 800-633-5096 (toll-free) Mon-Fri 8:30am – 5pm CST. Please ask for a customer service representative for issues involving damages or replacement parts. Please ask for a technical assistance representative for any issues related to product assembly/construction. Regarding product returns, please contact the retailer from whom you purchased the product.

Please note, for items purchased in a retail store, you will need to contact the retailer for all part needs.

Products purchased at garage sales or discount stores are sold as-is and are not covered by the above warranty

¿Podemos ayudarle? 800.633.5096

Tenga a mano esta información cuando llame:

- Número de artículo
- PO #
- Nombre del comprador
- Lugar de compra
- Fecha de compra
- Fecha en que llegó el producto

Inmediatamente examine este producto con cuidado. Cualquier solicitud de reemplazo de piezas faltantes o dañadas debe recibirse dentro de los 90 días posteriores a la recepción del producto. Las solicitudes de repuestos, si están disponibles, serán atendidas dentro de este marco de tiempo. Las piezas no estarán disponibles para los artículos que lleguen completamente ensamblados. No recomendamos modificar los productos y no nos hacemos responsables de los daños debidos a las modificaciones del producto. Si no se informan daños o piezas faltantes dentro de los 90 días de haber recibido el producto, no estamos obligados a proporcionar piezas o productos de reemplazo. Para problemas con el producto, comuníquese con el servicio al cliente al 800-633-5096 (sin cargo) de lunes a viernes, de 8:30 a. M. A 5 p.m. CST. Solicite a un representante de servicio al cliente si tiene problemas con daños o piezas de repuesto. Solicite un representante de asistencia técnica para cualquier problema relacionado con el montaje / construcción del producto. Con respecto a las devoluciones de productos, comuníquese con el vendedor al que le compró el producto.

Tenga en cuenta que, para los artículos comprados en una tienda minorista, deberá comunicarse con el minorista para todas las necesidades de piezas.

Los productos comprados en las ventas de garaje o tiendas de descuento se venden tal como están y no están cubiertos por la garantía anterior.

Pouvons-nous vous aider? 800.633.5096

Veillez avoir cette information à portée de main lorsque vous appelez:

- Numéro d'article
- PO #
- Nom de l'acheteur
- Lieu d'achat
- Date d'achat
- Date d'arrivée du produit

Immédiatement examiner ce produit soigneusement. Toute demande de remplacement de pièce manquante ou endommagée doit être reçue dans les 90 jours suivant la réception de votre produit. Les demandes de pièces de rechange, si elles sont disponibles, seront honorées dans ce délai. Les pièces ne seront pas disponibles pour les articles arrivant complètement assemblés. Nous ne recommandons pas de modifier les produits et nous ne sommes pas responsables des dommages causés par des modifications du produit. Si les dommages ou les pièces manquantes ne sont pas signalés dans les 90 jours suivant la réception du produit, nous ne sommes pas tenus de fournir des pièces ou des produits de remplacement. En cas de problème avec le produit, veuillez contacter le service clientèle le 800-633-5096 (sans frais) du lundi au vendredi de 8h30 à 17h, heure de Paris. S'il vous plaît demander à un représentant du service clientèle pour les problèmes impliquant des dommages ou des pièces de rechange. Veuillez demander à un représentant de l'assistance technique de résoudre tout problème lié à l'assemblage / la construction du produit. En ce qui concerne les retours de produits, veuillez contacter le détaillant chez qui vous avez acheté le produit.

Veillez noter que pour les articles achetés dans un magasin de détail, vous devrez contacter le détaillant pour tous les besoins en pièces.

Les produits achetés dans les vide-greniers ou les magasins à prix réduits sont vendus tels quels et ne sont pas couverts par la garantie ci-dessus.