

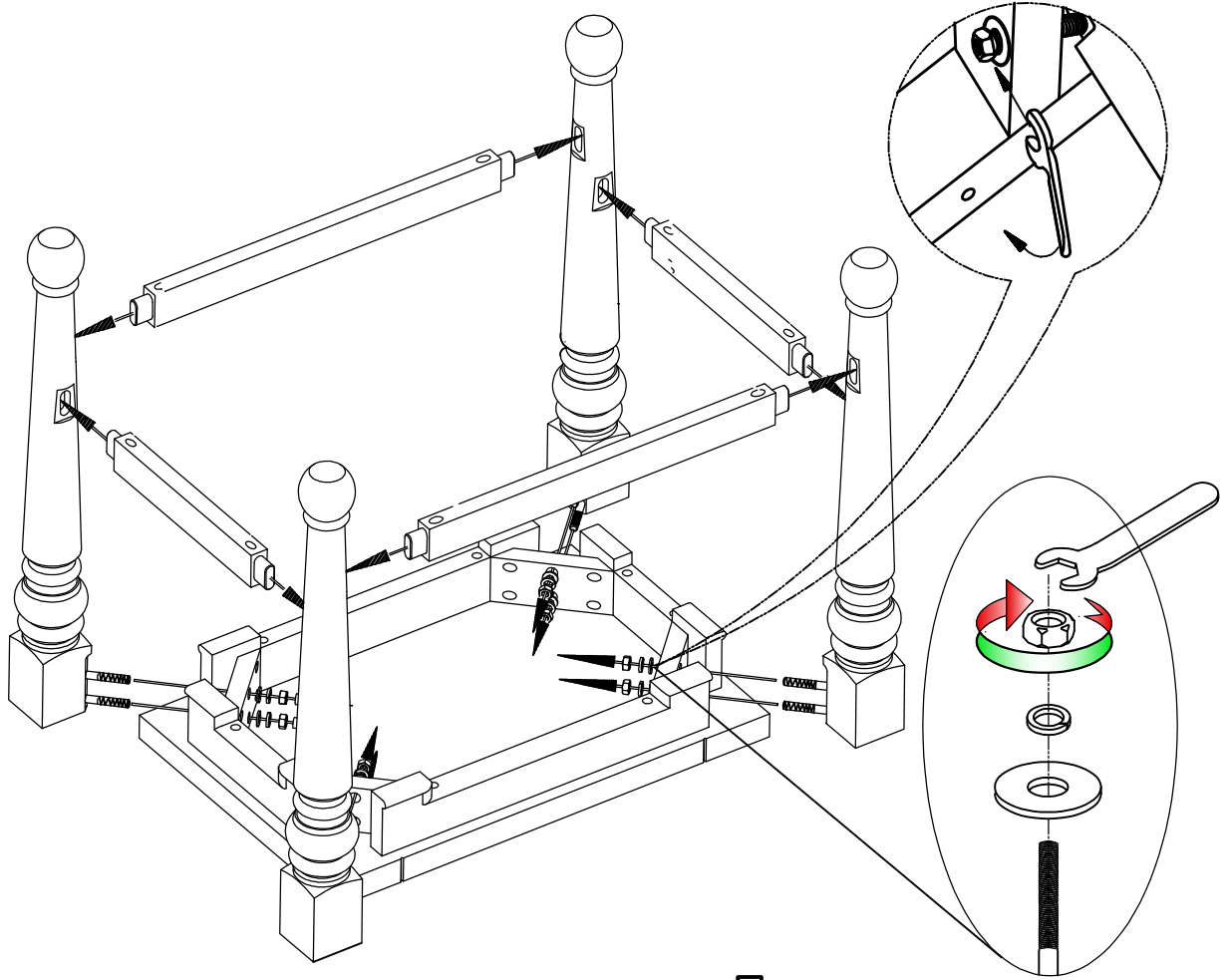

SUNNY DESIGNS

#1433FC-24W--Assembly Instruction





1

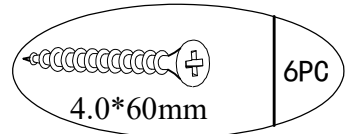

2



Hardware List

Description	QTY
 5/16"*13mm	8PC
 5/16"*22mm	8PC
 NUT 5/16"*12mm*6mm	8PC
 5/16"(12)*87mm	1PC
 4.0*60mm	8PC
Total	33pcs

