

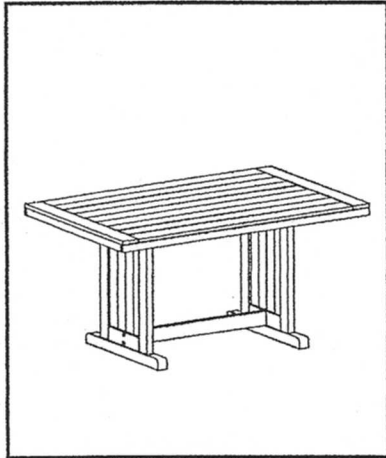





ASSEMBLY INSTRUCTIONS #0113-T



HARDWARE LIST

NO	SKETCH	HARDWARE	QTY
1		JCBC M8 x 50mm	16 pcs
2		Allen Key	1 pc

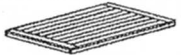
PART LIST

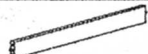
NO	DESCRIPTION	SKETCH	QTY
A	Table Top		1 pc
B	Assembly Base		2 pcs
C	Wood Strecher		2 pcs

ASSEMBLY STEP

STEP 1

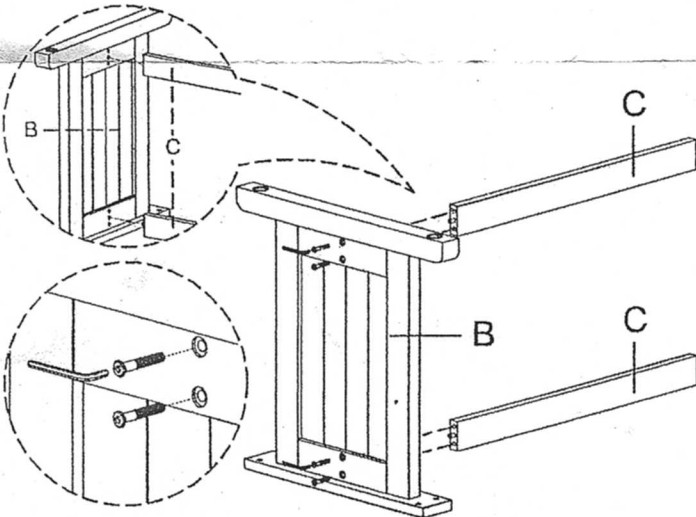

STEP 2

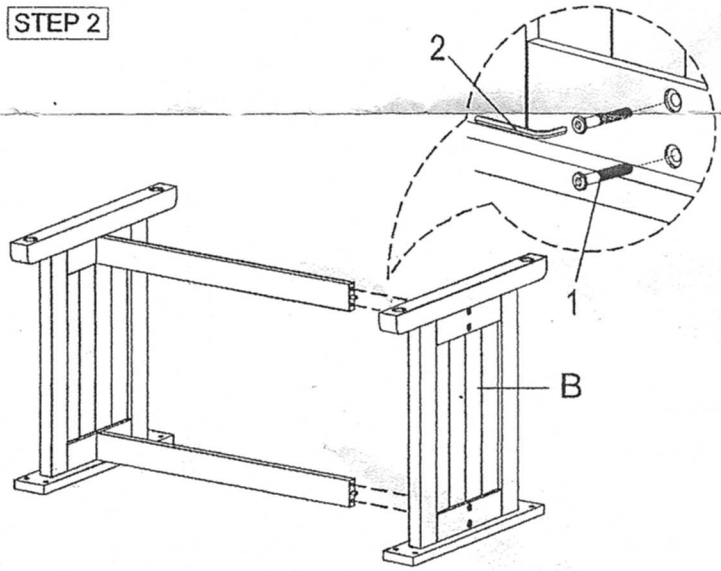

STEP 3

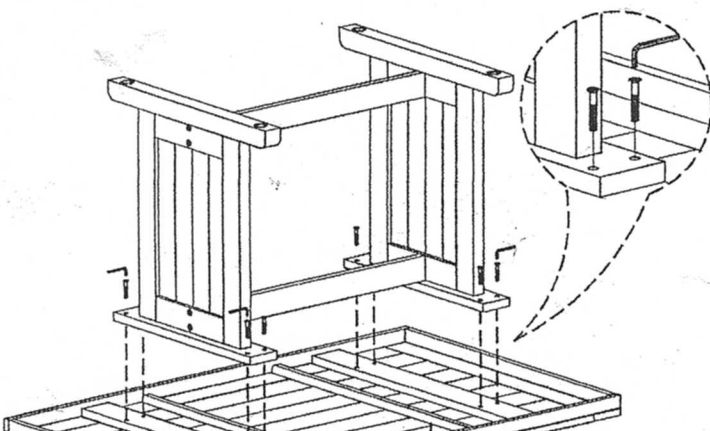

FINISH

