

PARTS LIST / LISTE DES PIÈCES / LISTA DE PIEZA

ITEM / NO D'ARTICLE / ARTICULO.: S958-041

Description/ La Description / Descripción : Gents Chest/Coffre pour hommes/Cofre de caballeros

⚠ WARNING	
	<p>Children have died from furniture tipover. To reduce the risk of furniture tipover:</p> <ul style="list-style-type: none"> - ALWAYS install anti-tip device provided. - NEVER put a TV on this product. - NEVER allow children to stand, climb, or hang on any drawers, doors, or shelves. - NEVER open more than one drawer at a time. - Place heaviest items in the lowest drawers. <p><i>This is a permanent label. Do not remove!</i></p>
	

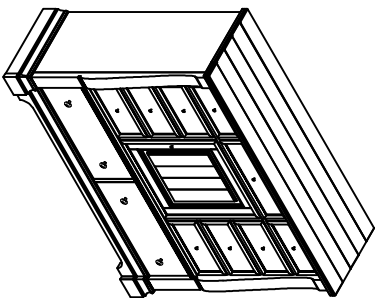
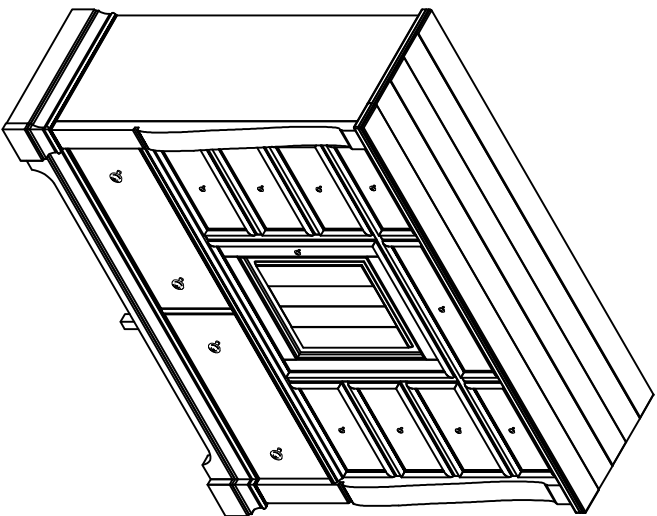

A

- x1 Gents Chest
- x1 Coffre pour hommes
- x1 Cofre de caballeros



B

- x1 Furniture Tipping Restraint
- x1 Système antibasculement
- x1 Control para evitar vuelcos

*

*Replaceable Part

ASSEMBLY INSTRUCTION / NOTICE DE MONTAGE / INSTRUCCIONES DE MONTAJE

ITEM / NO D'ARTICLE / ARTICULO.: S958-041

Description/ La Description / Descripción : Gents Chest/Cofre pour hommes/Cofre de caballeros

	
<p>⚠ WARNING</p> <p>Children have died from furniture tipover. To reduce the risk of furniture tipover:</p> <ul style="list-style-type: none"> - ALWAYS install anti-tip device provided. - NEVER put a TV on this product. - NEVER allow children to stand, climb, or hang on any drawers, doors, or shelves. - NEVER open more than one drawer at a time. - Place heaviest items in the lowest drawers. <p><i>This is a permanent label. Do not remove!</i></p>	

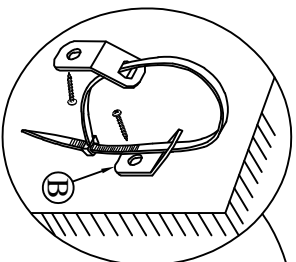

Furniture Tipping Restraint
Système antibasculement
Control para evitar vuelcos

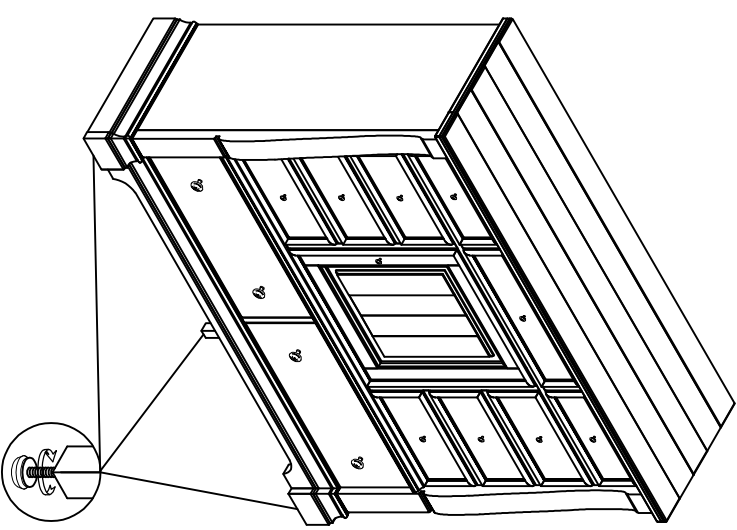
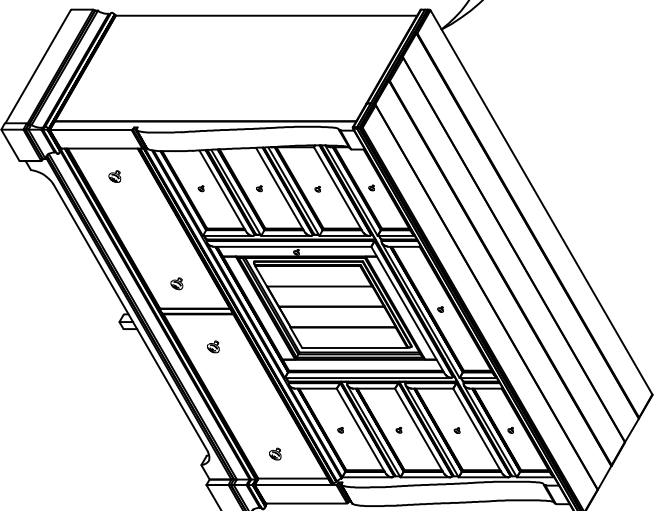

Adjustable leveler
Patin réglable
Nivelador ajustable

*Replaceable Part







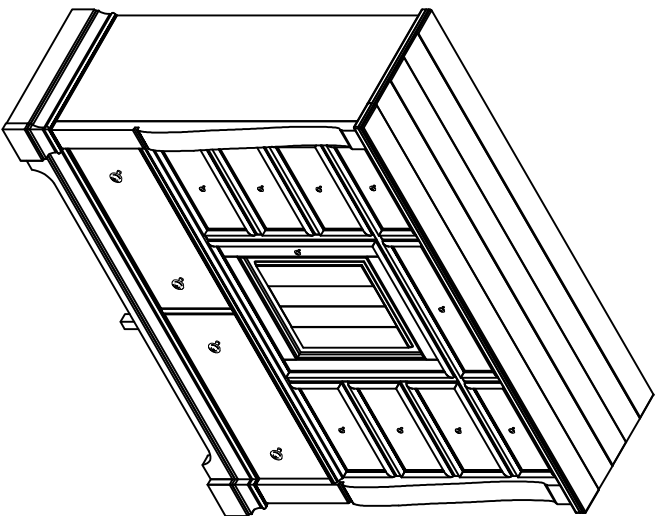

REPLACEABLE PART / PARTIE REMPLACABLE / PARTE REEMPLAZABLE

ITEM / NO D'ARTICLE / ARTICULO.: S958-041

Description/ La Description / Descripción : Gents Chest/Cofre pour hommes/Cofre de caballeros

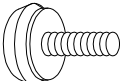
	⚠ WARNING
	
<p>Children have died from furniture tipover. To reduce the risk of furniture tipover:</p> <ul style="list-style-type: none"> - ALWAYS install anti-tip device provided. - NEVER put a TV on this product. - NEVER allow children to stand, climb, or hang on any drawers, doors, or shelves. - NEVER open more than one drawer at a time. - Place heaviest items in the lowest drawers. <p><i>This is a permanent label. Do not remove!</i></p>	

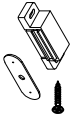

- | | | | | | |
|--|---|---|---|--|---|
|  | * |  | * |  | * |
| x4 RS958-010-KNOBS-Big Knob with Screw
Poignée + Vis
Tirador + Tornillo | | x11 COMGLIDE-10-45 - Drawer Glide
Glisiera de tiroir
Deslizamiento del cajón | | x1 RC-ANTI-TIP-Furniture Tipping Restraint
Système antibasculement
Control para evitar vuelcos | |
|  | * |  | * |  | * |
| x10 RS958-010-KNOBS-Small Knob with Screw
Poignée + Vis
Tirador + Tornillo | | x2 RC-BR-NAIL- Brown Plastic nail
clou en plastique
clavo de plástico | | x3 RC-FG-BROWN-Brown leveler
Niveladora marron
Niveleur marron | |
|  | * |  | * |  | * |
| x4 RS958-041-PIN-Sheif pin
Épingle
Estantiera | | x1 RS958-041-CATCH-Magnetic Catch
Loquet magnétique
Captura magnética | | x2 RS958-041-HINGE-Door Hinge
Bisagra de la puerta
Charnière de porte | |
|  | * | | | | |
| x1 RS958-041-SHELF-Wood Shelf
Étagère centrale en bois
Estante central de madera | | | | | |

* Replaceable Part

Protect Your Wood or Laminate Flooring

*This statement applies to any floor without carpet.

If not careful, all furniture including upholstery and case pieces can scratch, scuff and even gouge floors. The recommendation is to have felt, rubber pads or area rugs under furniture on flooring without carpet.

Moving your furniture

Pushing and dragging furniture over floors without carpet can lead to scratches and scuffs. Have someone help when moving the larger pieces of furniture by lifting, try using a dolly or moving pads.

Felt and rubber pads

Applying furniture pads to the feet of furniture helps cushion contact points. Furniture pads can be found at local hardware stores. Felt pads slide easily across the floor, making them ideal for dining chairs and other pieces that move with use. Rubber pads will help furniture stay in place and are perfect for larger pieces, like sofas and loveseats.

Area rugs and rug pads

Using an area rug under furniture is another way to protect your floor from scratches and scuff marks. A rug pad under the area rug will provide extra cushion and added protection.