

- x1 Chair Back
- x1 Dossier de chaise
- x1 Respaldo de silla

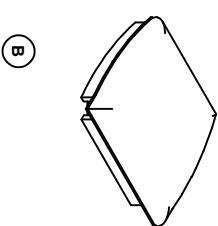

- x1 Seat Frame with Cushion
- x1 Cadre de siège avec coussin
- x1 Armazón del asiento con cojín

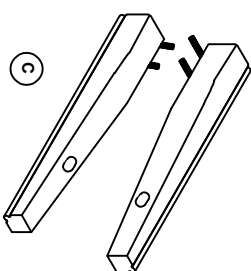

- x2 Front Leg (Left & Right)
- x2 Jambes avant (gauche et droite)
- x2 Pata delantera (izquierda y derecha)

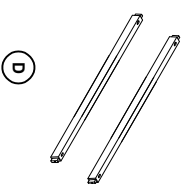

- x2 Stretcher (Left & Right)
- x2 Tenduse (gauche et droite)
- x2 Camilla (izquierda y derecha)

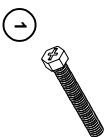
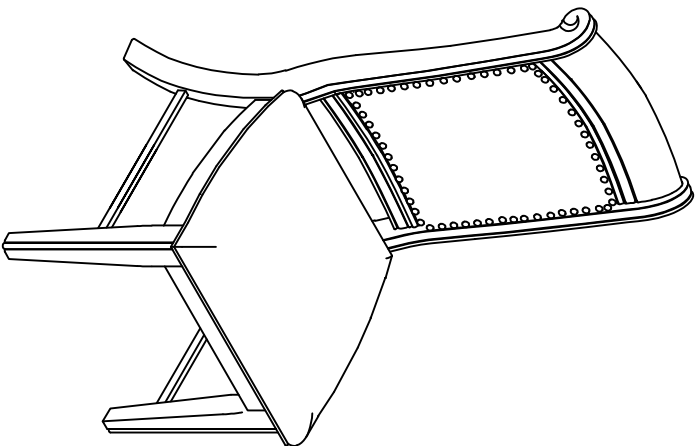

- x4 Allen bolt Ø5/16 " \* 75mm
- x4 Vis à tête creuse hexagonale Ø5/16 " \* 75mm
- x4 Perno Allen Ø5/16 " \* 75mm



- x2 Allen bolt Ø5/16 " \* 40mm
- x2 Vis à tête creuse hexagonale Ø5/16 " \* 40mm
- x2 Perno Allen Ø5/16 " \* 40mm

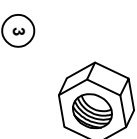

- x4 Hex nut 12\*12\*6mm
- x4 Écrou hexagonal 12\*12\*6mm
- x4 Tuercas hexagona 2\*12\*6mm

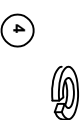

- x10 Lock washer Ø5/16" \* 13\*2mm
- x10 Rondelle de blocage Ø5/16" \* 13\*2mm
- x10 Arandela de Seguridad Ø5/16" \* 13\*2mm



- x10 Flat washer Ø5/16" \* 19\*2mm
- x10 Rondelle plate Ø5/16" \* 19\*2mm
- x10 Arandela plana Ø5/16" \* 19\*2mm



- x1 Open wrench 12mm
- x1 Clé à fourche 12mm
- x1 Llave de boca 12mm



- x4 Wood Screw #8\*50mm
- x4 Vis à bois #8\*50mm
- x4 Tornillo para madera #8\*50mm

\*Replaceable Part

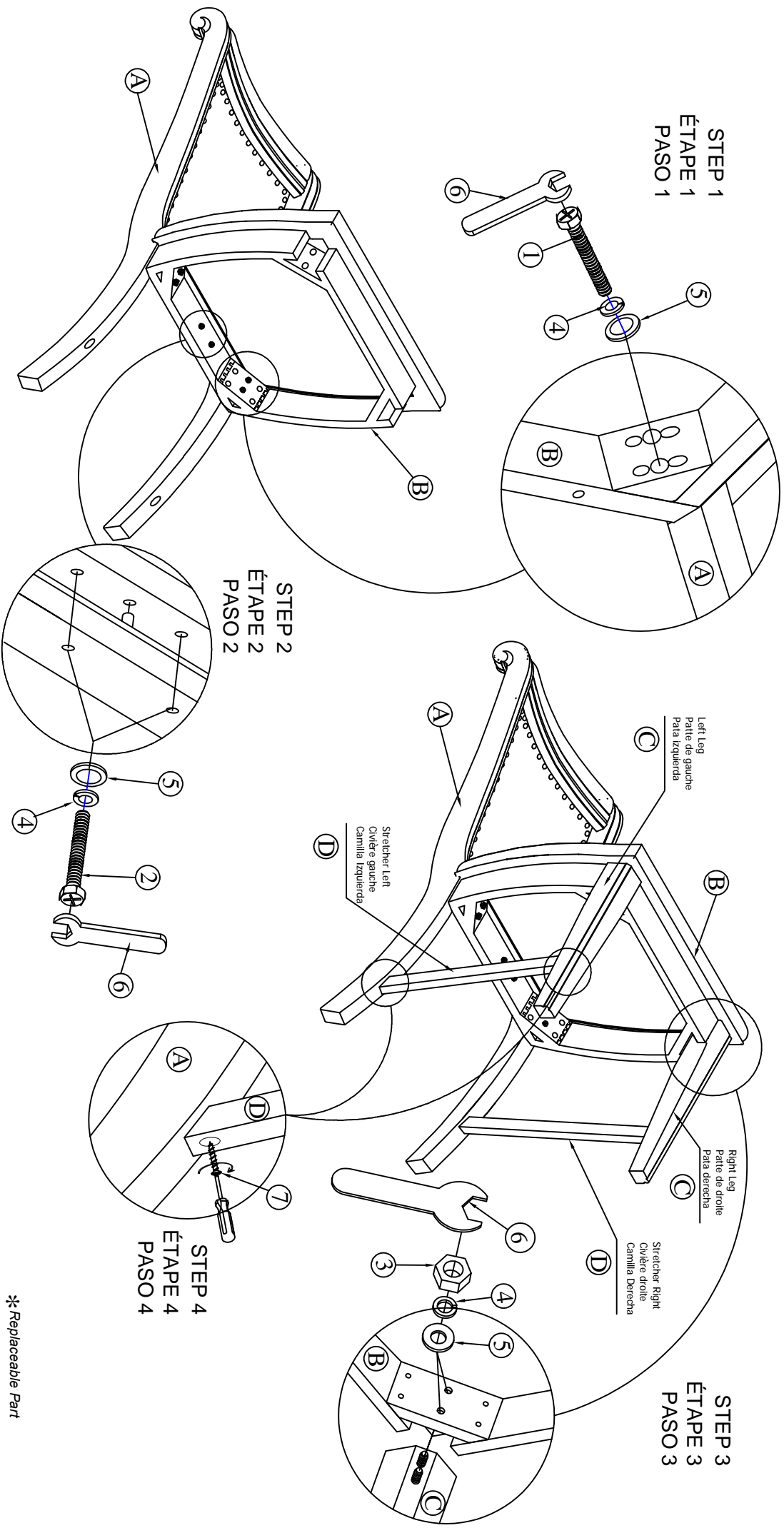

\*Replaceable Part

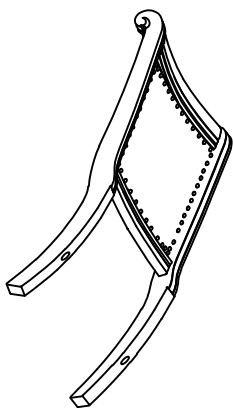

x1 RS958-154-BACK-Chair Back  
 Dossier de chaise  
 Respaldo de silla

\*

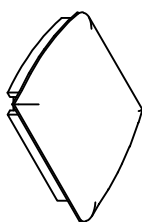

x1 RS958-154-SEAT-Seat Cushion with Frame  
 Cadre de siège avec coussin  
 Armazón del asiento con cojín

\*

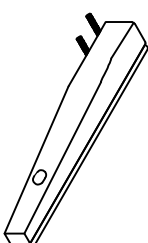

x1 RS958-154-LEGL-Left Leg  
 Jambé avant gauche  
 Pata delantera izquierda

\*

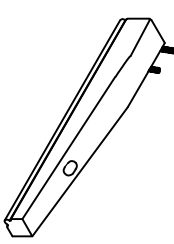

x1 RS958-154-LEGR-Right Leg  
 Jambé avant droite  
 Pierna delantera derecha

\*

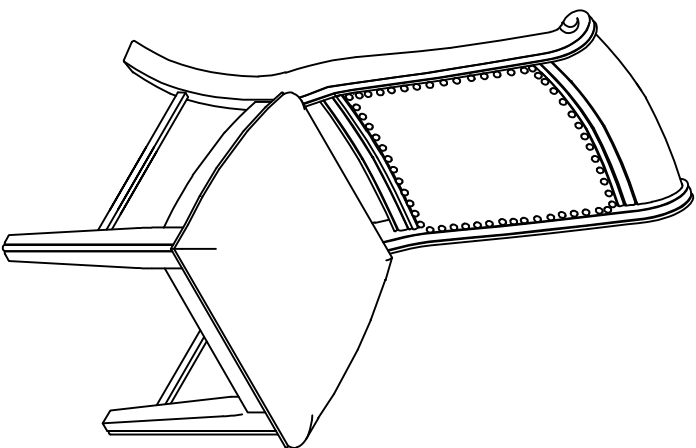

x1 RS958-154-STRETCHERL-Left  
 Civière gauche  
 Camilla Izquierda

\*



x1 RS958-154-STRETCHERR-Right  
 Civière droite  
 Camilla Derecha

\*

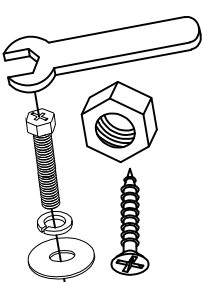

x1 RS958-154-HWKIT-Hardware kit list  
 Liste des pièces de quincailleries  
 Lista del kit de materiales

\*



x4 RC-WH-NAIL- White Plastic nail  
 Clou en plastique  
 Clavo de plástico

\*

**\*Replaceable Part**

## **Protect Your Wood or Laminate Flooring**

\*This statement applies to any floor without carpet.

If not careful, all furniture including upholstery and case pieces can scratch, scuff and even gouge floors. The recommendation is to have felt, rubber pads or area rugs under furniture on flooring without carpet.

### **Moving your furniture**

Pushing and dragging furniture over floors without carpet can lead to scratches and scuffs. Have someone help when moving the larger pieces of furniture by lifting, try using a dolly or moving pads.

### **Felt and rubber pads**

Applying furniture pads to the feet of furniture helps cushion contact points. Furniture pads can be found at local hardware stores. Felt pads slide easily across the floor, making them ideal for dining chairs and other pieces that move with use. Rubber pads will help furniture stay in place and are perfect for larger pieces, like sofas and loveseats.

### **Area rugs and rug pads**

Using an area rug under furniture is another way to protect your floor from scratches and scuff marks. A rug pad under the area rug will provide extra cushion and added protection.