



PARTS LIST / LISTE DES PIÈCES / LISTA DE PIEZAS

ITEM NO. / ARTICLE NO. / ARTICULO NO. : 21001

DESCRIPTION / DESCRIPCIÓN : CONER CURIO / CUIRO EN COIN / VITRINA DE ESQUINA

**WARNING**

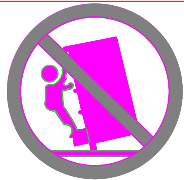

**Serious or fatal crushing injuries can occur from furniture tip-over. To help prevent tip-over:**

- install tipover restraint provided.
- Place heaviest items in the lowest drawers.
- Do not set TV's or other heavy objects on top of this product unless the product is specifically designed to accommodate them.
- Never allow children to climb or hang on drawers, doors, or shelves.
- Never open more than one drawers at a time (OR)
- Do not defeat or remove the drawers interlock system.

**Use of tip-over restraints may only reduce, but not eliminate, the risk of tip-over. this is a permanent label. Do not remove!**

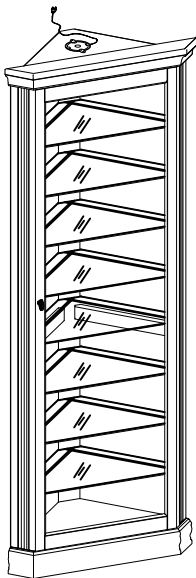
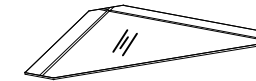
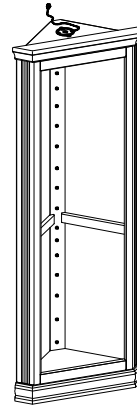

**A**

- x1 Corner Curio
- x1 Curio en coin
- x1 Vitrina de esquina

**B**

- x8 Glass shelf \*
- x8 Étagère en verre
- x8 Estante de vidrio

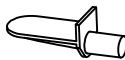

**C**

- x16 Common Shelf Support Flat \*
- x16 Supports Pour Tablette
- x16 Soporte De Las Repisas



**D**

- x8 Common Shelf Support Slot \*
- x8 Supports Pour Tablette
- x8 Soporte De Las Repisas

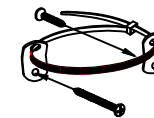

**E**

- x1 Furniture Tipping Restraint
- x1 Systeme antibasculement
- x1 Control para evitar vulcos

\* Replaceable Part

**WARNING**

Serious or fatal crushing injuries can occur from furniture tip-over. To help prevent tip-over:

- install tipover restraint provided.
- Place heaviest items in the lowest drawers.
- Do not set TV's or other heavy objects on top of this product unless the product is specifically designed to accommodate them.
- Never allow children to climb or hang on drawers, doors, or shelves.
- Never open more than one drawers at a time (OR)
- Do not defeat or remove the drawers interlock system.

Use of tip-over restraints may only reduce, but not eliminate, the risk of tip-over. this is a permanent label. Do not remove!

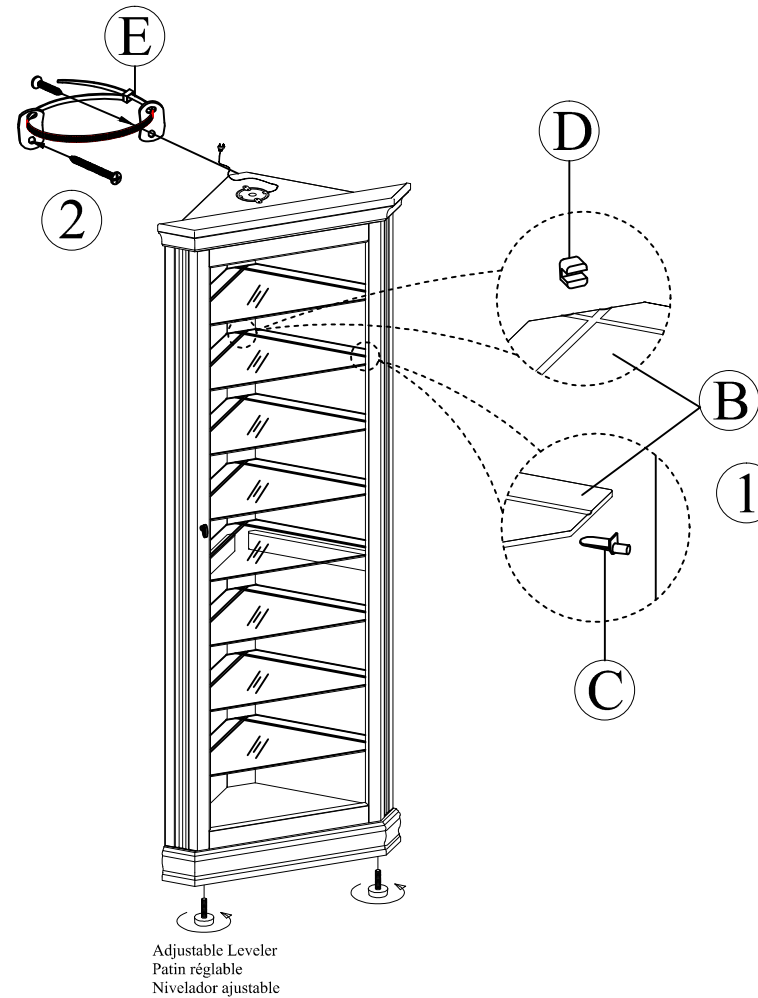
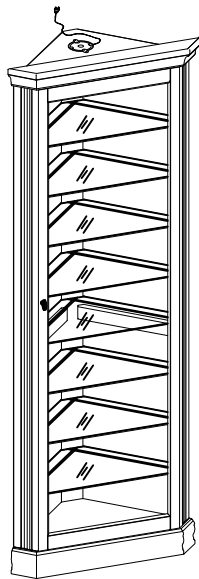
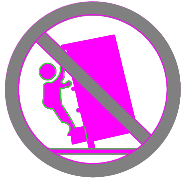



REPLACEABLE PART / PARTIE REMPLACABLE / PARTE REEMPLAZABLE  
 ITEM NO. / ARTICLE NO. / ARTICULO NO. : 21001  
 DESCRIPTION / DESCRIPCIÓN : CONER CURIÓ / CUIRO EN COIN / VITRINA DE ESQUINA

**WARNING**

Serious or fatal crushing injuries can occur from furniture tip-over. To help prevent tip-over:

- install tipover restraint provided.
- Place heaviest items in the lowest drawers.
- Do not set TV's or other heavy objects on top of this product unless the product is specifically designed to accommodate them.
- Never allow children to climb or hang on drawers, doors, or shelves.
- Never open more than one drawers at a time (OR)
- Do not defeat or remove the drawers interlock system.

Use of tip-over restraints may only reduce, but not eliminate, the risk of tip-over. this is a permanent label. Do not remove!

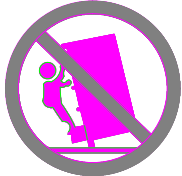

x1 R005431-40  
 Door Pull \*  
 Poignée  
 Tirador

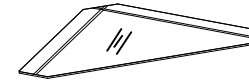

x8 R01123-60  
 Glass shelf \*  
 Étagère en verre  
 Estante de vidrio

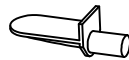
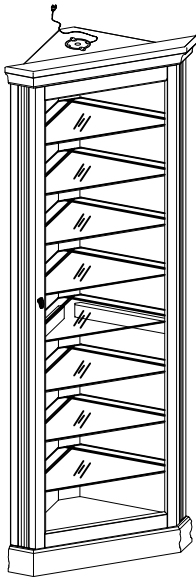

x16 RC-SUPPORT-03  
 Common Shelf Support Flat \*  
 Supports Pour Tablette  
 Soporte De Las Repisas



x8 RC-SUPPORT-04  
 Common Shelf Support Slot \*  
 Supports Pour Tablette  
 Soporte De Las Repisas

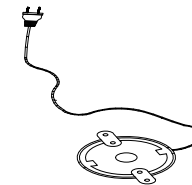

x1 RC-LIGHT-01  
 Light fixture w/roll switch \*  
 lumière et interrupteur  
 luz y interruptor

\* Replaceable Part