

## PARTS LIST / LISTE DES PIÈCES / LISTA DE PIEZA

ITEM / NO D'ARTICLE / ARTICULO.: S964-146

Description/ La Description / Descripción : Server / Serveuse / Servidora

	<p><b>WARNING</b></p> <p>Children have died from furniture tipover. To reduce the risk of furniture tipover:</p> <ul style="list-style-type: none"> <li>- ALWAYS install anti-tip device provided.</li> <li>- NEVER put a TV on this product.</li> <li>- NEVER allow children to stand, climb, or hang on any drawers, doors, or shelves.</li> <li>- NEVER open more than one drawer at a time.</li> <li>- Place heaviest items in the lowest drawers.</li> </ul> <p><i>This is a permanent label. Do not remove!</i></p>
	

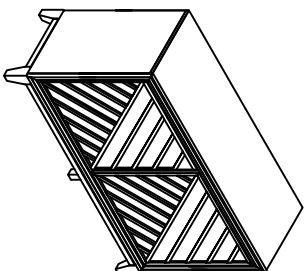
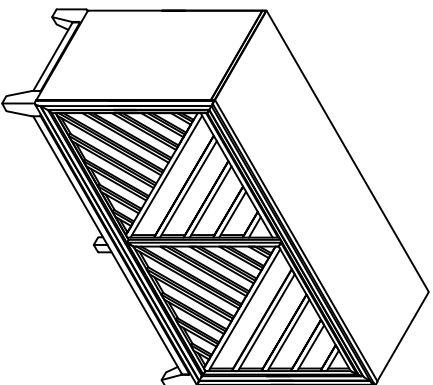

**A**

x1 Server  
x1 Serveuse  
x1 Servidora



**B**

x1 Furniture Tipping Restraint  
x1 Système antibasculement  
x1 Control para evitar vuelcos

\*

\* Replaceable Part

## ASSEMBLY INSTRUCTION / NOTICE DE MONTAGE / INSTRUCCIONES DE MONTAJE

ITEM / NO D'ARTICLE / ARTICULO.: S964-146

Description/ La Description / Descripción : Server / Serveuse / Servidora

	<p><b>⚠ WARNING</b></p> <p>Children have died from furniture tipover. To reduce the risk of furniture tipover:</p> <ul style="list-style-type: none"> <li>- ALWAYS install anti-tip device provided.</li> <li>- NEVER put a TV on this product.</li> <li>- NEVER allow children to stand, climb, or hang on any drawers, doors, or shelves.</li> <li>- NEVER open more than one drawer at a time.</li> <li>- Place heaviest items in the lowest drawers.</li> </ul> <p><i>This is a permanent label. Do not remove!</i></p>
	

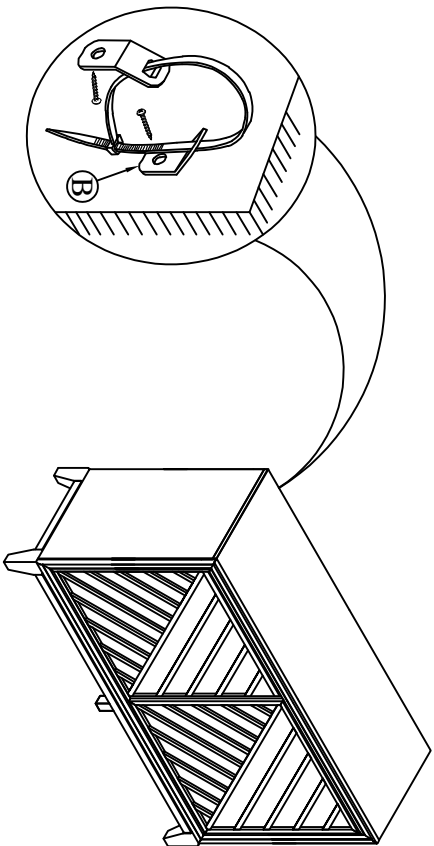

Furniture Tipping Restraint  
Système antibasculement  
Control para evitar vuelcos

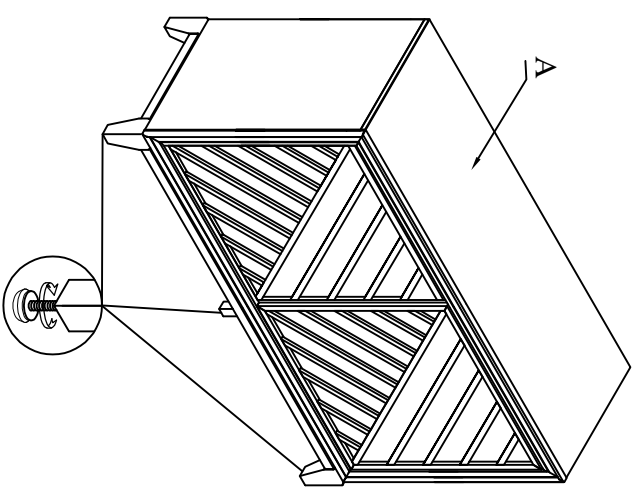

Adjustable leveler  
Patin réglable  
Nivelador ajustable

\*Replaceable Part

## REPLACEABLE PART / PARTIE REMPLACABLE / PARTE REEMPLAZABLE

ITEM / NO D'ARTICLE / ARTICULO.: S964-146

Description/ La Description / Descripción : Server / Serveuse / Servidora

	<p><b>WARNING</b></p> <p>Children have died from furniture tipover. To reduce the risk of furniture tipover:</p> <ul style="list-style-type: none"> <li>- ALWAYS install anti-tip device provided.</li> <li>- NEVER put a TV on this product.</li> <li>- NEVER allow children to stand, climb, or hang on any drawers, doors, or shelves.</li> <li>- NEVER open more than one drawer at a time.</li> <li>- Place heaviest items in the lowest drawers.</li> </ul> <p><i>This is a permanent label! Do not remove!</i></p>
	

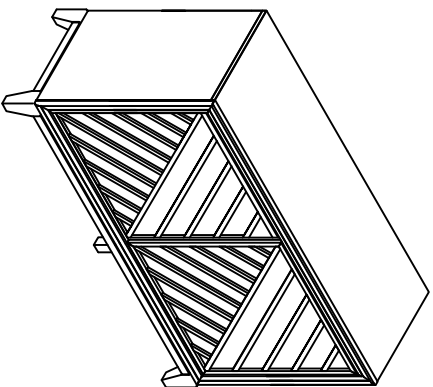

x2 RC-BR-NAL- Brown Plastic nail  
clou en plastique  
clavo de plastico

\*

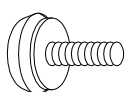

x3 RC-FG-BROWN-Brown leveler  
Niveladora marron  
Niveleur marron

\*



x1 RC-ANTI-TIP-Furniture Tipping Restraint  
Système antibasculement  
Control para evitar vuelcos

\*



x16 RS964-010-PIN-Shelf pin  
Épingle  
Estantería

\*

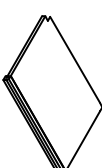

x2 RS964-146-SHELLFL-Left Wood shelf  
Étagère en bois gauche  
Estante de madera izquierda(g)

\*

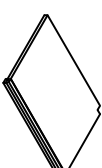

x2 RS964-146-SHELLFR-Right Wood shelf  
Étagère en bois droite  
Estante de madera derecho

\*



x1 RS964-010-CE-Center Support Leg  
Jambe de support centrale  
Pata de apoyo central

\*

**\* Replaceable Part**

## **Protect Your Wood or Laminate Flooring**

\*This statement applies to any floor without carpet.

If not careful, all furniture including upholstery and case pieces can scratch, scuff and even gouge floors. The recommendation is to have felt, rubber pads or area rugs under furniture on flooring without carpet.

### **Moving your furniture**

Pushing and dragging furniture over floors without carpet can lead to scratches and scuffs. Have someone help when moving the larger pieces of furniture by lifting, try using a dolly or moving pads.

### **Felt and rubber pads**

Applying furniture pads to the feet of furniture helps cushion contact points. Furniture pads can be found at local hardware stores. Felt pads slide easily across the floor, making them ideal for dining chairs and other pieces that move with use. Rubber pads will help furniture stay in place and are perfect for larger pieces, like sofas and loveseats.

### **Area rugs and rug pads**

Using an area rug under furniture is another way to protect your floor from scratches and scuff marks. A rug pad under the area rug will provide extra cushion and added protection.