

PARTS LIST / LISTE DES PIÈCES / LISTA DE PIEZAS

ITEM NO. / ARTICLE NO. / ARTICULO NO. : 20671

DESCRIPTION / DESCRIPCIÓN : CONER CURIO / CUIRO EN COIN / VITRINA DE ESQUINA

WARNING



Serious or fatal crushing injuries can occur from furniture tip-over. To help prevent tip-over:

- install tipover restraint provided.
- Place heaviest items in the lowest drawers.
- Do not set TV's or other heavy objects on top of this product unless the product is specifically designed to accommodate them.
- Never allow children to climb or hang on drawers, doors, or shelves.
- Never open more than one drawers at a time (OR)
- Do not defeat or remove the drawers interlock system.

Use of tip-over restraints may only reduce, but not eliminate, the risk of tip-over. this is a permanent label. Do not remove!

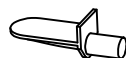
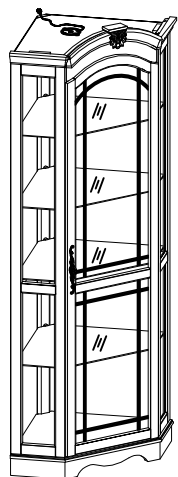
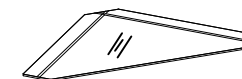
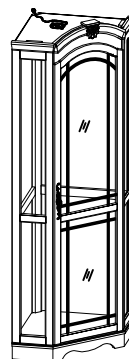

C

x8 Common Shelf Support Flat*
x8 Supports Pour Tablette
x8 Soporte De Las Repisas

A

x1 Corner Curio
x1 Curio en coin
x1 Vitrina de esquina



D

x4 Common Shelf Support Slot*
x4 Supports Pour Tablette
x4 Soporte De Las Repisas

B

x4 Glass shelf*
x4 Étagère en verre
x4 Estante de vidrio



E

x1 Furniture Tipping Restraint
x1 Systeme antibasculment
x1 Control para evitar vulcos

* Replaceable Part

ASSEMBLY INSTRUCTIONS / NOTICE DE MONTAGE / INSTRUCCIONES DE MONTAJE
ITEM NO. / ARTICLE NO. / ARTICULO NO. : 20671

DESCRIPTION / DESCRIPCIÓN : CONER CURIO / CUIRO EN COIN / VITRINA DE ESQUINA

▲ WARNING

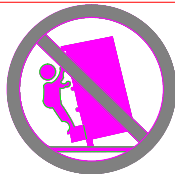

Serious or fatal crushing injuries can occur from furniture tip-over. To help prevent tip-over:

- install tipover restraint provided.
- Place heaviest items in the lowest drawers.
- Do not set TV's or other heavy objects on top of this product unless the product is specifically designed to accommodate them.
- Never allow children to climb or hang on drawers, doors, or shelves.
- Never open more than one drawers at a time (OR)
- Do not defeat or remove the drawers interlock system.

Use of tip-over restraints may only reduce, but not eliminate, the risk of tip-over. this is a permanent label. Do not remove!

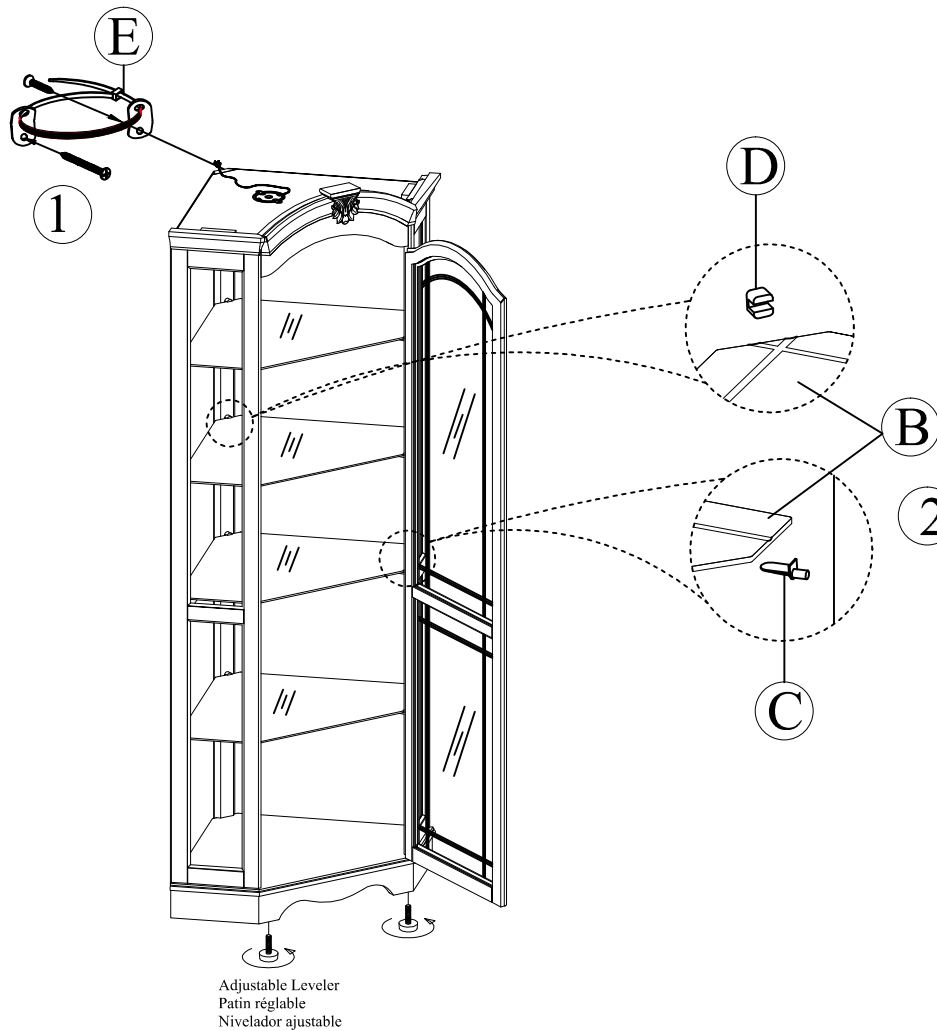
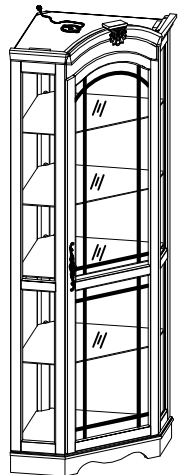



REPLACEABLE PART / PARTIE REMPLACABLE / PARTE REEMPLAZABLE

ITEM NO. / ARTICLE NO. / ARTICULO NO. : 20671

DESCRIPTION / DESCRIPCIÓN : CONER CURIO / CUIRO EN COIN / VITRINA DE ESQUINA

WARNING

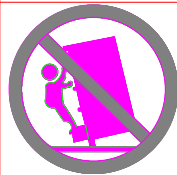

Serious or fatal crushing injuries can occur from furniture tip-over. To help prevent tip-over:

- install tipover restraint provided.
- Place heaviest items in the lowest drawers.
- Do not set TV's or other heavy objects on top of this product unless the product is specifically designed to accommodate them.
- Never allow children to climb or hang on drawers, doors, or shelves.
- Never open more than one drawers at a time (OR)
- Do not defeat or remove the drawers interlock system.

Use of tip-over restraints may only reduce, but not eliminate, the risk of tip-over. this is a permanent label. Do not remove!



x1 R142036-40
Pull key and back plate*
Tirer et Plaque
Tire y Placa

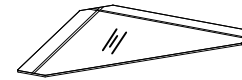

x4 R01071-60
Glass shelf*
Étagère en verre
Estante de vidrio



x3 R20671-CATCH
Door catch*
Catch de aimant
Captura de imán

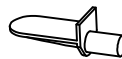
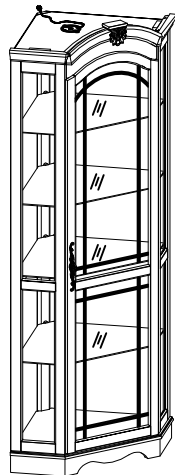

x8 RC-SUPPORT-03
Common Shelf Support Flat*
Supports Pour Tablette
Soporte De Las Repisas



x4 RC-SUPPORT-04
Common Shelf Support Slot*
Supports Pour Tablette
Soporte De Las Repisas

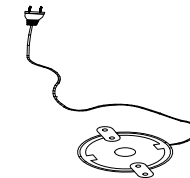

x1 RC-LIGHT-01
Light fixture w/roll switch*
lumière et interrupteur
luz y interruptor

* Replaceable Part