

PARTS LIST / LISTE DES PIÈCES / LISTA DE PIEZA

ITEM / NO D'ARTICLE / ARTICULO.: S958-042

Description/ La Description / Descripción : Door Chest / Coffre de portes / Cofre de la puerta

	<p>⚠ WARNING</p> <p>Children have died from furniture tipover. To reduce the risk of furniture tipover:</p> <ul style="list-style-type: none"> - ALWAYS install anti-tip device provided. - NEVER put a TV on this product. - NEVER allow children to stand, climb, or hang on any drawers, doors, or shelves. - NEVER open more than one drawer at a time. - Place heaviest items in the lowest drawers. <p><i>This is a permanent label. Do not remove!</i></p>
	

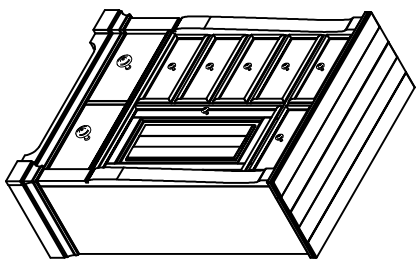
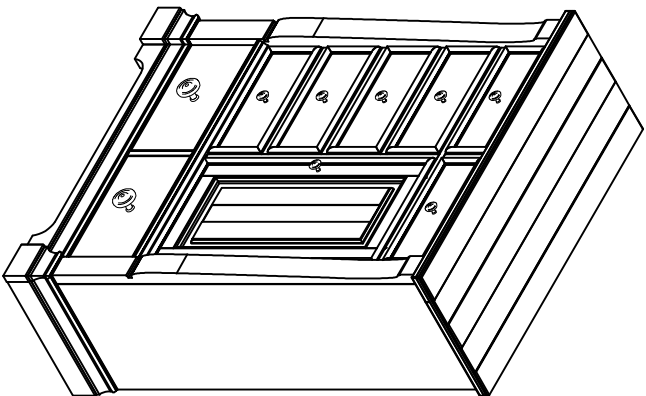

A

x1 Door Chest
x1 Coffre de portes
x1 Cofre de la puerta



B

x1 Furniture Tipping Restraint
x1 Système antipasculement
x1 Control para evitar vuelcos

*

*Replaceable Part

ASSEMBLY INSTRUCTION / NOTICE DE MONTAGE / INSTRUCCIONES DE MONTAJE

ITEM / NO D'ARTICLE / ARTICULO.: S958-042

Description/ La Description / Descripción : Door Chest / Coffre de portes / Cofre de la puerta

⚠ WARNING	
	<p>Children have died from furniture tipover. To reduce the risk of furniture tipover:</p> <ul style="list-style-type: none"> - ALWAYS install anti-tip device provided. - NEVER put a TV on this product. - NEVER allow children to stand, climb, or hang on any drawers, doors, or shelves. - NEVER open more than one drawer at a time. - Place heaviest items in the lowest drawers. <p><i>This is a permanent label. Do not remove!</i></p>
	

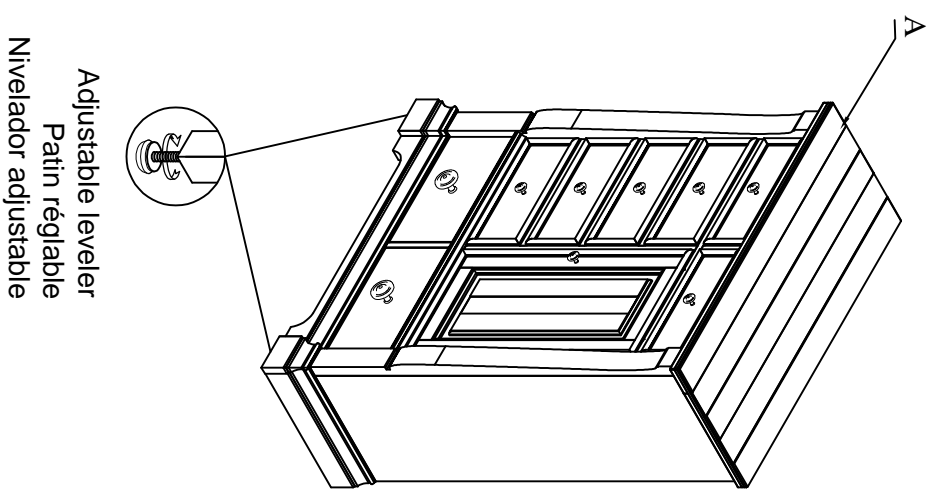
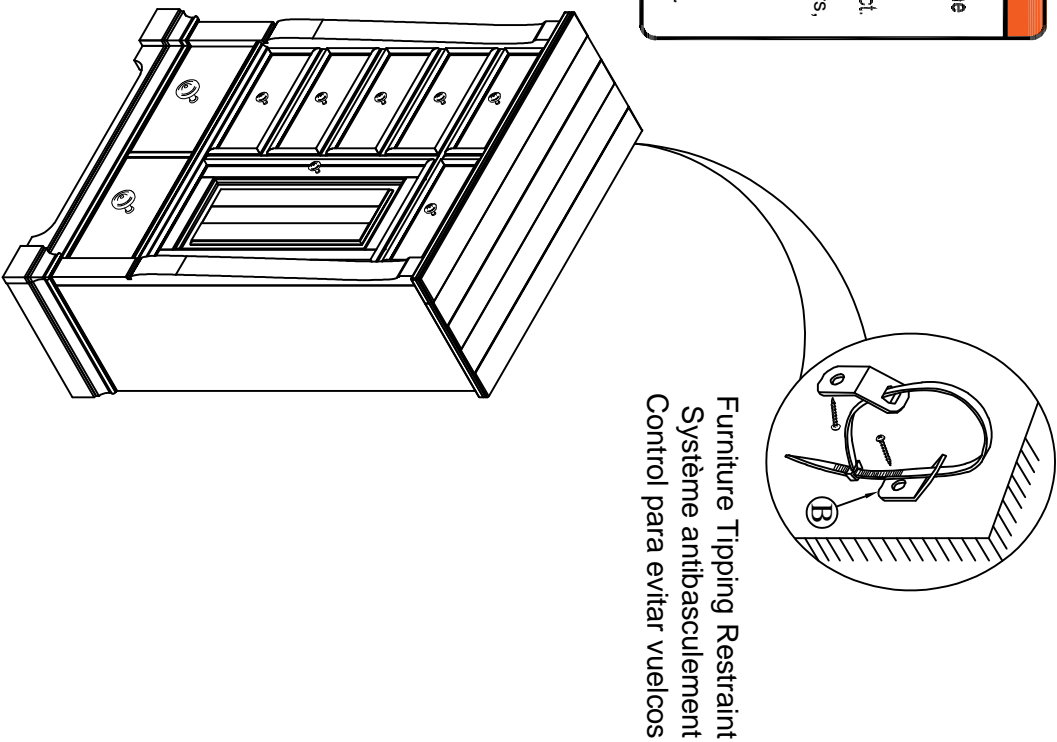

*Replaceable Part









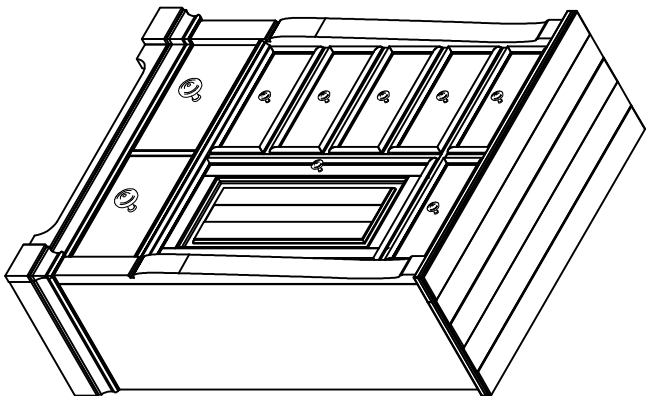

REPLACEABLE PART / PARTIE REMPLACABLE / PARTE REEMPLAZABLE

ITEM / NO D'ARTICLE / ARTICULO.: S958-042

Description/ La Description / Descripción : Door Chest / Coffre de portes / Cofre de la puerta

	⚠ WARNING
	
<p>Children have died from furniture tipover. To reduce the risk of furniture tipover:</p> <ul style="list-style-type: none"> - ALWAYS install anti-tip device provided. - NEVER put a TV on this product. - NEVER allow children to stand, climb, or hang on any drawers, doors, or shelves. - NEVER open more than one drawer at a time. - Place heaviest items in the lowest drawers. <p><i>This is a permanent label. Do not remove!</i></p>	

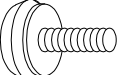

	*		*		*
x2 RS958-010-KNOBB-Big Knob with Screw Poignée + Vis Tirador + Tornillo		x8 COMGLIDE-10-45 - Drawer Glide Glisnière de tiroir Deslizamiento del cajón		x1 RC-ANTI-TIP-Furniture Tipping Restraint Système antibasculement Control para evitar vuelcos	
	*		*		*
x7 RS958-010-KNOBS-Small Knob with Screw Poignée + Vis Tirador + Tornillo		x1 RS958-041-CATCH-Magnetic Catch Loquet magnétique Captura magnética		x2 RS958-041-HINGE-Door Hinge Bisagra de la puerta Charnière de porte	
	*		*		*
x2 RS958-042-SHELF-Wood Shelf Étagère en bois droite Estante de madera derecho		x2 RC-BR-NAIL - Brown Plastic nail clou en plastique clavo de plástico		x2 RC-FG-BROWN-Brown leveler Niveladora marrón Niveleur marron	
	*				
x8 RS958-041-PIN-Sheff pin Épingle Estantería					

* Replaceable Part

Protect Your Wood or Laminate Flooring

*This statement applies to any floor without carpet.

If not careful, all furniture including upholstery and case pieces can scratch, scuff and even gouge floors. The recommendation is to have felt, rubber pads or area rugs under furniture on flooring without carpet.

Moving your furniture

Pushing and dragging furniture over floors without carpet can lead to scratches and scuffs. Have someone help when moving the larger pieces of furniture by lifting, try using a dolly or moving pads.

Felt and rubber pads

Applying furniture pads to the feet of furniture helps cushion contact points. Furniture pads can be found at local hardware stores. Felt pads slide easily across the floor, making them ideal for dining chairs and other pieces that move with use. Rubber pads will help furniture stay in place and are perfect for larger pieces, like sofas and loveseats.

Area rugs and rug pads

Using an area rug under furniture is another way to protect your floor from scratches and scuff marks. A rug pad under the area rug will provide extra cushion and added protection.