

PARTS LIST / LISTE DES PIÈCES / LISTA DE PIEZA

ITEM / NO D'ARTICLE / ARTICULO.: S964-010/030

Description/ La Description / Descripción: Dresser / Commode / Tocado

Beveled Mirror / Miroir / Espejo

| | |
|---|---|
|  | <p>WARNING</p> <p>Children have died from furniture tipover. To reduce the risk of furniture tipover:</p> <ul style="list-style-type: none"> - ALWAYS install anti-tip device provided. - NEVER put a TV on this product. - NEVER allow children to stand, climb, or hang on any drawers, doors, or shelves. - NEVER open more than one drawer at a time. - Place heaviest items in the lowest drawers. <p><i>This is a permanent label! Do not remove!</i></p> |
|  | |

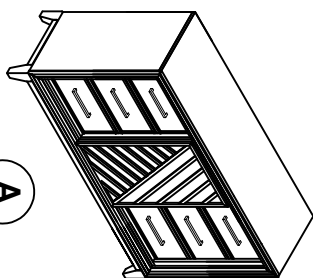

A

- x1 Dresser
- x1 Commode
- x1 Tocado

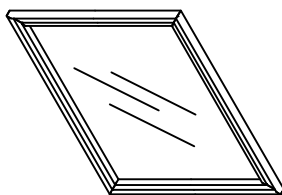

B

- x1 Mirror
- x1 Miroir
- x1 Espejo

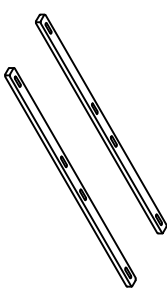

C

- x2 Mirror Support *
- x2 Prise en charge du miroir
- x2 Soporte de espejo



D

- x1 Furniture Tripping Restraint *
- x1 Système antibasculement
- x1 Control para evitar vuelcos



1

- x8 Allen bolt Ø1/4"×30mm *
- x8 Vis à tête creuse hexagonale Ø1/4"×30mm
- x8 Perno Allen Ø1/4"×30mm

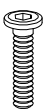

2

- x8 Lock washer Ø1/4"×13×1.5mm *
- x8 Rondelle de blocage Ø1/4"×13×1.5mm
- x8 Arandela de Seguridad Ø1/4"×13×1.5mm



3

- x8 Flat Washer Ø1/4"×19×1.5mm *
- x8 Rondelle Plate Ø1/4"×19×1.5mm
- x8 Arandela Plana Ø1/4"×19×1.5mm



4

- x1 Allen key M4 *
- x1 Clé hexagonale
- x1 Llave Allen

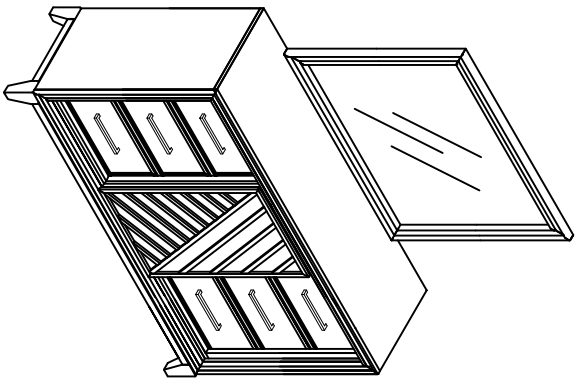

* Replaceable Part

ASSEMBLY INSTRUCTION / NOTICE DE MONTAGE / INSTRUCCIONES DE MONTAJE

ITEM / NO D'ARTICLE / ARTICULO.: S964-010/030

Description/ La Description / Descripción: Dresser / Comode / Tocado

Beveled Mirror / Miroir / Espejo

| | |
|---|---|
|  | <p>⚠ WARNING</p> <p>Children have died from furniture tipover. To reduce the risk of furniture tipover:</p> <ul style="list-style-type: none"> - ALWAYS install anti-tip device provided. - NEVER put a TV on this product. - NEVER allow children to stand, climb, or hang on any drawers, doors, or shelves. - NEVER open more than one drawer at a time. - Place heaviest items in the lowest drawers. <p><i>This is a permanent label! Do not remove!</i></p> |
|  | |

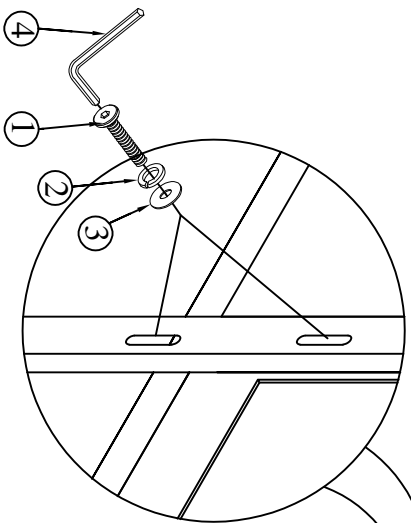

STEP 1
ÉTAPE 1
PASO 1

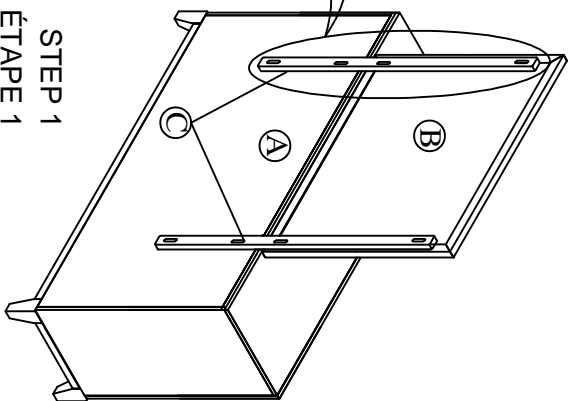

STEP 2
ÉTAPE 2
PASO 2

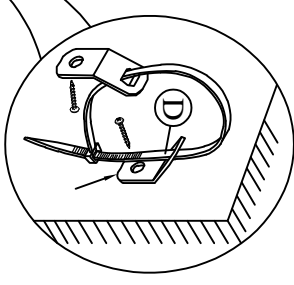

Furniture Tipping Restraint
Système antibasculement
Control para evitar vuelcos

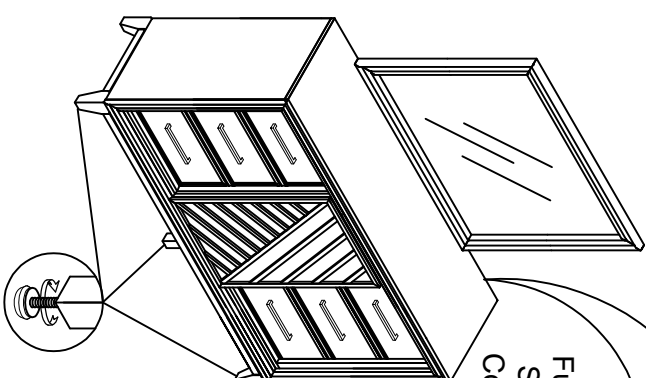

Adjustable leveler
Patin réglable
Nivelador ajustable

* Replaceable Part

REPLACEABLE PART / PARTIE REMPLACABLE / PARTE REEMPLAZABLE

ITEM / NO D'ARTICLE / ARTICULO.: S964-010/030

Description/ La Description /Descripción: Dresser / Comode / Tocador

Beveled Mirror / Miroir / Espejo

▲ **WARNING**





Children have died from furniture tipover. To reduce the risk of furniture tipover:
 - ALWAYS install anti-tip device provided.
 - NEVER put a TV on this product.
 - NEVER allow children to stand, climb, or hang on any drawers, doors, or shelves.
 - NEVER open more than one drawer at a time.
 - Place heaviest items in the lowest drawers.
This is a permanent label! Do not remove!

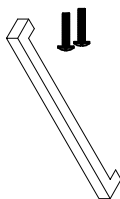
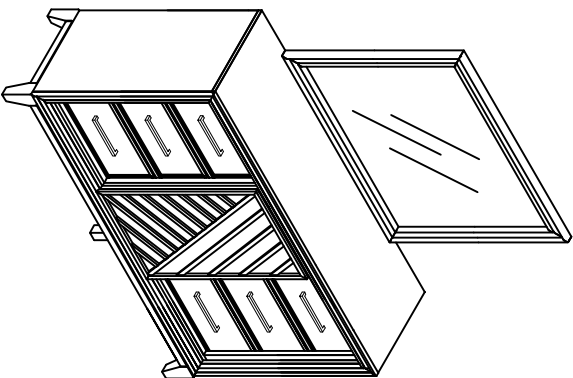

x6 RS964-010-PULL-Pull + with Screw
Tirer + Vis
Tire + Tornillo *



x2 RS964-030-MISU- Mirror Support
Supporte de miroir
Soporte del espejo *



x1 RS964-030-HWKT-Hardware kit list
Liste des pièces de quincaillies
Lista del kit de materiales *

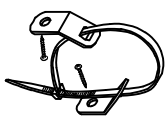

x1 RC-ANTI-TIP-Furniture Tipping Restraint
Système antibasculement
Control para evitar vuelcos *



x6 COMGLIDE-10-45 - Drawer Glide
Glissière de tiroir
Deslizamiento del cajón *

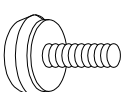

x3 RC-F-G-BROWN-Brown leveler
Niveladora marron
Niveleur marron *



x2 RC-BR-NAIL- Brown Plastic nail
clou en plastique
clavo de plástico *



x4 RS964-010-PIN-Shelf pin
Epingle
Estantería *

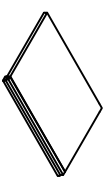

x1 RS964-010-SHELF-Wood shelf
Étagère
Estame *



x1 RS964-010-CE-Center Support Leg
Jambe de support centrale
Pata de apoyo central *

*** Replaceable Part**

Protect Your Wood or Laminate Flooring

*This statement applies to any floor without carpet.

If not careful, all furniture including upholstery and case pieces can scratch, scuff and even gouge floors. The recommendation is to have felt, rubber pads or area rugs under furniture on flooring without carpet.

Moving your furniture

Pushing and dragging furniture over floors without carpet can lead to scratches and scuffs. Have someone help when moving the larger pieces of furniture by lifting, try using a dolly or moving pads.

Felt and rubber pads

Applying furniture pads to the feet of furniture helps cushion contact points. Furniture pads can be found at local hardware stores. Felt pads slide easily across the floor, making them ideal for dining chairs and other pieces that move with use. Rubber pads will help furniture stay in place and are perfect for larger pieces, like sofas and loveseats.

Area rugs and rug pads

Using an area rug under furniture is another way to protect your floor from scratches and scuff marks. A rug pad under the area rug will provide extra cushion and added protection.