

**A**  
x1 Headboard  
x1 Tête de lit  
x1 Cabecera

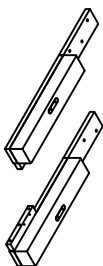

**B**  
x2 Headboard Legs (Left & Right) \*  
x2 Pattes de la tête de lit (gauche et droite)  
x2 Patas de cabecera (izquierda y derecha)

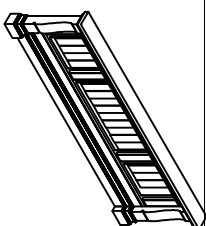

**C**  
x1 Footboard  
x1 Pied de lit  
x1 Pie de cama

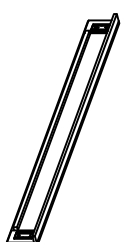

**D**  
x2 California Side Rails  
x2 Rails latéraux californiens  
x2 Rieles laterales de California



**E**  
x5 Slats \*  
x5 Lattes  
x5 Listones



**F**  
x10 Support Legs \*  
x10 Pattes de support  
x10 Patas de soporte



**1**  
x6 Allen bolt Ø5/16" \* 2" \*  
x6 Vis à tête creuse hexagonale Ø5/16" \* 2"  
x6 Perno Allen Ø5/16" \* 2"



**2**  
x14 Lock washer Ø5/16" \* 132mm \*  
x14 Rondelle de blocage Ø5/16" \* 132mm  
x14 Arandela de Seguridad Ø5/16" \* 132mm



**6**  
x1 Open wrench M12x1,90mm \*  
x1 Clé à fourche M12x1,90mm  
x1 Llave de boca M12\_L90mm



**3**  
x14 Flat washer Ø5/16" \* 192mm \*  
x14 Rondelle plate Ø5/16" \* 192mm  
x14 Arandela plana Ø5/16" \* 192mm



**4**  
x8 Hanger bolt Ø5/16" \* 3-1/2" \*  
x8 Boulon-vis Ø5/16" \* 3-1/2"  
x8 Perno de suspensión Ø5/16" \* 3-1/2"



**5**  
x8 Hex nut Ø5/16" x 12 x 6mm \*  
x8 Ecrou hexagonal Ø5/16" x 12 x 6mm  
x8 Tuerca hexagona Ø5/16" x 12 x 6mm



**7**  
x1 Allen key M4 \*  
x1 Clé hexagonale  
x1 Llave Allen



**8**  
x10 Wood Screw #8\*30mm \*  
x10 Vis à bois #8 \*30mm  
x10 Tornillo para madera #8\*30mm

\*Replaceable Part

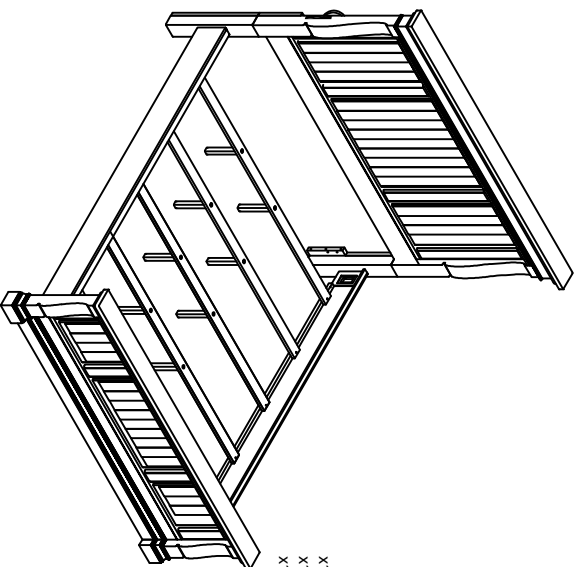

## ASSEMBLY INSTRUCTION / NOTICE DE MONTAGE / INSTRUCCIONES DE MONTAJE

ITEM / NO D'ARTICLE / ARTICULO.: S958-270/271/406

DESCRIPTION / DESCRIPCION : Headboard / Tête de lit / Cabecera

Footboard / Pied de lit / Pie de cama

Side Rails / Côtés de lit / Largueros laterales

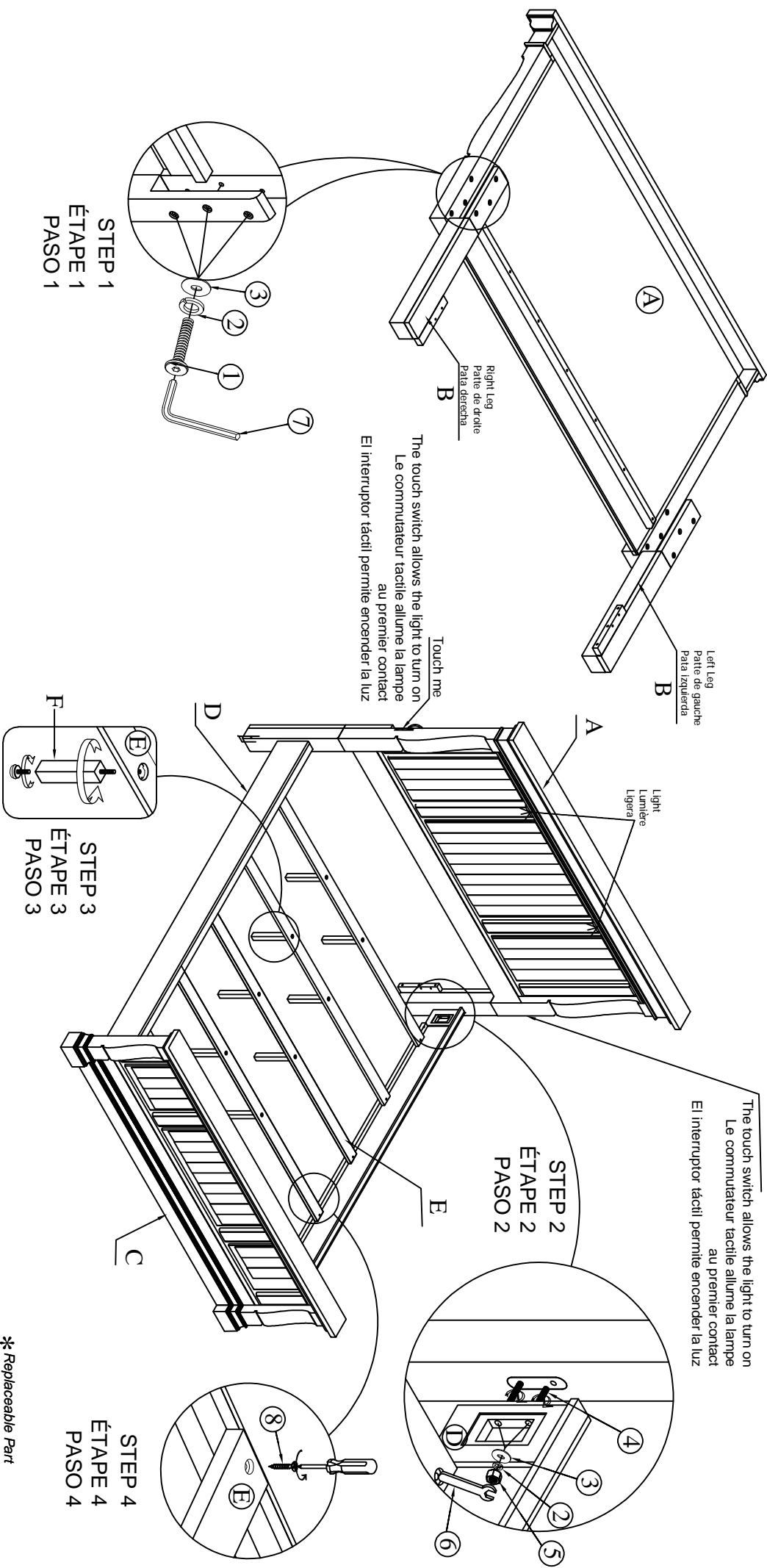

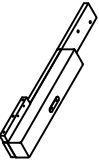

**REPLACEABLE PART / PARTIE REMPLACABLE / PARTE REEMPLAZABLE**  
**ITEM / NO D'ARTICLE / ARTICULO.: S958-270/271/406**  
**DESCRIPTION / DESCRIPCION : Headboard / Tête de lit / Cabecera**  
**Footboard / Pied de lit / Pie de cama**  
**Side Rails / Côtés de lit / Largueros laterales**

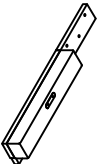
  
 x1 RS958-250-LEGR-Right Leg  
 Pattee de droite  
 Pata derecha \*

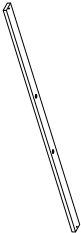
  
 x1 RS958-250-LEGL-Left Leg  
 Pattee de gauche  
 Pata izquierda \*

  
 x5 RS958-271-SLAT- Slat  
 Lattes  
 Listones \*

  
 x10 RS958-271-SULEG-Support Leg  
 Pattes de supports  
 Patas de apoyo de listones \*

  
 x1 RS958-250-HWKIT-Hardware kit list  
 Liste des pièces de quincailleries  
 Lista del kit de materiales \*

  
 x1 RS958-400-HWKIT-Hardware kit list  
 Liste des pièces de quincailleries  
 Lista del kit de materiales \*

  
 x4 RC-BR-NAIL- Brown Plastic nail  
 clou en plastique  
 clavo de plástico \*

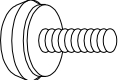
  
 x10 RC-FG-BROWN-Brown leveler  
 Niveleador marron  
 Nivelador marron \*

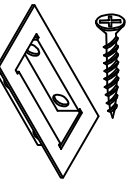
  
 x4 RS958-400-PLATE - Metal Plate  
 Plaque de métal  
 Placa de metal \*

  
 x10 RS958-251-SCREW- Screw  
 Vis  
 Tornillo \*

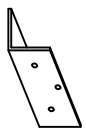
  
 x2 RS958-250-TOUCH - Touch L meta  
 Touche  
 Toque \*

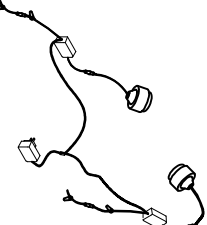
  
 x1 RS958-250-LIGHT-LIGHT SET  
 JEU DE LUMIERES  
 JUEGO DE LUCES \*

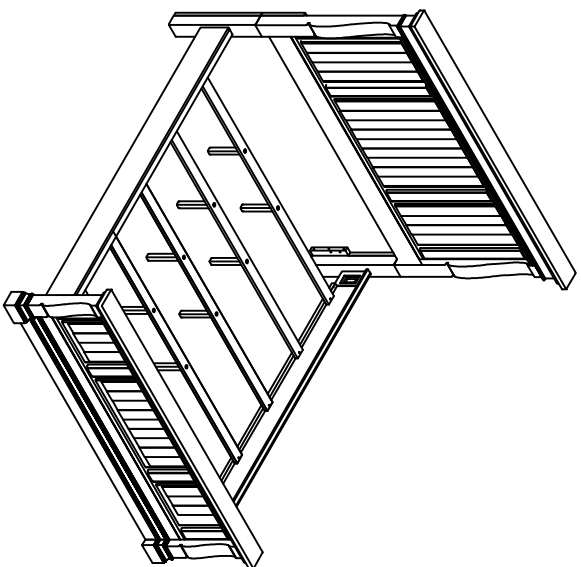

\* Replaceable Part

## **Protect Your Wood or Laminate Flooring**

\*This statement applies to any floor without carpet.

If not careful, all furniture including upholstery and case pieces can scratch, scuff and even gouge floors. The recommendation is to have felt, rubber pads or area rugs under furniture on flooring without carpet.

### **Moving your furniture**

Pushing and dragging furniture over floors without carpet can lead to scratches and scuffs. Have someone help when moving the larger pieces of furniture by lifting, try using a dolly or moving pads.

### **Felt and rubber pads**

Applying furniture pads to the feet of furniture helps cushion contact points. Furniture pads can be found at local hardware stores. Felt pads slide easily across the floor, making them ideal for dining chairs and other pieces that move with use. Rubber pads will help furniture stay in place and are perfect for larger pieces, like sofas and loveseats.

### **Area rugs and rug pads**

Using an area rug under furniture is another way to protect your floor from scratches and scuff marks. A rug pad under the area rug will provide extra cushion and added protection.