

x1 Center Leg
x1 Pattes centrales
x1 Patas centrales



x2 Back Legs
x2 jambes
x2 Piernas



x2 Front Legs
x2 jambes
x2 Piernas

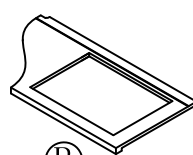

x2 Adjustable Shelf-Left
x2 Tablette ajustable
x2 Estante ajustable

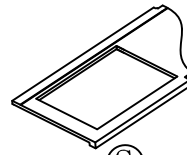

x2 Adjustable Shelf-Right
x2 Tablette ajustable
x2 Estante ajustable

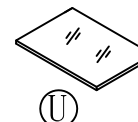

x4 Glass Shelf
x4 Étagère en verre
x4 Estante de vidrio

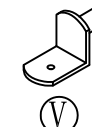

x16 Shelf Supports
x16 Supports Pour Tablette
x16 Soporte De Las Repisas

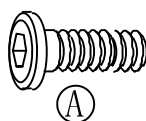

x2 Bolt 5/16*70mm
x2 Boulon
x2 Perno



x2 Lock washer 5/16 "
x2 Rondelle de blocage
x2 Arandela de Seguridad



x2 Flat Washer 5/16*16mm
x2 Rondelle plate
x2 Arandela plana

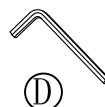

x1 Allen Wrench 7/32*29*5mm
x1 Clé hexagonale
x1 Llave Allen



x4 Flat Washer 1/4*16mm
x4 Rondelle plate
x4 Arandela plana



x4 Lock washer 1/4 "
x4 Rondelle de blocage
x4 Arandela de Seguridad

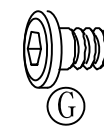

x4 Bolt 1/4*19MM
x4 Boulon
x4 Perno

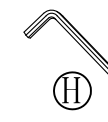

x1 Allen Wrench 6/16*27, 2*4mm
x1 Clé hexagonale
x1 Llave Allen

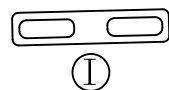

x2 Metal plate
x2 Plaque de métal
x2 Placa de metal

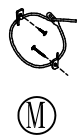

x1 Tipping restraint
x1 Liste des pièces de quincaillerie antibasculement
x1 Abrazadera antivuelco

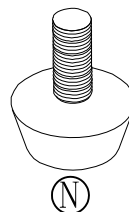

x3 Adjustable leveler-White
x3 Patin réglable
x3 Nivelador ajustable

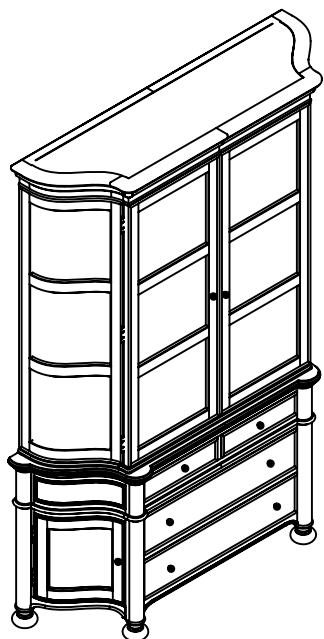

* Replaceable Part

WARNING

Children have died from furniture tipover. To reduce the risk of furniture tipover:

- ALWAYS install tipover restraint provided.
- NEVER put a TV on this product.
- NEVER allow children to stand, climb or hang on drawers, doors, or shelves.
- NEVER open more than one drawer at a time.
- Place heaviest items in the lowest drawers.

This is a permanent label. Do not remove!

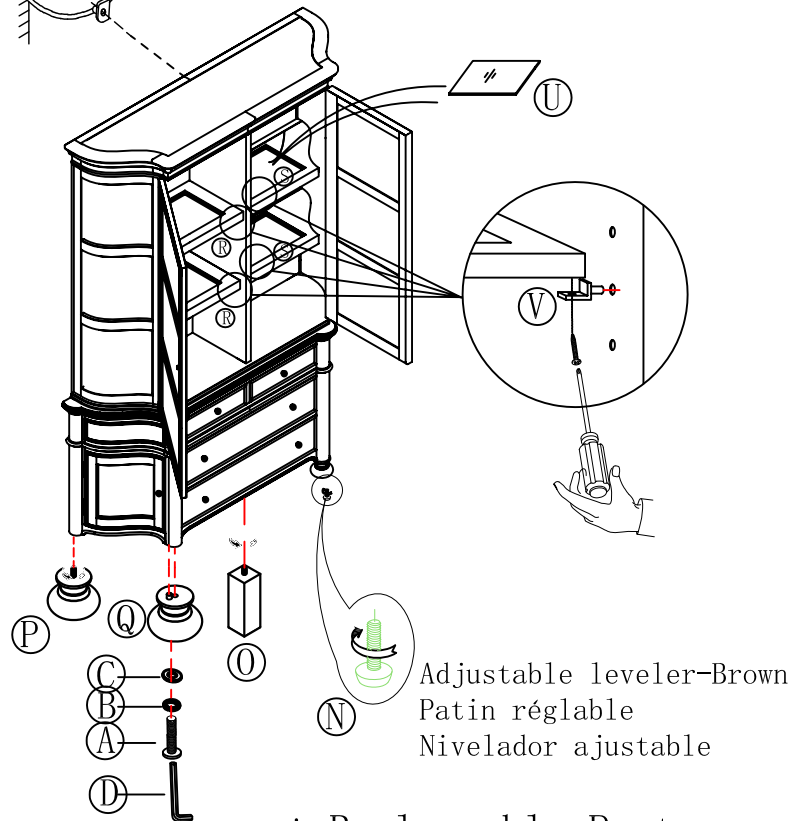
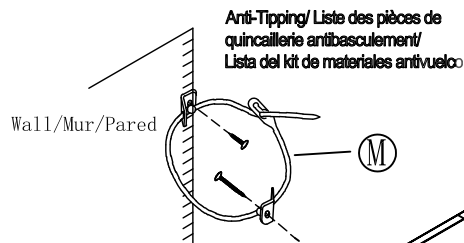
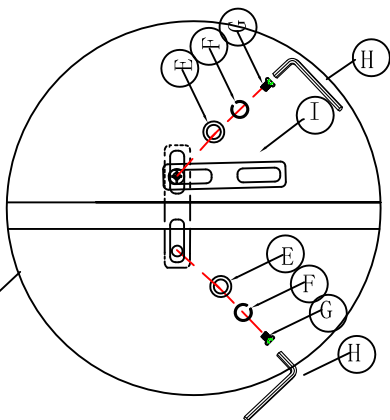
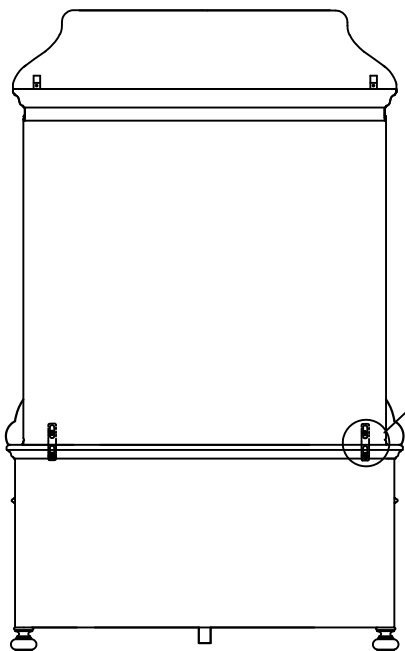

* Replaceable Part

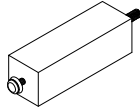

RP349305-CELEG *
x1 Center Leg
x1 Pattes centrales
x1 Patas centrales



RP349305-BLEG *
x2 Back Legs
x2 jambes
x2 Piernas



RP349305-FLEG *
x2 Front Legs
x2 jambes
x2 Piernas

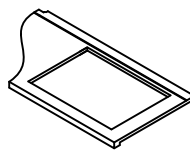

RP349305-LSHELF *
x2 Adjustable Shelf-Left
x2 Tablette ajustable
x2 Estante ajustable

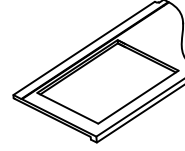

RP349305-RSHELF *
x1 Adjustable Shelf-Right top
x1 Tablette ajustable
x1 Estante ajustable

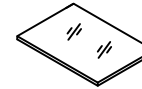

RP349305-GLASS *
x4 Glass Shelf
x4 Étagère en verre
x4 Estante de vidrio



RP349305-SUPP *
x16 Shelf Supports
x16 Supports Pour Tablette
x16 Soporte De Las Repisas

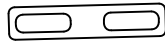
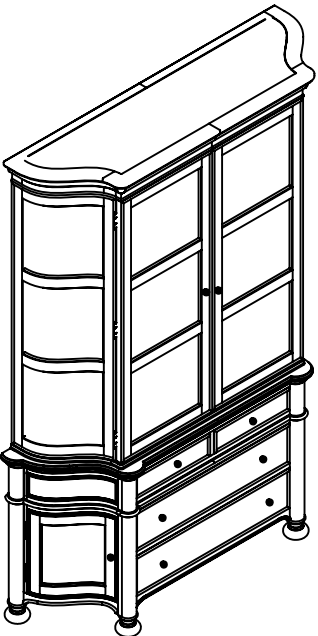

RP349305-PLATE *
x2 Metal plate
x2 Plaque de métal
x2 Placa de metal

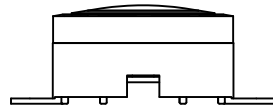

RP349305-LIGHT *
x1 Light
x1 Éclairage
x1 Iluminación

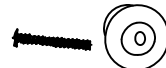

RP349100-KNOB *
x10 Knob with screw
x10 Tirer et vis
x10 Tire y Tornillo

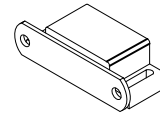

RP349305-CATCH *
x8 Door Catch
x8 Catch de aimant
x8 Captura de imá

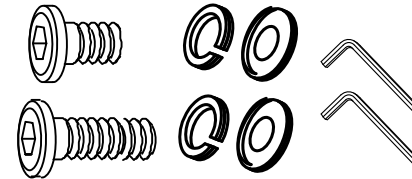

x1 RP349305-HWKIT *
Hardware Kit
Liste des pièces de quincaillerie
Lista del materiales

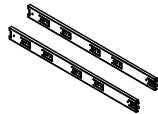

COMGLIDE-10-45 *
x4 Drawer Glide 10"Lx 45mmW
x4 Glissière
x4 Carril de deslizamiento



RC-ANTI-TIP *
x1 Tipping restraint
x1 Liste des pièces de quincaillerie antibascuement
x1 Abrazadera antivuelco

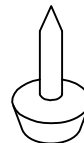

RC-WH-NAIL *
x2 Plastic Nail-White
x2 Clou en plastique
x2 Clavo de plástico

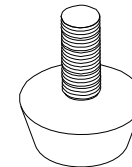

RC-FG-WHITE *
x3 Adjustable leveler-White
x3 Patin réglable
x3 Nivelador ajustable

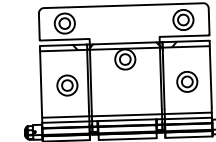

RP349305-HINGE *
x10 Door Hinge
x10 Charnière de porte
x10 Bisagra de la puerta

* Replaceable Part

Protect Your Wood or Laminate Flooring

*This statement applies to any floor without carpet.

If not careful, all furniture including upholstery and case pieces can scratch, scuff and even gouge floors. The recommendation is to have felt, rubber pads or area rugs under furniture on flooring without carpet.

Moving your furniture

Pushing and dragging furniture over floors without carpet can lead to scratches and scuffs. Have someone help when moving the larger pieces of furniture by lifting, try using a dolly or moving pads.

Felt and rubber pads

Applying furniture pads to the feet of furniture helps cushion contact points. Furniture pads can be found at local hardware stores. Felt pads slide easily across the floor, making them ideal for dining chairs and other pieces that move with use. Rubber pads will help furniture stay in place and are perfect for larger pieces, like sofas and loveseats.

Area rugs and rug pads

Using an area rug under furniture is another way to protect your floor from scratches and scuff marks. A rug pad under the area rug will provide extra cushion and added protection.