

PARTS LIST / LISTE DES PIÈCES / LISTA DE PIEZAS

ITEM NO. / NO D'ARTICLE / ARTICULO NO. : P375240/241

DESCRIPTION / LA DESCRIPTION / DESCRIPCIÓN : Double Pedestal Table Base / Base de Table de Guéridon / Base de mesa de velador
Double Pedestal Table Top / Dessus de table Guéridon / Tablero de mesa de velador

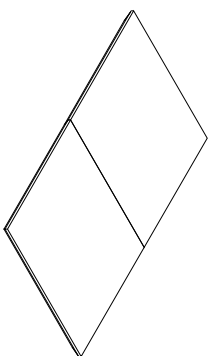
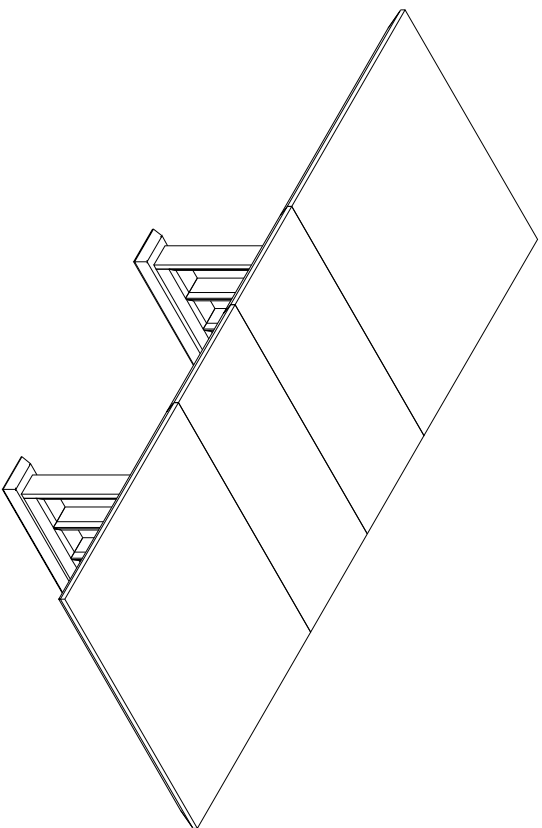

(A)

x1 Table Top
x1 Dessus de table
x1 Tablero de mesa

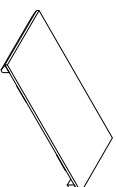

(B)

x2 Table Leaf
x2 Panneau de table
x2 Extensión

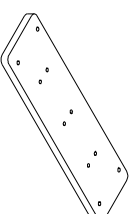

(C)

x2 Support Panel *
x2 Panneau de support
x2 Panel de soporte

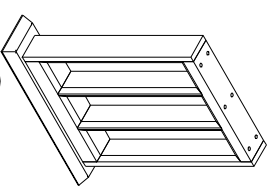

(D)

x2 Table Leg
x2 Patte de table
x2 Pata de mesa

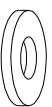

(E)

x20 Flat Washer $\phi 5/16"$ x19x2mm *
x20 Rondelle plate $\phi 5/16"$ x19x2mm
x20 Arandela plana $\phi 5/16"$ x19x2mm



(F)

x20 Lock washer $\phi 5/16"$ *
x20 Rondelle de blocage $\phi 5/16"$
x20 Arandela de Seguridad $\phi 5/16"$

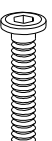

(G)

x20 Allen bolt $\phi 5/16"$ x51mm *
x20 Vis à tête creuse hexagonale $\phi 5/16"$ x51mm
x20 Perno Allen $\phi 5/16"$ x51mm

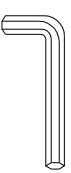

(H)

x1 Allen Key 5mm *
x1 Clé hexagonale 5mm
x1 Llave Allen 5mm

* Replaceable Part

ASSEMBLY INSTRUCTIONS/ NOTICE DE MONTAGE/ INSTRUCCIONES DE MONTAJE

ITEM NO./NO D'ARTICLE/ ARTICULO NO. : P375240/241

DESCRIPTION/ LA DESCRIPTION /DESCRIPCIÓN : Double Pedestal Table Base / Base de Table de Guéridon / Base de mesa de velador
 Double Pedestal Table Top / Dessus de table Guéridon / Tablero de mesa de velador

STEP 1
 ÉTAPE 1
 PASO 1

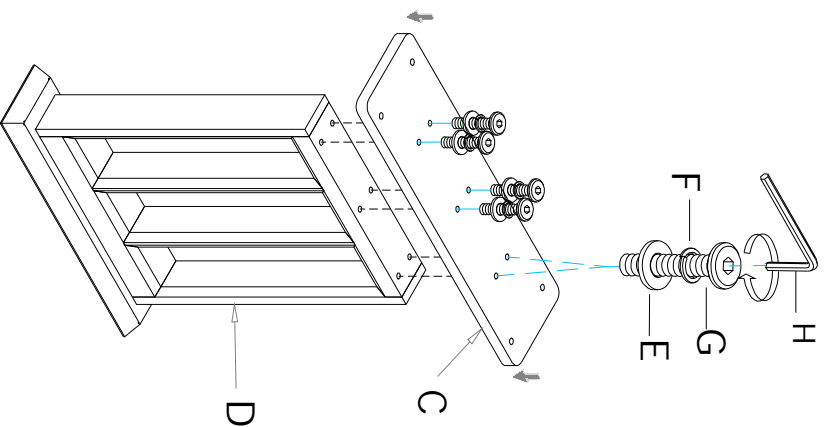

STEP 2
 ÉTAPE 2
 PASO 2

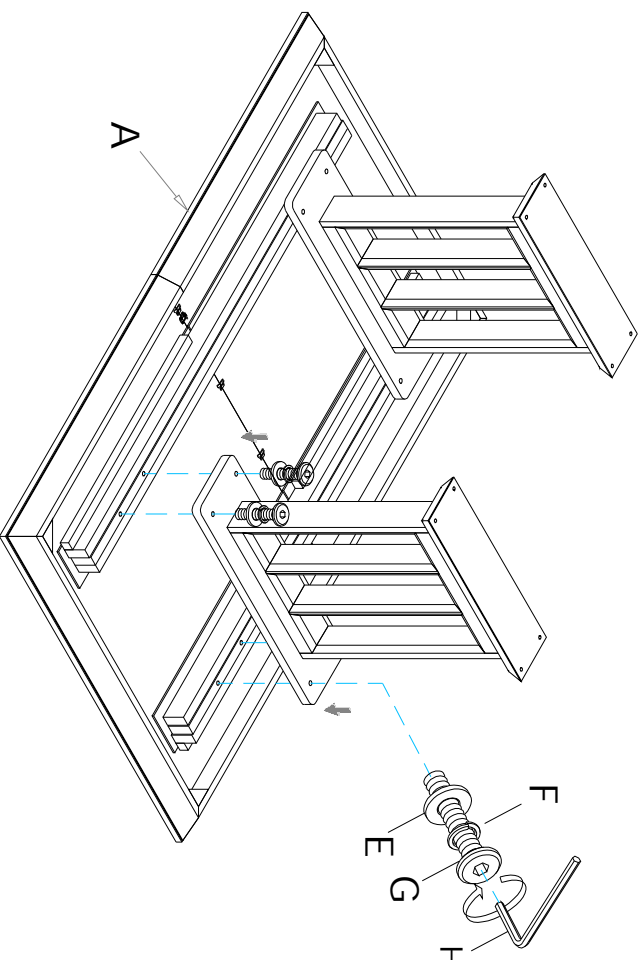

* Replaceable Part

ASSEMBLY INSTRUCTIONS/ NOTICE DE MONTAGE/ INSTRUCCIONES DE MONTAJE

ITEM NO./NO D'ARTICLE/ ARTICULO NO. :P375240/241

DESCRIPTION/ LA DESCRIPTION /DESCRIPCIÓN :Double Pedestal Table Base / Base de Table de Guéridon / Base de mesa de velador
 Double Pedestal Table Top / Dessus de table Guéridon / Tablero de mesa de velador

STEP 3 ÉTAPE 3 PASO 3

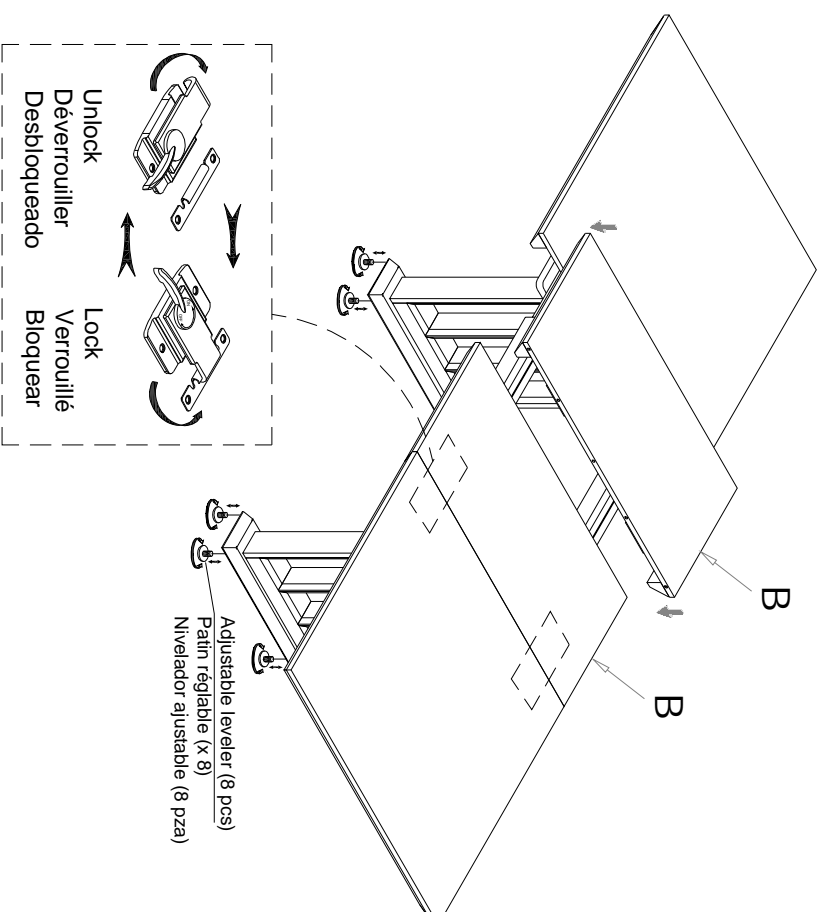
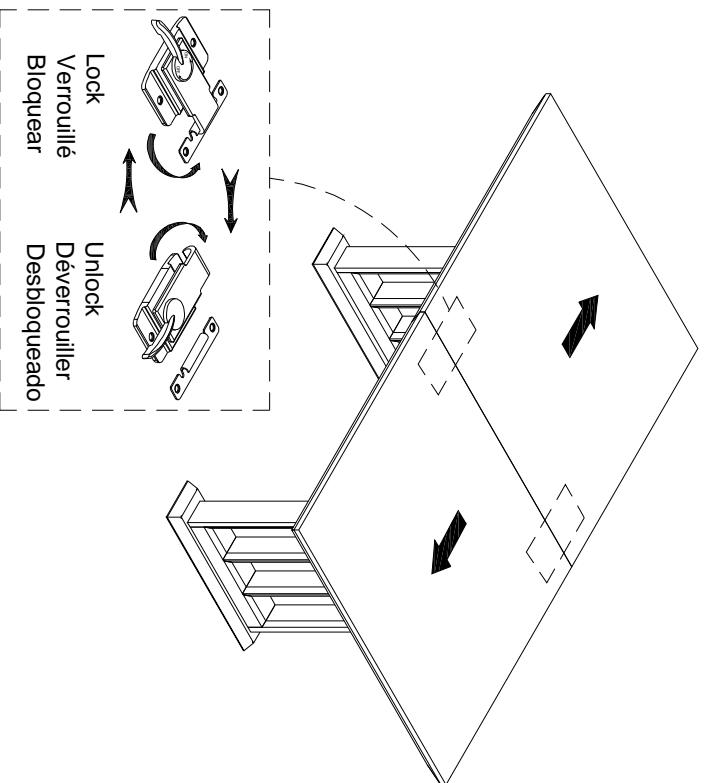

* Replaceable Part

REPLACEABLE PART / PARTIE REMPLAÇABLE / PARTE REEMPLAZABLE

ITEM NO. / NO D'ARTICLE / ARTICULO NO. : P375240/241

DESCRIPTION / LA DESCRIPTION / DESCRIPCIÓN : Double Pedestal Table Base / Base de Table de Guéridon / Base de mesa de velador
Double Pedestal Table Top / Dessus de table Guéridon / Tablero de mesa de velador

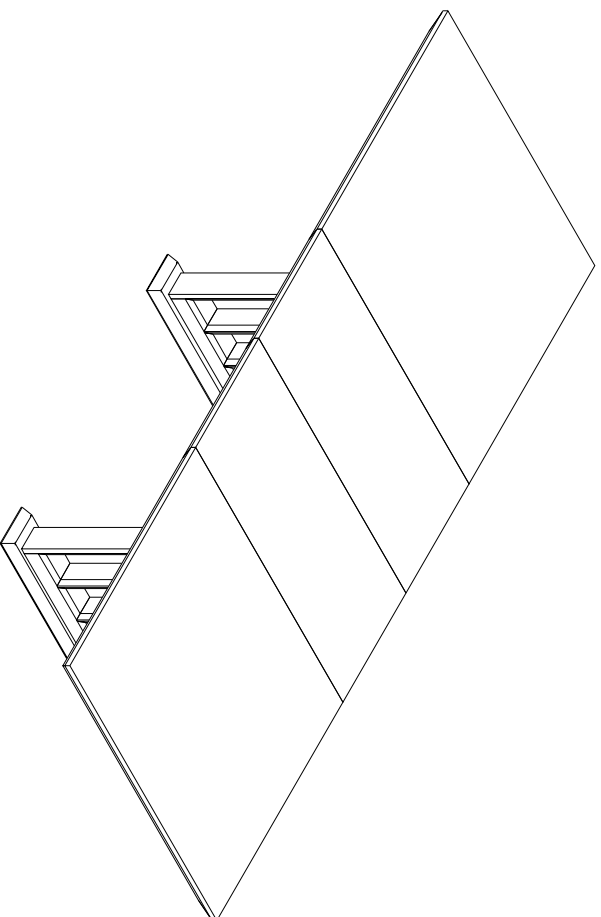

x1 RP375240-HWKIT-Hardware Kit *
Liste des pièces de quincaillerie
Lista del kit de materiales

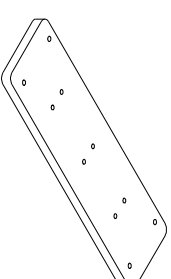

x2 RP375240-PANEL - Support panel *
Panneau de support
Panel de soporte



x8 RC-FG-WHITE Leveler *
Patín regulable
Nivelador

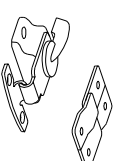

x6 RP375241-LOCK-Common SMV Table Lock *
Verrouills
Blouear

* Replaceable Part

Protect Your Wood or Laminate Flooring

* This statement applies to any floor without carpet.

If not careful, all furniture including upholstery and case pieces can scratch, scuff and even gouge floors. The recommendation is to have felt, rubber pads or area rugs under furniture on flooring without carpet.

Moving your furniture

Pushing and dragging furniture over floor without carpet can lead to scratches and scuffs. Have someone help when moving the larger pieces of furniture by lifting, try using a dolly or moving pads.

Felt and rubber pads

Applying furniture pads to the feet of furniture helps cushion contact points. Furniture pads can be found at local hardware stores. Felt pads slide easily across the floor, making them ideal for dining chairs and other pieces that move with use. Rubber pads will help furniture stay in place and are perfect for larger pieces, like sofas and loveseats.

Area rugs and rug pads

Using an are rug under furniture is another way to protect your floor from scratches and scuff marks. A rug pad under the area rug will provide extra cushion and added protection.

* *Replaceable Part*