

PARTS LIST / LISTE DES PIÈCES / LISTA DE PIEZAS

ITEM NO. / ARTICLE NO. / ARTICULO NO : S462-440

DESCRIPTION / DESCRIPCIÓN : CHEST / COMMODE / CÓMODA

WARNING



Children have died from furniture tipover. To reduce the risk of furniture tipover:

- ALWAYS install tipover restraint provided.
- NEVER put a TV on this product.
- NEVER allow children to stand, climb or hang on drawers, doors, or shelves.
- NEVER open more than one drawer at a time.
- Place heaviest items in the lowest drawers.

This is a permanent label. Do not remove!

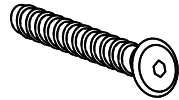
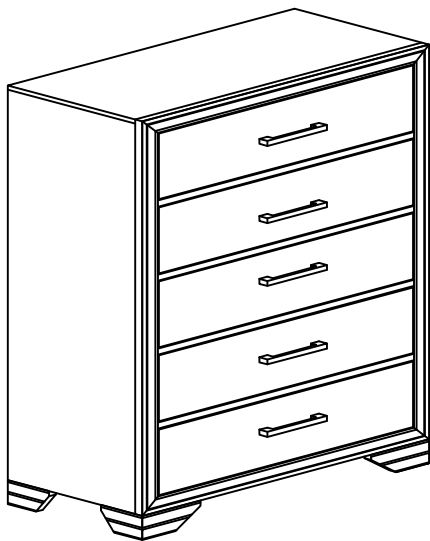

A

x8 JCBC Bolt M6 x 40MM *
x8 Boulon JCBC M6 x 40MM
x8 JCBC Perno M6 x 40MM



B

x8 Spring Washer M6 *
x8 Rondelle à ressort M6
x8 Arandela auto-bloqueante M6

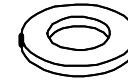

C

x8 Flat Washer M6 *
x8 Rondelle Plate M6
x8 Arandela Plana M6



D

x1 Allen Key 4 x 65MM *
x1 Clé hexagonale 4 x 65MM
x1 Llave Allen 4 x 65MM

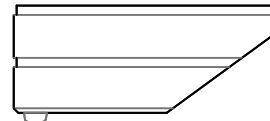

E

x1 Front Leg (Left) *
x1 Patte avant (Gauche)
x1 Pata delantera (Izquierda)

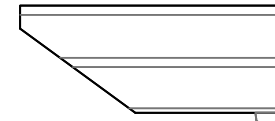

F

x1 Front Leg (Right) *
x1 Patte avant (Arrière)
x1 Pata delantera (Derecha)



G

x1 Back Leg (Left) *
x1 Patte arrière (Gauche)
x1 Pata trasera (Izquierda)

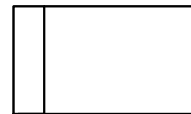

H

x1 Back Leg (Right) *
x1 Patte arrière (Arrière)
x1 Pata trasera (Derecha)

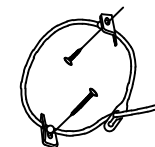

I

x1 Tipping restraint
x1 Liste des pièces de quincaillerie antibasculement
x1 Abrazadera antivuelco

**Replaceable Part*

ASSEMBLY INSTRUCTIONS / NOTICE DE MONTAGE / INSTRUCCIONES DE MONTAJE

ITEM NO. / ARTICLE NO. / ARTICULO NO : S462-440

DESCRIPTION / DESCRIPCIÓN : CHEST / COMMODE / CÓMODA

WARNING



Children have died from furniture tipover. To reduce the risk of furniture tipover:

- ALWAYS install tipover restraint provided.
- NEVER put a TV on this product.
- NEVER allow children to stand, climb or hang on drawers, doors, or shelves.
- NEVER open more than one drawer at a time.
- Place heaviest items in the lowest drawers.

This is a permanent label. Do not remove!

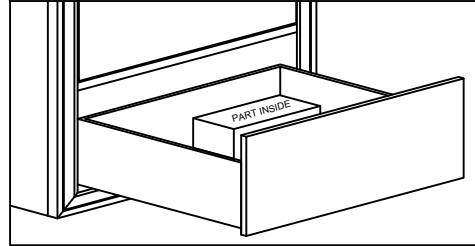

HARDWARE & LEGS (PACKED INSIDE DRAWER)
 QUINCAILLERIE ET PIEDS (EMBALLÉS À L'INTÉRIEUR DU TIROIR)
 HERRAJES Y PATAS (EMPAQUETADO DENTRO DEL CAJÓN

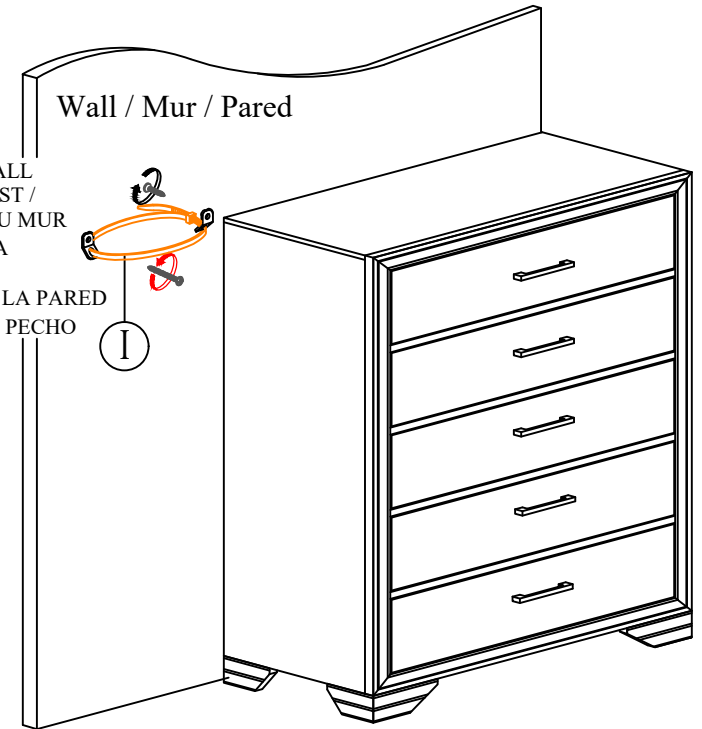
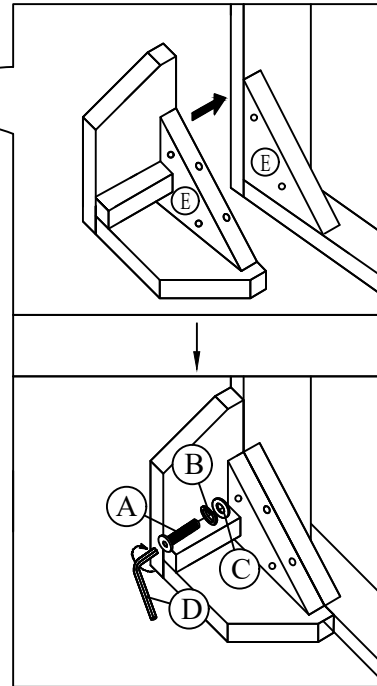
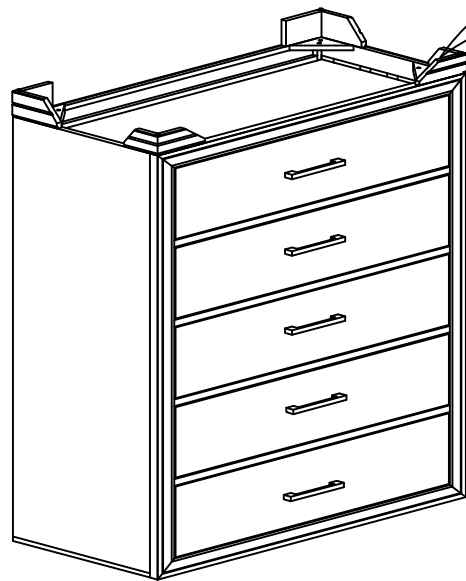

AFFIX TO WALL
 BEHIND CHEST /
 KENAFFIX AU MUR
 DERRIÈRE LA
 POITRINE /
 KENAFFIX A LA PARED
 DETRÁS DEL PECHO

**Replaceable Part*

REPLACEABLE PART / PARTIE REMPLAÇABLE / PARTE REEMPLAZABLE

ITEM NO. / ARTICLE NO. / ARTICULO NO : S462-440

DESCRIPTION / DESCRIPCIÓN : CHEST / COMMUNE / CÓMODA

WARNING

Children have died from furniture tipover. To reduce the risk of furniture tipover:

- ALWAYS install tipover restraint provided.
- NEVER put a TV on this product.
- NEVER allow children to stand, climb or hang on drawers, doors, or shelves.
- NEVER open more than one drawer at a time.
- Place heaviest items in the lowest drawers.

This is a permanent label. Do not remove!

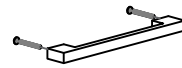

x5 RS462-410- PULL *
Pull with Screw
Tirer + vis
Tire + Tornillo

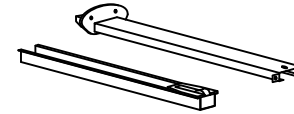

x5 RS462-410-DG *
Drawer Glide
Glissière
Carril de deslizamiento

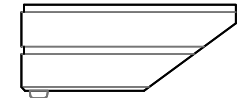

x4 RS462-410-LEG *
Legs
Jambes
Piernas

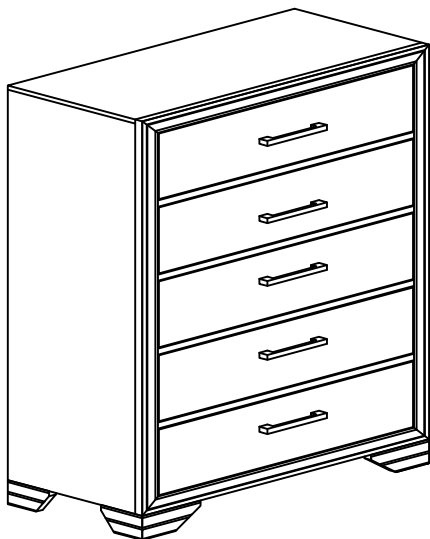

x4 RC-BR-NAIL *
Brown Plastic Nail
Clou en plastique
Clavo de plástico

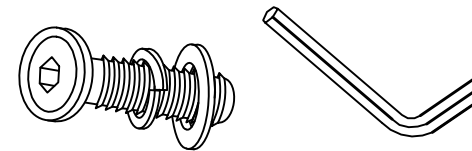

x1 RS462-410-HWKIT *
Hardware Kit
Liste des pièces de quincaillerie
Lista del kit de materiales

**Replaceable Part*