



PARTS LIST / LISTE DES PIÈCES / LISTA DE PIEZAS

ITEM NO. / ARTICLE NO. / ARTICULO NO. : 21220

DESCRIPTION / DESCRIPCIÓN : CORNER CURIO / CURIO EN COIN / VITRINA DE ESQUINA

**WARNING**

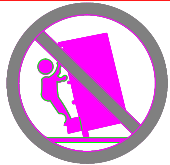

**Serious or fatal crushing injuries can occur from furniture tip-over. To help prevent tip-over:**

- install tipover restraint provided.
- Place heaviest items in the lowest drawers.
- Do not set TV's or other heavy objects on top of this product unless the product is specifically designed to accommodate them.
- Never allow children to climb or hang on drawers, doors, or shelves.
- Never open more than one drawer at a time (OR)
- Do not defeat or remove the drawers interlock system.

**Use of tip-over restraints may only reduce, but not eliminate, the risk of tip-over. this is a permanent label. Do not remove!**

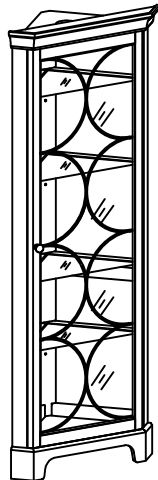
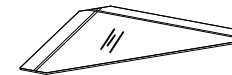
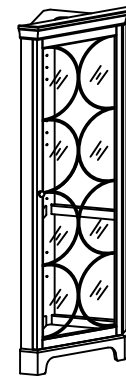

**A**

x1 Corner Curio  
x1 Curio en coin  
x1 Vitrina de esquina

**B**

x4 Glass shelf \*  
x4 Étagère en verre  
x4 Estante de vidrio

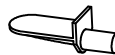

**C**

x8 Common Shelf Support Flat \*  
x8 Supports Pour Tablette  
x8 Soporte De Las Repisas



**D**

x4 Common Shelf Support Slot \*  
x4 Supports Pour Tablette  
x4 Soporte De Las Repisas



**E**

x1 Furniture Tipping Restraint  
x1 Systeme antibasculement  
x1 Control para evitar vulcos

\* Replaceable Part

**▲ WARNING**



**Serious or fatal crushing injuries can occur from furniture tip-over. To help prevent tip-over:**

- install tipover restraint provided.
- Place heaviest items in the lowest drawers.
- Do not set TV's or other heavy objects on top of this product unless the product is specifically designed to accommodate them.
- Never allow children to climb or hang on drawers, doors, or shelves.
- Never open more than one drawer at a time (OR)
- Do not defeat or remove the drawers interlock system.

**Use of tip-over restraints may only reduce, but not eliminate, the risk of tip-over. this is a permanent label. Do not remove!**

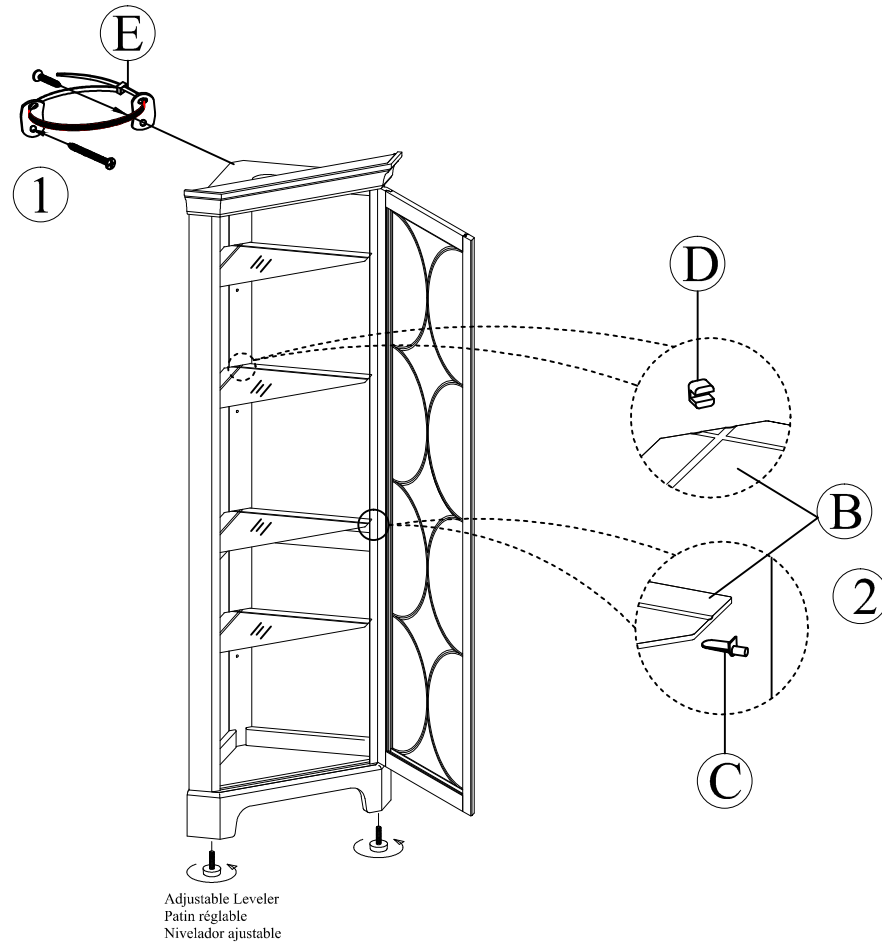
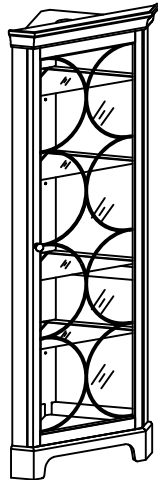



REPLACEABLE PART / PARTIE REMPLACABLE / PARTE REEMPLAZABLE  
 ITEM NO. / ARTICLE NO. / ARTICULO NO. : 21220  
 DESCRIPTION / DESCRIPCIÓN : CORNER CURIO / CURIO EN COIN / VITRINA DE ESQUINA

**▲ WARNING**



**Serious or fatal crushing injuries can occur from furniture tip-over. To help prevent tip-over:**

- install tipover restraint provided.
- Place heaviest items in the lowest drawers.
- Do not set TV's or other heavy objects on top of this product unless the product is specifically designed to accommodate them.
- Never allow children to climb or hang on drawers, doors, or shelves.
- Never open more than one drawer at a time (OR)
- Do not defeat or remove the drawers interlock system.

**Use of tip-over restraints may only reduce, but not eliminate, the risk of tip-over. this is a permanent label. Do not remove!**

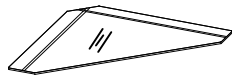
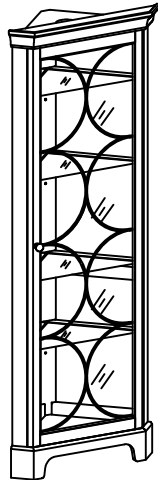

x4 R21220-63  
 Glass shelf \*  
 Étagère en verre  
 Estante de vidrio



x1 R141253-40  
 Knob \*  
 Poignée  
 Tirador



x4 RC-SUPPORT-04  
 Common Shelf Support Slot \*  
 Supports Pour Tablette  
 Soporte De Las Repisas



x4 R21220-40 \*  
 Hinge  
 Charnière  
 Bisagra



x8 RC-SUPPORT-03  
 Common Shelf Support Flat \*  
 Supports Pour Tablette  
 Soporte De Las Repisas



x2 R21220-CATCH  
 Door Catch \*  
 Catch de aimant  
 Captura de imán

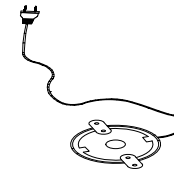

x1 RC-LIGHT-04  
 Single Halogen Light w/roll switch \*  
 lampe à halogène et interrupteur  
 lámpara halógena y interruptor

\* Replaceable Part