

PARTS LIST / LISTE DES PIÈCES / LISTA DE PIEZAS

ITEM NO. / ARTICLE NO. / ARTICULO NO : P301011

DESCRIPTION/LA DESCRIPCION/DESCRIPCIÓN :Media Console/Console multimédia/Módulo de consola



A *

x2 Adjustable Side Shelf
x2 Tablette ajustable
x2 Estante ajustable

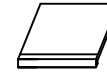

B *

x2 Adjustable Middle Shelf
x2 Tablette ajustable
x2 Estante ajustable

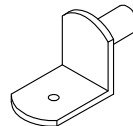

C *

x16 Shelf Supports
x16 Supports Pour Tablette
x16 Soporte De Las Repisas



D *

x1 Tipping restraint
x1 Liste des pièces de quincaillerie antibasculément
x1 Abrazadera antivuelco



E *

x5 Adjustable leveler-Black
x5 Patin réglable
x5 Nivelador ajustable

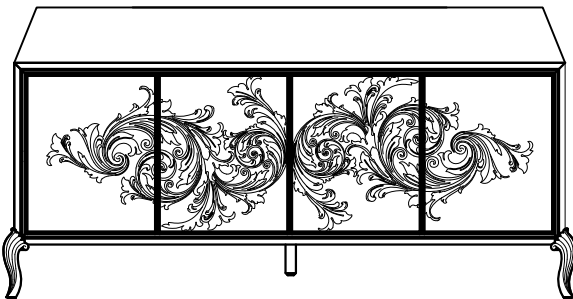

* Replaceable Part

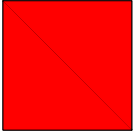

ASSEMBLY INSTRUCTIONS/ NOTICE DE MONTAGE/ INSTRUCCIONES DE MONTAJE

ITEM NO. / ARTICLE NO. / ARTICULO NO : P301011

DESCRIPTION/LA DESCRIPCION/DESCRIPCIÓN :Media Console/Console multimédia/Módulo de consola

⚠ WARNING

Children have died from furniture tipover. To reduce the risk of furniture tipover:

- ALWAYS install tipover restraint provided.
- For use with televisions weighing 170 lbs (77.11 kgs) or less .Use with heavier televisions may result in instability causing tip-over resulting in death or serious injury.
- NEVER allow children to stand, climb or hang on drawers, doors, or shelves.
- NEVER open more than one drawer at a time.
- Place heaviest items in the lowest drawers.

This is a permanent label. Do not remove!

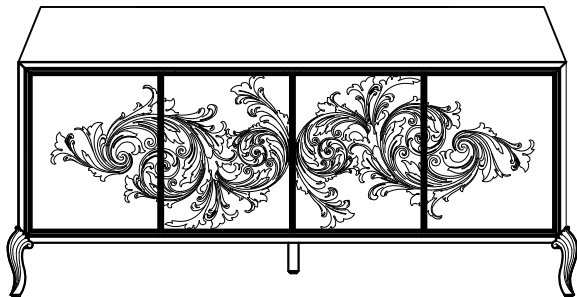
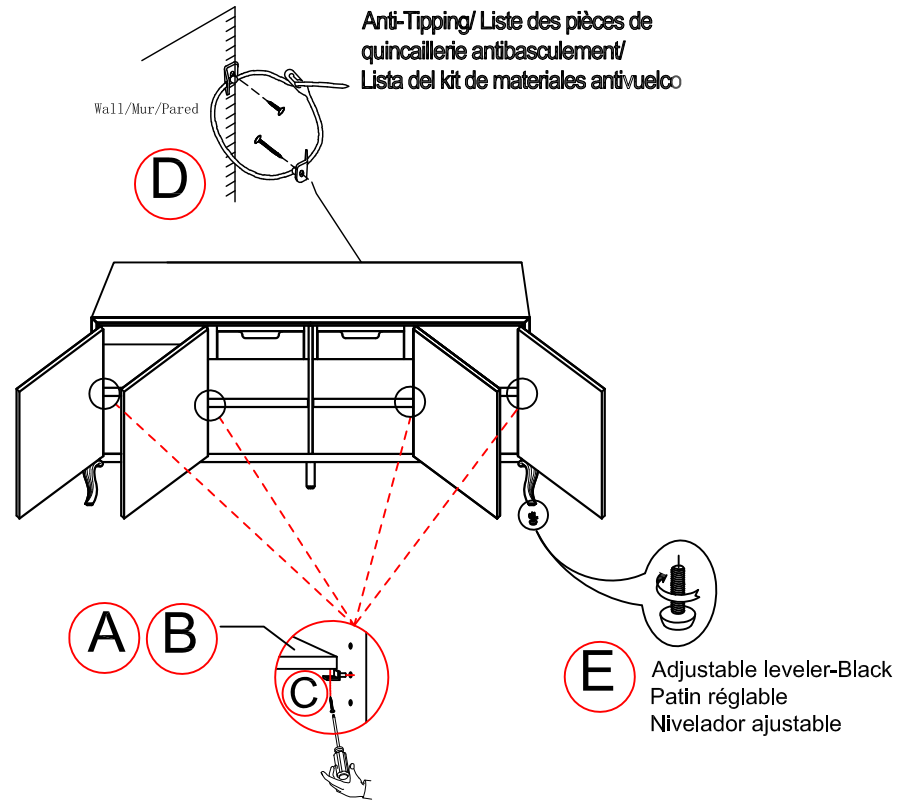
* Replaceable Part

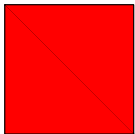

REPLACEABLE PART/ PARTIE REMPLACABLE/ PARTE REEMPLAZABLE

ITEM NO. / ARTICLE NO. / ARTICULO NO : P301011

DESCRIPTION/LA DESCRIPCION/DESCRIPCIÓN :Media Console/Console multimédia/Módulo de consola

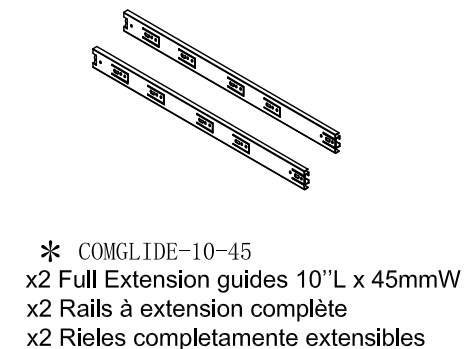
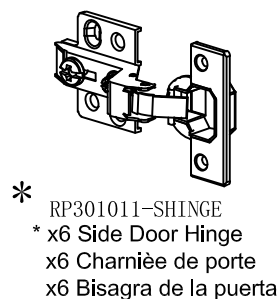
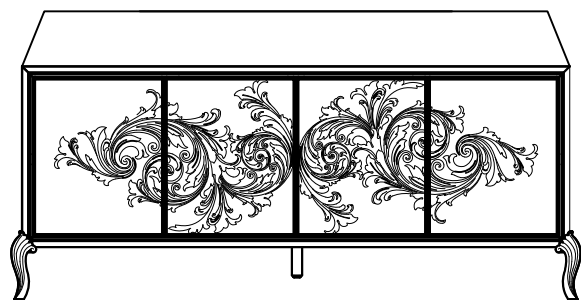
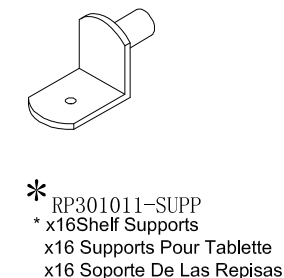
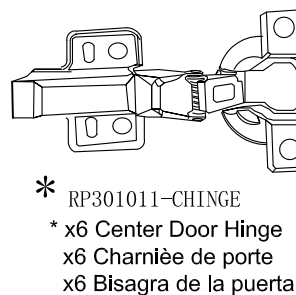
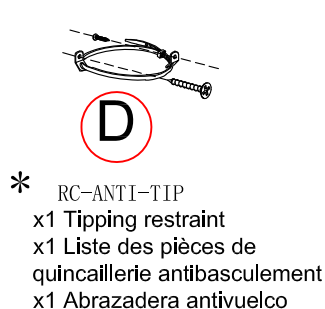
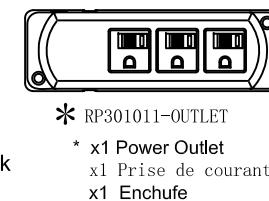
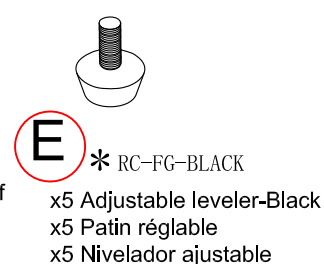
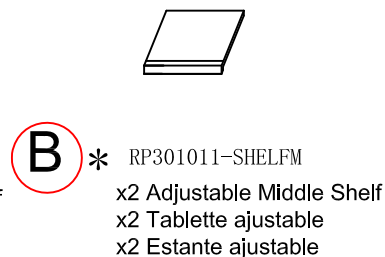
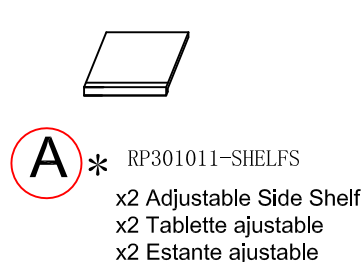

* Replaceable Part