

PARTS LIST / LISTE DES PIÈCES / LISTA DE PIEZAS

ITEM / NO D'ARTICLE / ARTICULO : S952-270/271/406

DESCRIPTION / DESCRIPTION: 6/6 UPH Panel HB - Roi tête de lit rembourrée - Rey cabecera tapizada

6/6 Panel FB & Slat Roll - Pied de très grand lit standard et californien avec lattes - Pie de cama y listones de 6/6

6/0 Side Rails - Traverses de très grand lit californien - Travesaños laterales de 6/0

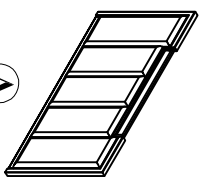
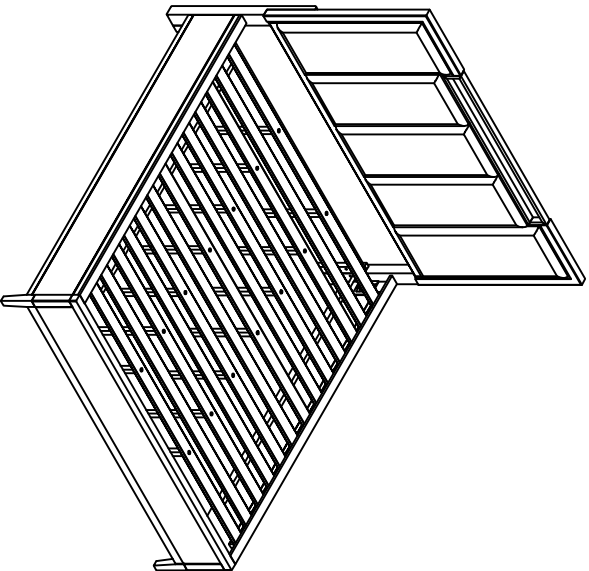

- x1 Headboard panel
- x1 Tête de lit
- x1 Panel de la cabecera

A

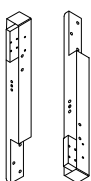

- x2 Headboard Legs* (Left & Right) *
- x2 Pattes de la tête de lit (gauche et droite)
- x2 Patas de cabecera (izquierda y derecha)

B

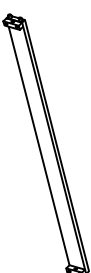

- x1 Safety Rail*
- x1 Garde-corps
- x1 Baranda de seguridad

C

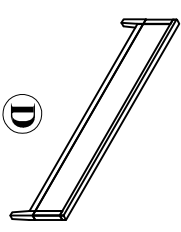

- x1 Footboard Panel
- x1 Pied de lit
- x1 Panel de pie de cama

D

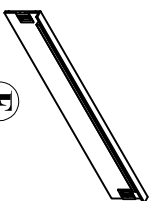

- x2 Side Rail
- x2 Traverse
- x2 Travesaño lateral

E

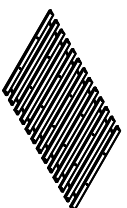

- x1 Slat Roll
- x1 Banes de lit
- x1 Listones

F



- x14 Slat Support Leg *
- x14 Pattes centrales
- x14 Patas centrales

G

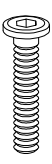

- x8 Allen bolt Ø5/16"-18 x 45mm *
- x8 Vis à tête creuse hexagonale Ø5/16"-18 x 45mm
- x8 Perno Allen Ø5/16"-18 x 45mm

I



- x16 Lock washer Ø5/16" *
- x16 Rondelle de blocage Ø5/16"
- x16 Arandela de Seguridad Ø5/16"

2



- x8 Flat Washer Ø5/16"x19x1.5mm *
- x8 Rondelle plate Ø5/16"x19x1.5mm
- x8 Arandela plana Ø5/16"x19x1.5mm

3



- x8 Flat Washer Ø5/16"x16x1.5mm *
- x8 Rondelle plate Ø5/16"x16x1.5mm
- x8 Arandela plana Ø5/16"x16x1.5mm

4



- x1 Allen Key 4mm *
- x1 Clé hexagonale 4mm
- x1 Llave Allen 4mm

5



- x8 Hanger bolt Ø5/16x 88mm *
- x8 Boulon-vis Ø5/16x 88mm
- x8 Perno de suspensión Ø5/16x 88mm

6



- x8 Hex nut *
- x8 Écrou hexagonal
- x8 Tuerca hexagonal

7



- x1 Hex Wrench*
- x1 Clé hexagonale
- x1 Llave hexagonal

8



- x26 Wood Screw #8x35mm *
- x26 Vis à bois #8x35mm
- x26 Tornillo para madera #8x35mm

9

** Replaceable Part*

ITEM / NO D'ARTICLE / ARTICULO : S952-270/271/406

DESCRIPTION / DESCRIPTION: 6/6 UPH Panel HB - Roi tête de lit rembourrée - Rey cabecera tapizada

6/6 Panel FB & Slat Roll - Pied de très grand lit standard et californien avec lattes - Pie de cama y listones de 6/6

6/0 Side Rails - Traverses de très grand lit californien - Travesaños laterales de 6/0

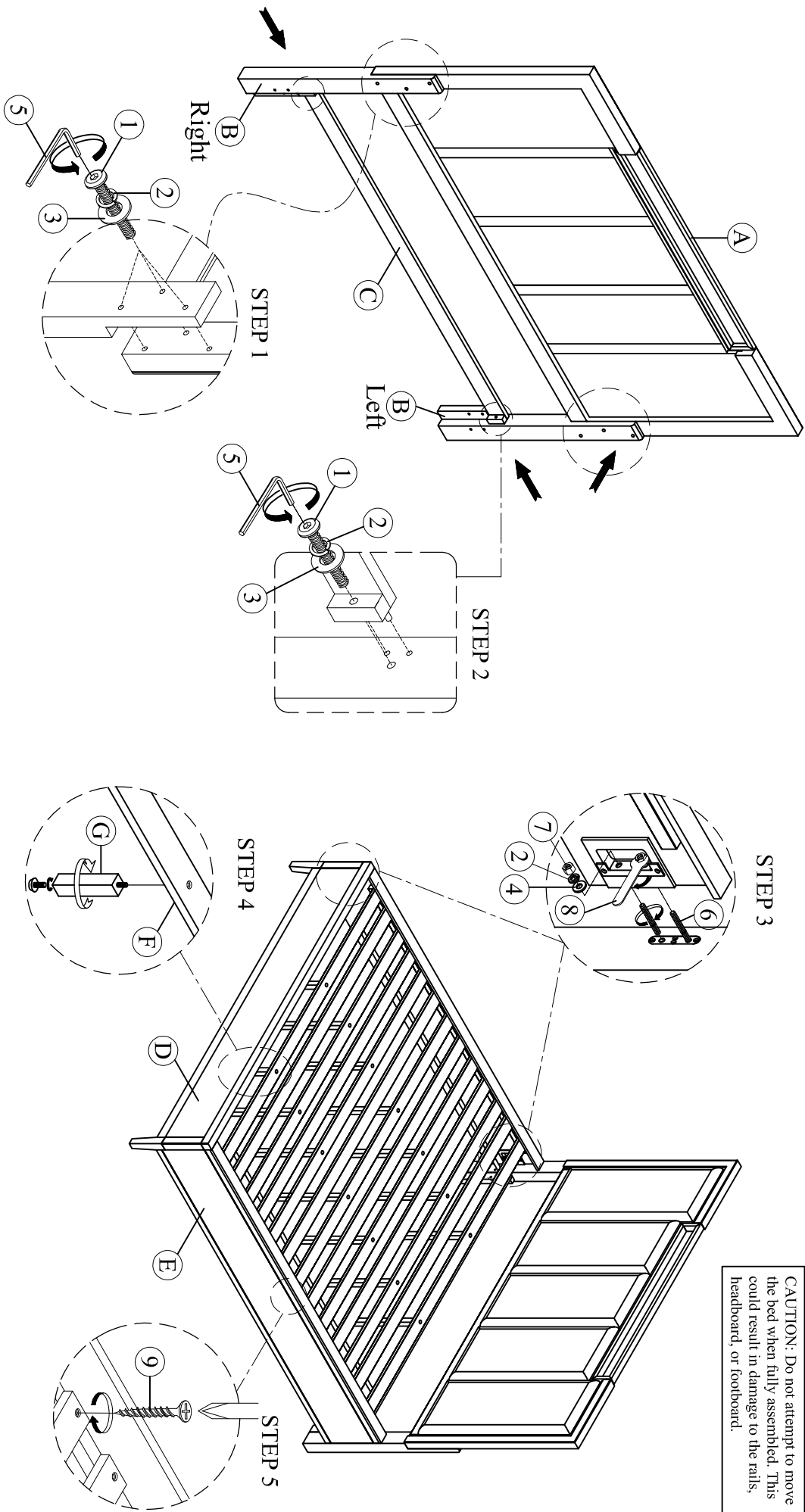

* Replaceable Part

REPLACEABLE PART / PARTIE REMPLAÇABLE / PARTE REEMPLAZABLE

ITEM / NO D'ARTICLE / ARTICULO : S952-270/271/406

DESCRIPTION / DESCRIPTION: 6/6 UPH Panel HB - Roi tête de lit rembourrée - Rey cabecera tapizada

6/6 Panel FB & Slat Roll - Pied de très grand lit standard et californien avec lattes - Pie de cama y listones de 6/6

6/0 Side Rails - Traverses de très grand lit californien - Travesaños laterales de 6/0

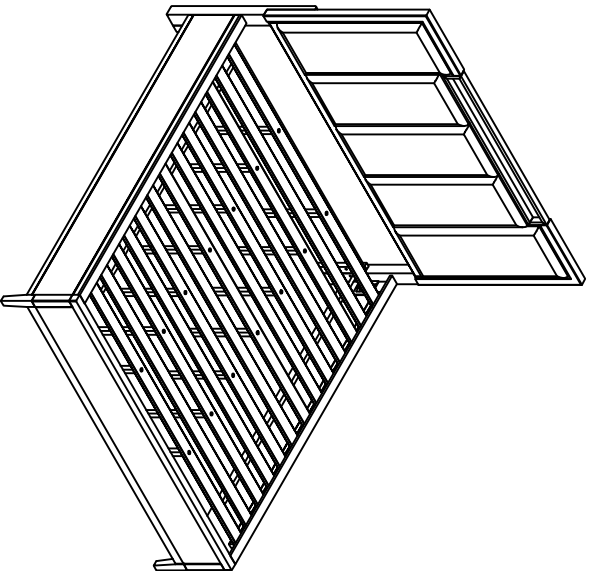

x1 RS952-250-LEGL- Left Leg *
Patte de gauche
Pata izquierda

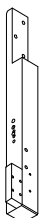

x1 RS952-250 - LEGR -Right Leg *
Patte de droite
Pata derecha

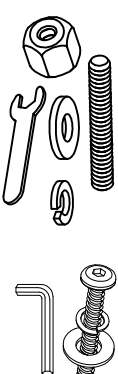

x1 RS952-250 HWKIT-Hardware kit list *
Liste des pièces de quincaillerie
Lista del kit de materiales

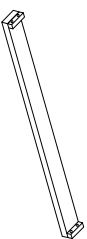

x1 RS952-270-R-ALL- Safety Rail *
Garde-corps
Baranda de seguridad



x14 RS952-251- SUP - Slat Support Leg with levelers *
Pattes centrales avec patin réglable
Patas centrales con nivelador ajustable



x26 RS952-251- SCREW-Screw *
Vis à bois
Tomillo para madera

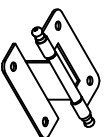

x8 RS952-406- HINGE-Door Hinge
Channière de porte
Bisagra de la puerta

**Replaceable Part*

Protect Your Wood or Laminate Flooring

*This statement applies to any floor without carpet.

If not careful, all furniture including upholstery and case pieces can scratch, scuff and even gouge floors. The recommendation is to have felt, rubber pads or area rugs under furniture on flooring without carpet.

Moving your furniture

Pushing and dragging furniture over floors without carpet can lead to scratches and scuffs. Have someone help when moving the larger pieces of furniture by lifting, try using a dolly or moving pads.

Felt and rubber pads

Applying furniture pads to the feet of furniture helps cushion contact points. Furniture pads can be found at local hardware stores. Felt pads slide easily across the floor, making them ideal for dining chairs and other pieces that move with use. Rubber pads will help furniture stay in place and are perfect for larger pieces, like sofas and loveseats.

Area rugs and rug pads

Using an area rug under furniture is another way to protect your floor from scratches and scuff marks. A rug pad under the area rug will provide extra cushion and added protection.