	<b>WARNING</b>
	
<p>Children have died from furniture tipover. To reduce the risk of furniture tipover:</p> <ul style="list-style-type: none"> <li>· ALWAYS install Anti-tip device provided.</li> <li>· NEVER put a TV on this product.</li> <li>· NEVER allow children to stand, climb or hang on any drawers, doors, or shelves.</li> <li>· NEVER open more than one drawer at a time.</li> <li>· PLACE heaviest items in the lowest drawers.</li> </ul> <p>This is a permanent label. Do not remove!</p>	

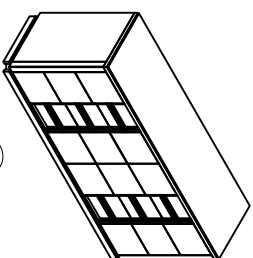

**(A)**

x1 Dresser  
x1 Commode  
x1 Tocador



**(B)**

x4 Leg \*  
x4 Pate  
x4 Pata



**(C)**

x1 Center support leg \*  
x1 Support central  
x1 Sopoite para la pata centra

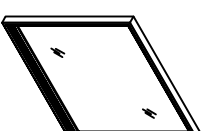

**(D)**

x1 Mirror  
x1 Miroir  
x1 Espejo

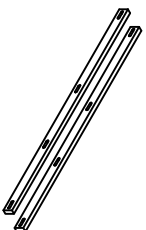

**(E)**

x2 Mirror Support \*  
x2 Supporte de miroir  
x2 Sopoite del espejo



**(F)**

x1 Furniture Tipping Restraint \*  
x1 Systeme antibasculement  
x1 Control para evitar vuelcos

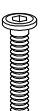

**(1)**

x8 Allen bolt Ø5/16"-18 x 50mm \*  
x8 Vis à tête creuse hexagonale Ø5/16"-18 x 50mm  
x8 Perno Allen Ø5/16"-18 x 50mm



**(2)**

x8 Lock washer Ø5/16" \*  
x8 Rondelle de blocage Ø5/16"  
x8 Arandela de Seguridad Ø5/16"



**(3)**

x8 Flat Washer Ø5/16"x19x1.5mm \*  
x8 Rondelle plate Ø5/16"x19x1.5mm  
x8 Arandela plana Ø5/16"x19x1.5mm

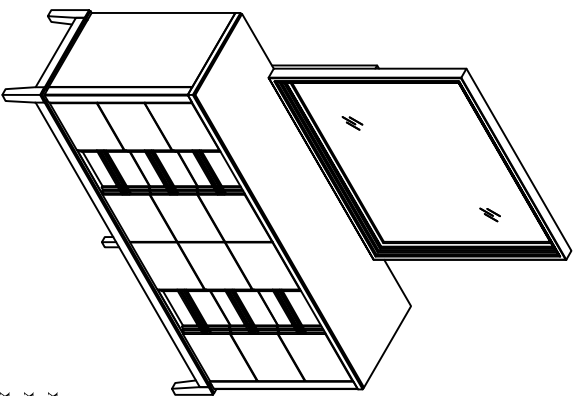

**(4)**

x8 Allen bolt Ø1/4"x30mm \*  
x8 Vis à tête creuse hexagonale Ø1/4"x30mm  
x8 Perno Allen Ø1/4"x30mm



**(5)**

x8 Lock washer Ø1/4" \*  
x8 Rondelle de blocage Ø1/4"  
x8 Arandela de Seguridad Ø1/4"



**(6)**

x8 Flat Washer Ø1/4"x19x1.5mm \*  
x8 Rondelle plate Ø1/4"x19x1.5mm  
x8 Arandela plana Ø1/4"x19x1.5mm

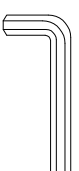



**(7)**

x2 Allen Key 4mm \*  
x2 Clé hexagonale 4mm  
x2 Llave Allen 4mm

\* Replacable Part

# HFH HOOKER FURNISHINGS

ASSEMBLY INSTRUCTIONS / NOTICE DE MONTAGE / INSTRUCCIONES DE MONTAJE  
 ITEM / NO D' ARTICLE / ARTICULO : S952-010/S952-030  
 DESCRIPTION / DESCRIPTION : Drawer Dresser - Commode - Tecedor  
 Beveled Mirror - Miroir - Espejo

	<b>WARNING</b>
	
<p>Children have died from furniture tipover. To reduce the risk of furniture tipover:</p> <ul style="list-style-type: none"> <li>· ALWAYS install Anti-tip device provided.</li> <li>· NEVER put a TV on this product.</li> <li>· NEVER allow children to stand, climb or hang on any drawers, doors, or shelves.</li> <li>· NEVER open more than one drawer at a time.</li> <li>· PLACE heaviest items in the lowest drawers.</li> </ul> <p>This is a permanent label. Do not remove!</p>	

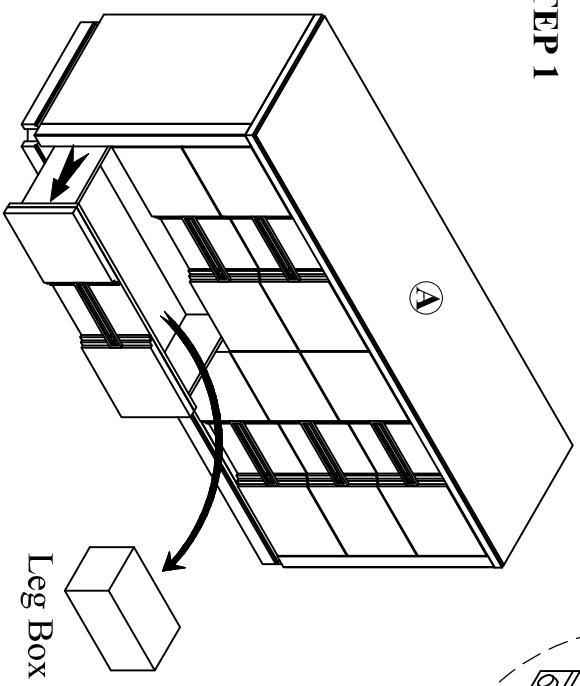

## STEP 1

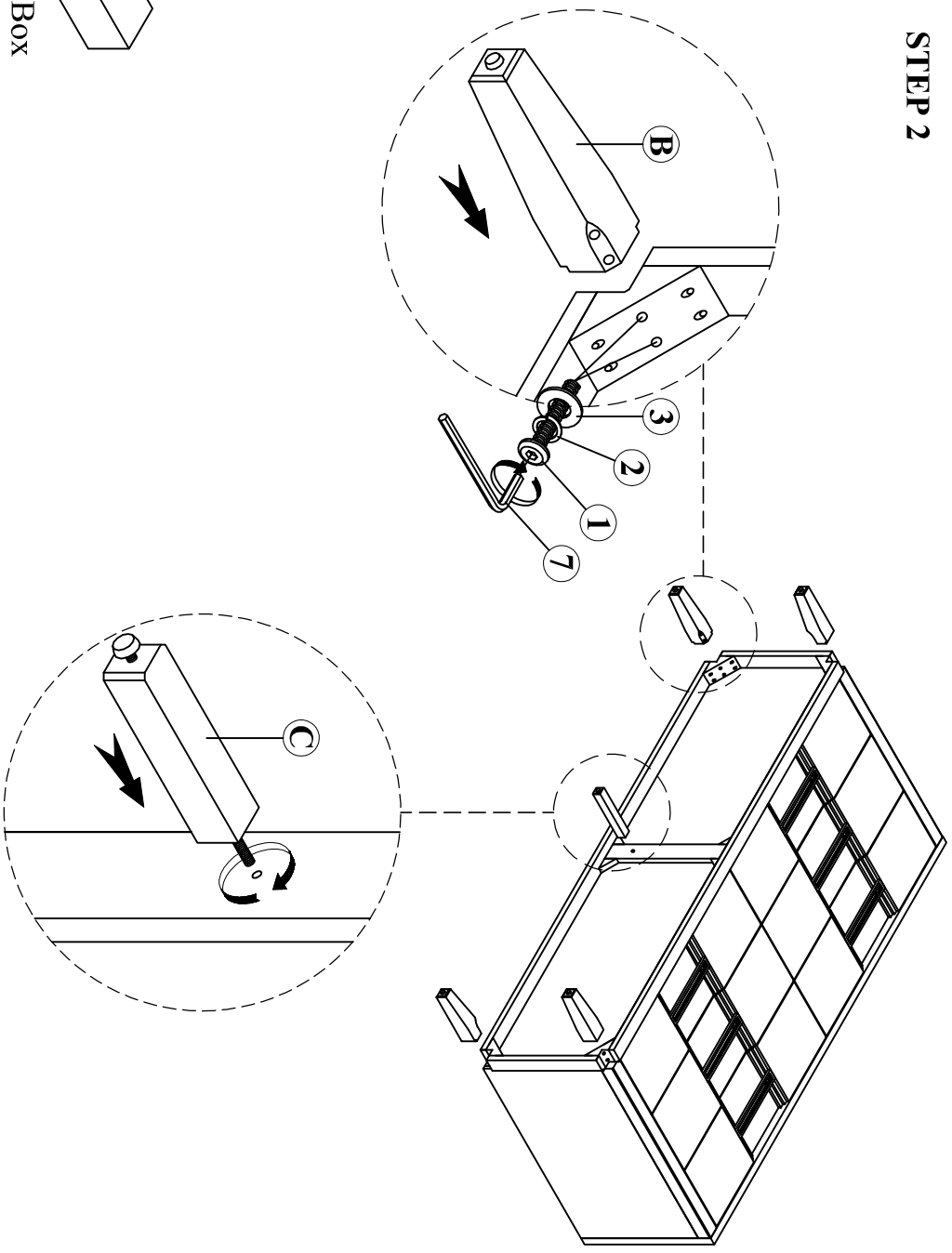

## STEP 2



*\*Replaceable Part*

	
<b>WARNING</b>	
<p>Children have died from furniture tipover. To reduce the risk of furniture tipover:</p> <ul style="list-style-type: none"> <li>· ALWAYS install Anti-tip device provided.</li> <li>· NEVER put a TV on this product.</li> <li>· NEVER allow children to stand, climb or hang on any drawers, doors, or shelves.</li> <li>· NEVER open more than one drawer at a time.</li> <li>· PLACE heaviest items in the lowest drawers.</li> </ul> <p>This is a permanent label. Do not remove!</p>	

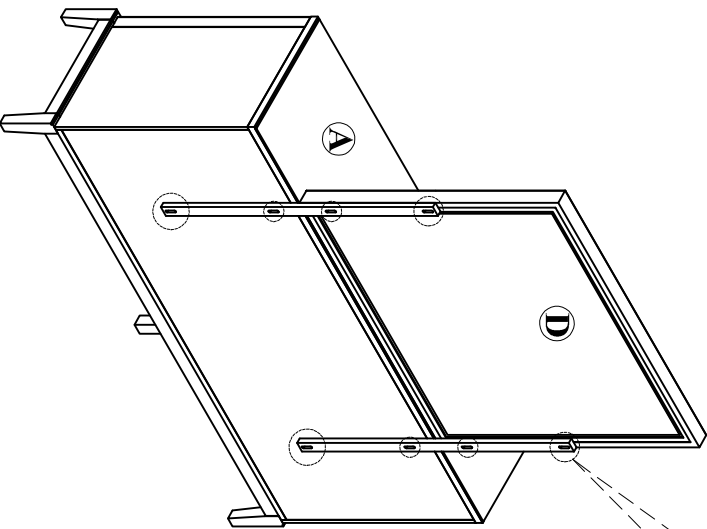

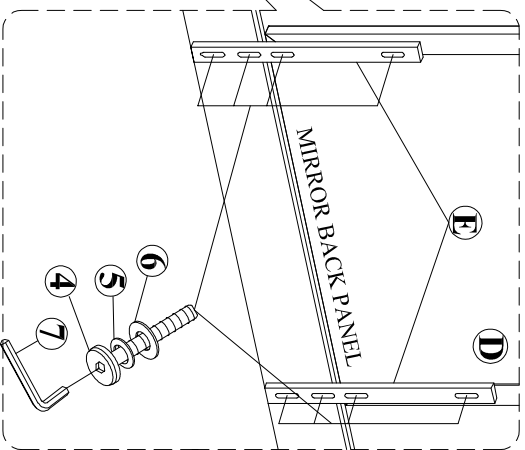

### STEP 3

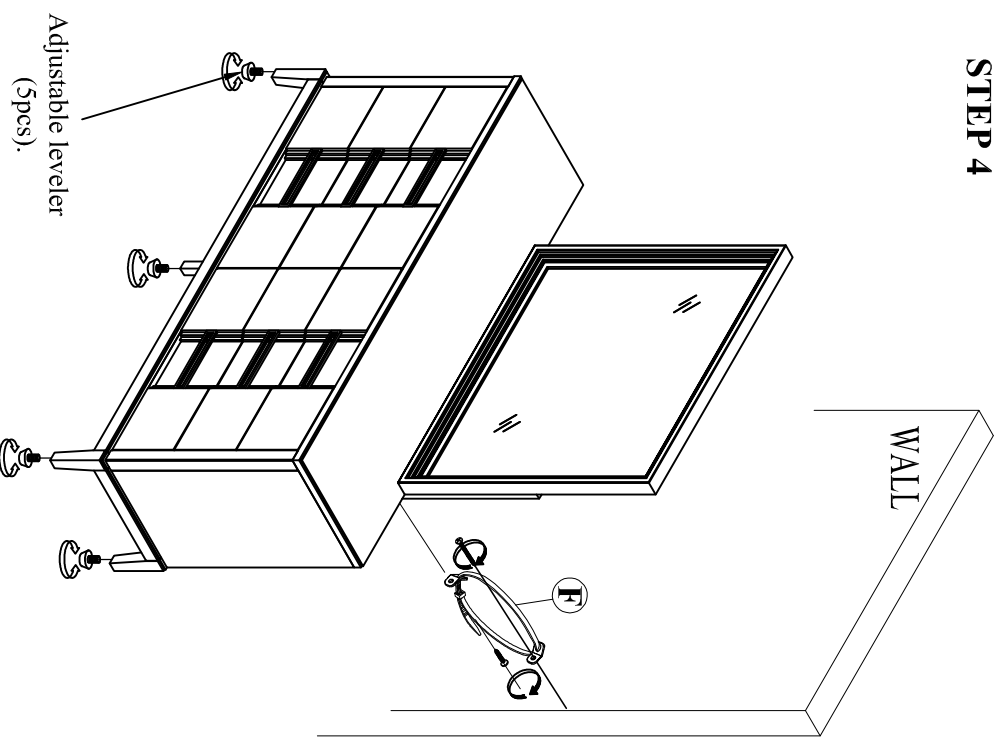

### STEP 4



\* Replaceable Part

	
<b>WARNING</b>	
<p>Children have died from furniture tipover. To reduce the risk of furniture tipover:</p> <ul style="list-style-type: none"> <li>· ALWAYS install Anti-tip device provided.</li> <li>· NEVER put a TV on this product.</li> <li>· NEVER allow children to stand, climb or hang on any drawers, doors, or shelves.</li> <li>· NEVER open more than one drawer at a time.</li> <li>· PLACE heaviest items in the lowest drawers.</li> </ul> <p>This is a permanent label. Do not remove !</p>	

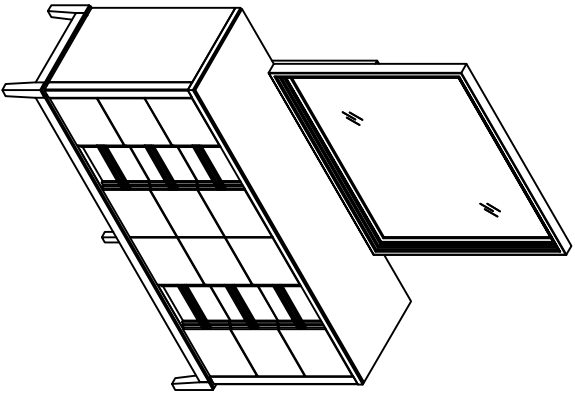

x6 GLIDE-SS-12-10-45- Glide SS 12in open 10in - 45mm \*  
 Tiroir Glide  
 Deslizamiento del cajón

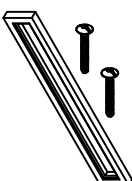

x6 RS952-010-PULL- Pull+ Screw \*  
 Poignée + vis  
 Tirador + Tornillo



x4 RS952-010-LEG- Leg  
 Patte  
 Pata

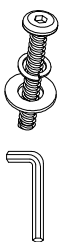

x1 RS952-010-HWKIT- Hardware kit list  
 Liste des pièces de quincaillerie  
 Lista del kit de materiales



x1 RS952-010-CELE- Center support leg  
 Support central  
 Soporte para la pata central



x5 RC-FG-WHITE- White leveler  
 Patin réglable  
 Nivelador ajustable



x1 RC-ANTI-TIP- Anti-tipping restraint  
 Liste des pièces de quincaillerie antibasculement  
 Lista del kit de materiales antivuelco

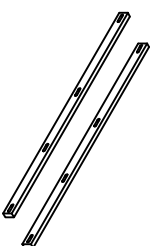

x2 RS952-030-MISU- Mirror Support \*  
 Supporte de miroir  
 Soporte del espejo



x1 RS952-030-HWKIT- Hardware kit list  
 Liste des pièces de quincaillerie  
 Lista del kit de materiales

*\* Replaceable Part*

## **Protect Your Wood or Laminate Flooring**

\*This statement applies to any floor without carpet.

If not careful, all furniture including upholstery and case pieces can scratch, scuff and even gouge floors. The recommendation is to have felt, rubber pads or area rugs under furniture on flooring without carpet.

### **Moving your furniture**

Pushing and dragging furniture over floors without carpet can lead to scratches and scuffs. Have someone help when moving the larger pieces of furniture by lifting, try using a dolly or moving pads.

### **Felt and rubber pads**

Applying furniture pads to the feet of furniture helps cushion contact points. Furniture pads can be found at local hardware stores. Felt pads slide easily across the floor, making them ideal for dining chairs and other pieces that move with use. Rubber pads will help furniture stay in place and are perfect for larger pieces, like sofas and loveseats.

### **Area rugs and rug pads**

Using an area rug under furniture is another way to protect your floor from scratches and scuff marks. A rug pad under the area rug will provide extra cushion and added protection.