

ITEM / NO D'ARTICLE / ARTICULO : S916-270/271/400

DESCRIPTION / DESCRIPTION: 6/6 King Panel Headboard - Tête de très grand lit - Cabecera King
6/6 King Panel FB - Pied de très grand lit - Pie de cama king
5/0-6/6 Set of Side Rails - Traverses de grand lit et très grand lit - Juego de travesaños laterales de cama de 5/0 y 6/6

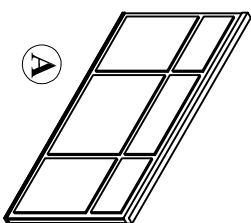
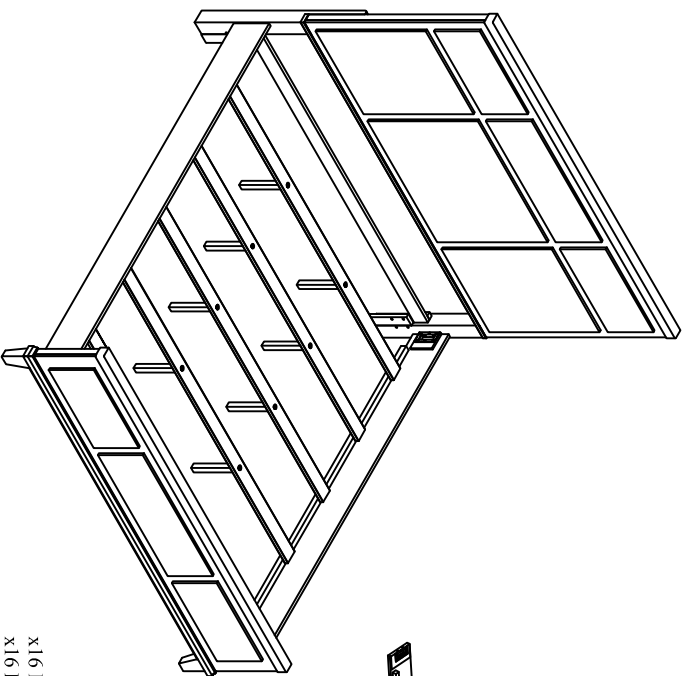

- x1 Headboard panel
- x1 Tête de lit
- x1 Panel de la cabecera

A

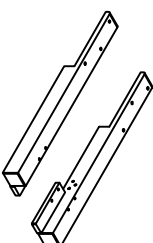

- x2 Headboard Legs (Left & Right) *
- x2 Parties de la tête de lit (gauche et droite)
- x2 Patas de cabecera (izquierda y derecha)

B

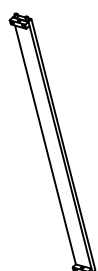

- x1 Safety Rail *
- x1 Garde-corps
- x1 Baranda de seguridad

C

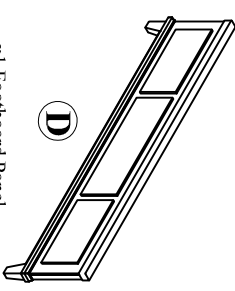

- x1 Footboard Panel
- x1 Pied de lit
- x1 Panel de pie de cama

D



- x2 Side Rail
- x2 Traverse
- x2 Travesaño lateral

E



- x5 Slats *
- x5 Bancos de lit
- x5 Listones

F

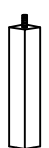

- x10 Center leg *
- x10 Patas centrales
- x10 Patas centrales

G

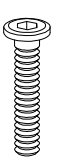

- x8 Allen bolt Ø5/16" x18x45mm *
- x8 Vis à tête creuse hexagonale Ø5/16" x18x45mm
- x8 Perno Allen Ø5/16" x18x45mm

1



- x16 Lock washer Ø5/16" *
- x16 Rondelle de blocage Ø5/16"
- x16 Arandela de Seguridad Ø5/16"

2



- x8 Flat Washer Ø5/16" x19x1.5mm *
- x8 Rondelle plate Ø5/16" x19x1.5mm
- x8 Arandela plana Ø5/16" x19x1.5mm

3



- x8 Flat Washer Ø5/16" x16x1.5mm *
- x8 Rondelle plate Ø5/16" x16x1.5mm
- x8 Arandela plana Ø5/16" x16x1.5mm

4



- x1 Allen Key 4mm *
- x1 Clé hexagonale 4mm
- x1 Llave Allen 4mm

5



- x8 Hanger bolt Ø5/16" x88mm *
- x8 Boulon-vis Ø5/16x 88mm
- x8 Perno de suspensión Ø5/16x 88mm

6



- x8 Nuts Ø5/16" x13x8mm *
- x8 Écrou Ø5/16" x13x8mm
- x8 Tuercas Ø5/16" x13x8mm

7



- x1 Hex Wrench *
- x1 Clé hexagonale
- x1 Llave hexagonal

8



- x10 Wood Screw #8x35mm *
- x10 Vis à bois #8x35mm
- x10 Tornillo para madera #8x35mm

9

* Replaceable Part

H HOOKER FURNISHINGS

ASSEMBLY INSTRUCTIONS / NOTICE DE MONTAGE / INSTRUCCIONES DE MONTAJE
 ITEM / NO D' ARTICLE / ARTICULO : S916-270/271/400
 DESCRIPTION / DESCRIPCIÓN: 6/6 King Panel Headboard - Tête de très grand lit - Cabecera King

6/6 King Panel FB - Pied de très grand lit - Pie de cama king
 5/0-6/6 Set of Side Rails - Traverses de grand lit et très grand lit - Juego de travesaños laterales de cama de 5/0 y 6/6

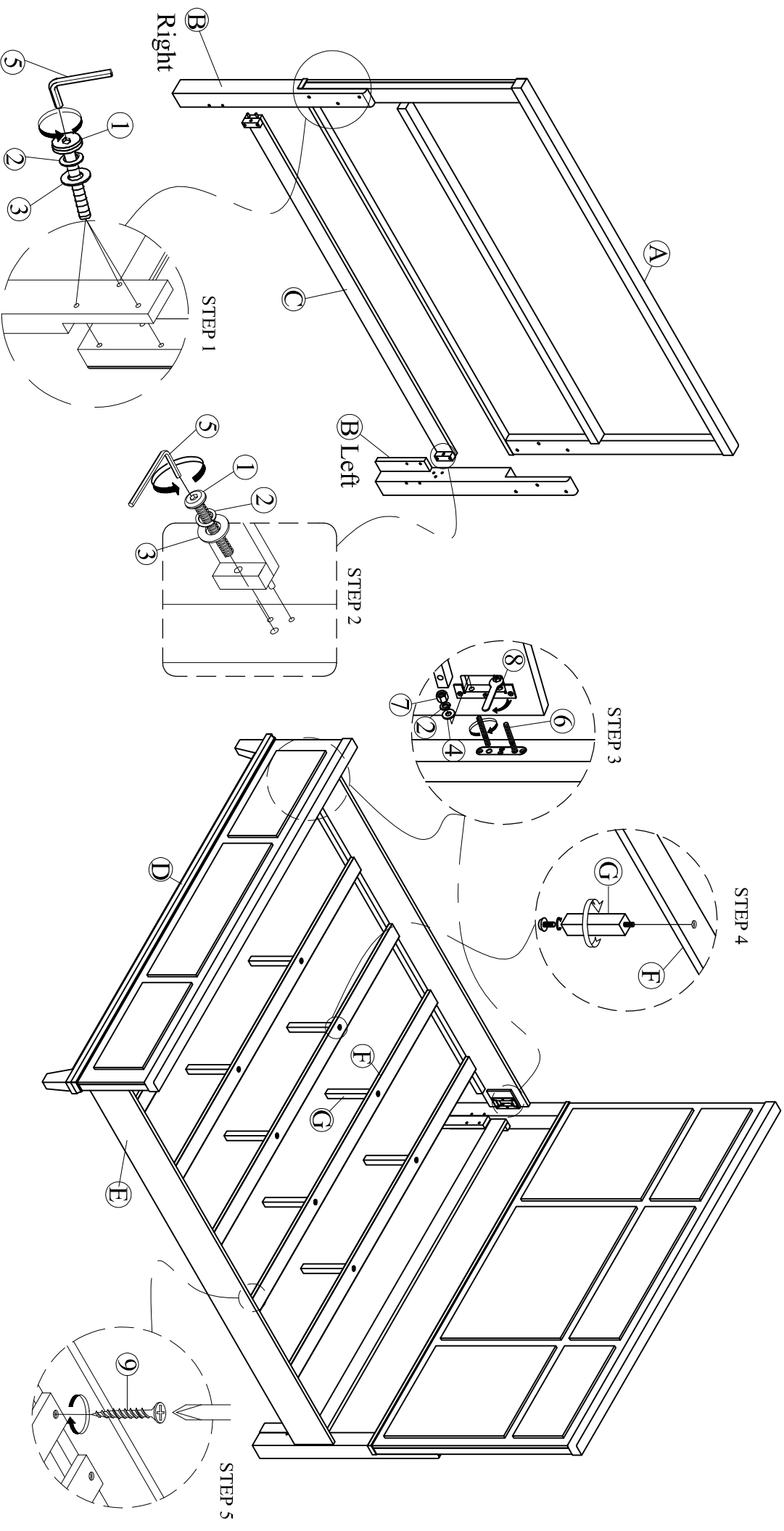

ITEM / NO D'ARTICLE / ARTICULO : S916-270/271/400

DESCRIPTION / DESCRIPTION: 6/6 King Panel Headboard - Tête de très grand lit - Cabecera King

6/6 King Panel FB - Pied de très grand lit - Pie de cama king

5/0-6/6 Set of Side Rails - Traverses de grand lit et très grand lit - Juego de travesaños laterales de cama de 5/0 y 6/6

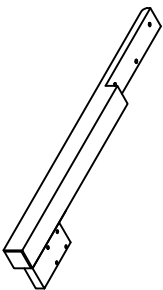
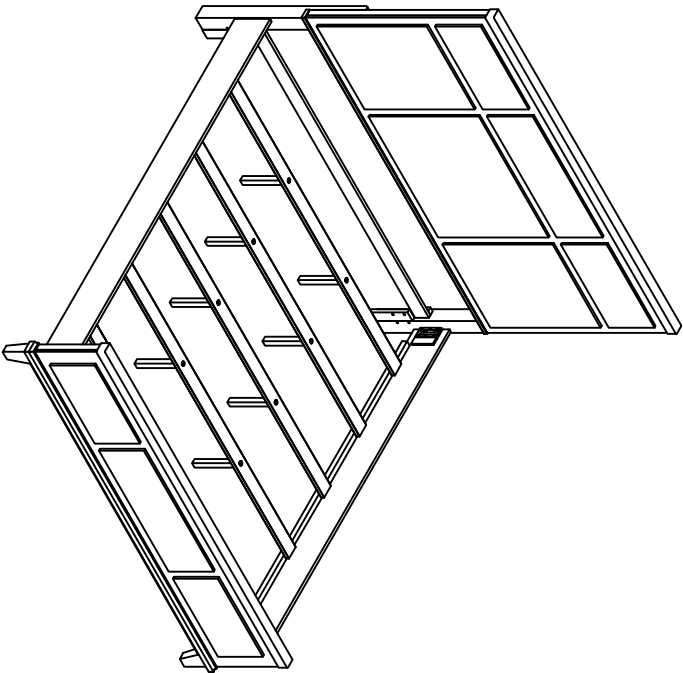

x1 RS916-270-LEGL - Left Leg *
Pate de gauche
Pata izquierda

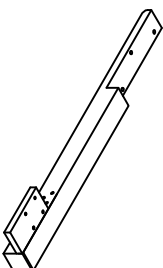

x1 RS916-270-LEGR -Right Leg *
Patte de droite
Pata derecha

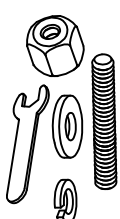

x1 RS916-270 HWKIT - Hardware kit list *
Liste des pièces de quincaillerie
Lista del kit de materiales

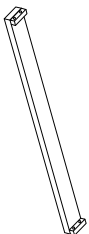
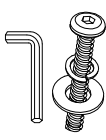

x1 RS916-270-RAIL - Safety Rai *
Garde-corps
Baranda de seguridad

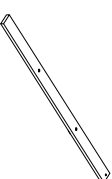

x5 RS916-271-SLAT-Slat *
Lattes
Listones



x10 RS916-271-SULEG - Center leg *
Pattes centrales
Patas centrales

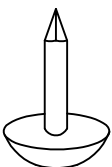

x4 RC-WH-NAIL - White plastic nail
Clou en plastique
Clavo de plástico

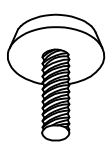

x10 RC-FG-WHITE-White leveler
Patin réglable
Nivelador ajustable



x10 RS916-251-SCREW-Screw *
Vis à bois
Tornillo para madera

* Replaceable Part

Protect Your Wood or Laminate Flooring

*This statement applies to any floor without carpet.

If not careful, all furniture including upholstery and case pieces can scratch, scuff and even gouge floors. The recommendation is to have felt, rubber pads or area rugs under furniture on flooring without carpet.

Moving your furniture

Pushing and dragging furniture over floors without carpet can lead to scratches and scuffs. Have someone help when moving the larger pieces of furniture by lifting, try using a dolly or moving pads.

Felt and rubber pads

Applying furniture pads to the feet of furniture helps cushion contact points. Furniture pads can be found at local hardware stores. Felt pads slide easily across the floor, making them ideal for dining chairs and other pieces that move with use. Rubber pads will help furniture stay in place and are perfect for larger pieces, like sofas and loveseats.

Area rugs and rug pads

Using an area rug under furniture is another way to protect your floor from scratches and scuff marks. A rug pad under the area rug will provide extra cushion and added protection.