

HIF HOOKER PARTS LIST / LISTE DES PIÈCES / LISTA DE PIEZAS

ITEM / NO D' ARTICLE / ARTICULO : S916-135
 DESCRIPTION / DESCRIPCIÓN: Leg Table / Patte de table/ Pata de mesa

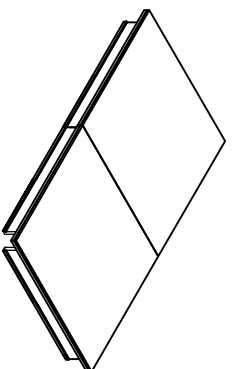

(A)

- x1 Table Top
- x1 Dessus de table
- x1 Tablero de mesa

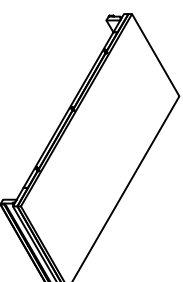

(B)

- x1 Table Leaf
- x1 Panneau de table
- x1 Extensión



(C)

- x4 Leg *
- x4 jambe
- x4 Pierna

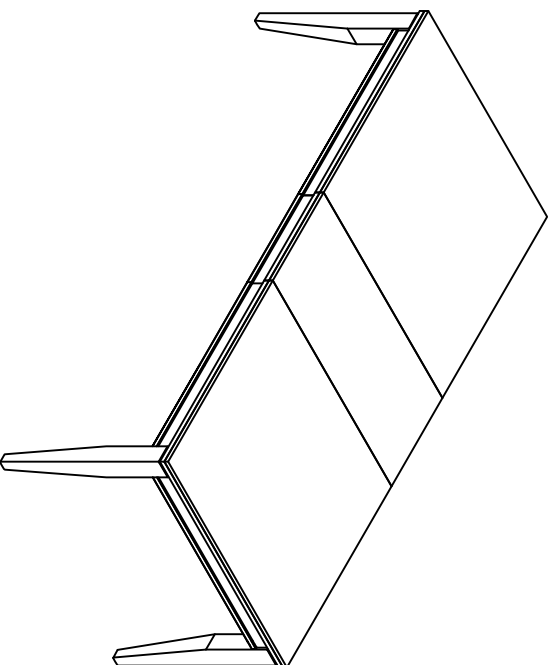

(1)



- x8 Nuts Ø5/16"x1.3x8mm*
- x8 Ecrou Ø5/16"x1.3x8mm
- x8 Tuerca Ø5/16"x1.3x8mm

(2)



- x8 Lock washer Ø5/16"
- x8 Rondelle de blocage Ø5/16"
- x8 Arandela de Seguridad Ø5/16"

(3)



- x8 Flat Washer Ø5/16"x19x1.5mm*
- x8 Rondelle plate Ø5/16"x19x1.5mm
- x8 Arandela plana Ø5/16"x19x1.5mm

(4)



- x1 Hex Wrench *
- x1 Clé hexagonale
- x1 Llave hexagonal

* Replaceable Part

HIF HOOKER FURNISHINGS

ASSEMBLY INSTRUCTIONS / NOTICE DE MONTAGE / INSTRUCCIONES DE MONTAJE
 ITEM / NO D' ARTICLE / ARTICULO : S916-135
 DESCRIPTION / DESCRIPCIÓN: Leg Table / Patte de table/ Pata de mesa

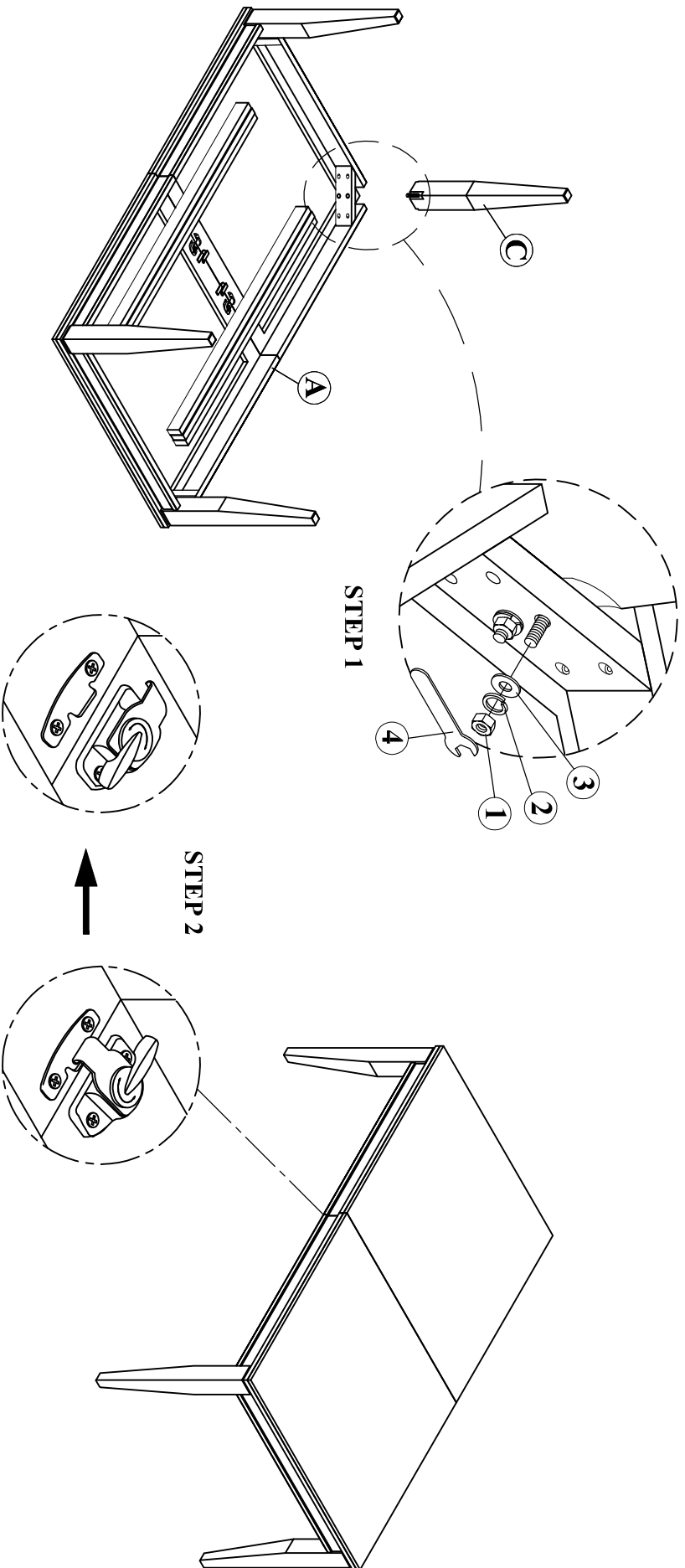

TABLE LOCK
Open position

TABLE LOCK
Closed position

** Replaceable Part*

HIF | HOOKER FURNISHINGS

ASSEMBLY INSTRUCTIONS / NOTICE DE MONTAGE / INSTRUCCIONES DE MONTAJE
ITEM / NO D' ARTICLE / ARTICULO : S916-135
DESCRIPTION / DESCRIPCIÓN: Leg Table / Patte de table/ Pata de mesa

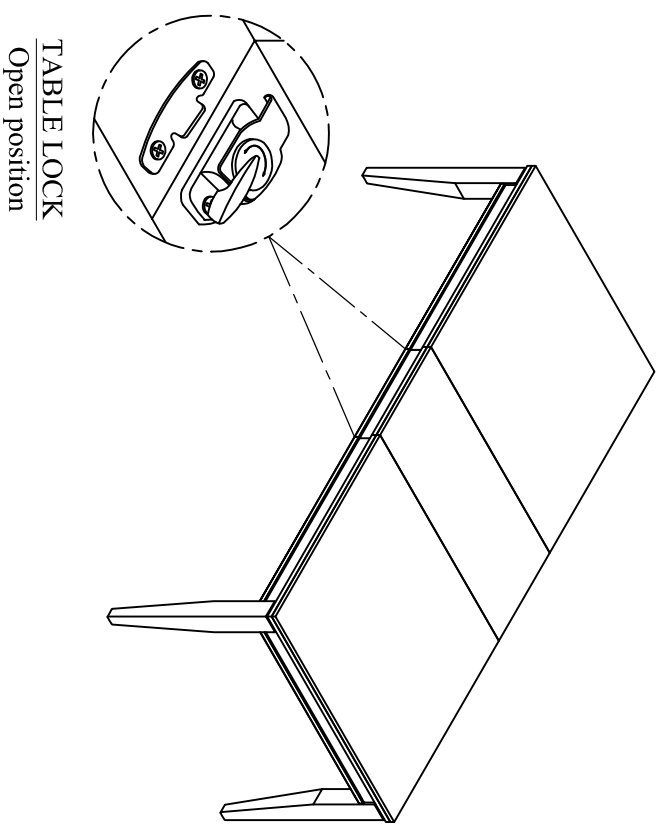
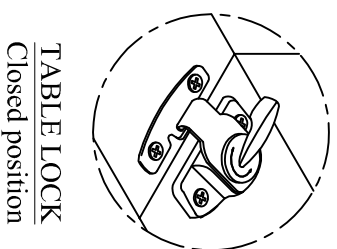
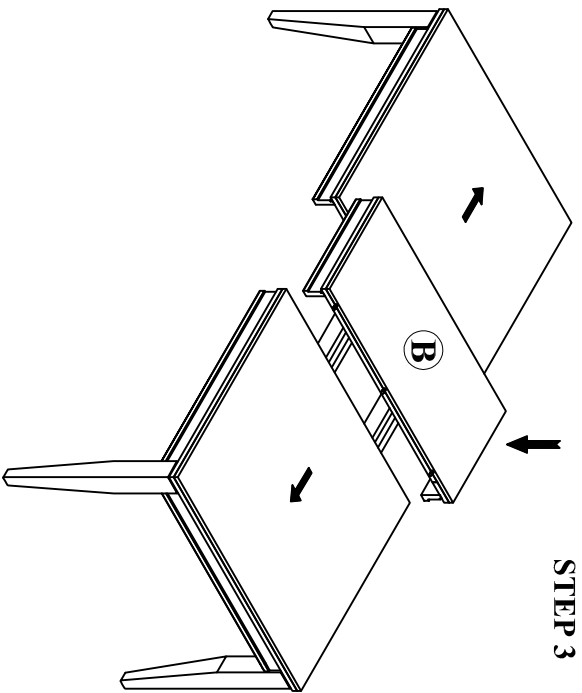

** Replaceable Part*

HIF | HOOKER FURNISHINGS

REPLACEABLE PART / PARTIE REMPLAÇABLE / PARTE REEMPLAZABLE
ITEM / NO D' ARTICLE / ARTICULO : S916-135
DESCRIPTION / DESCRIPCIÓN: Leg Table / Patte de table/ Pata de mesa

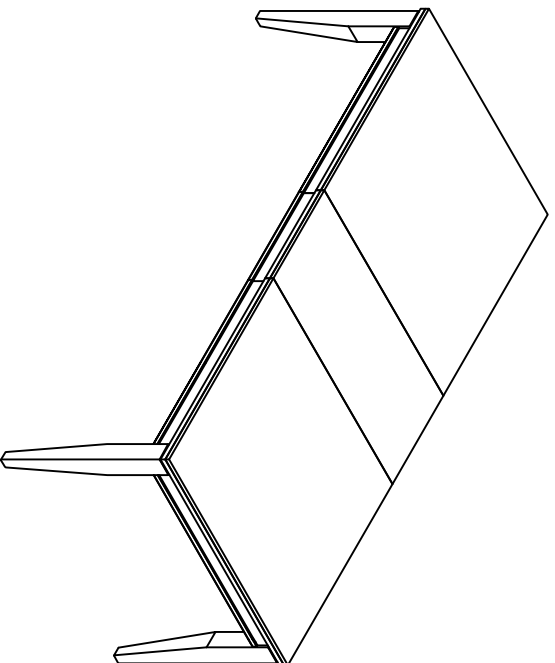

x4 RS916-135 LEG- Leg
jambé
Pierna



x1 RS916-135 HWKIT-Hardware kit list
Liste des pièces de quincaillerie
Lista del kit de materiales

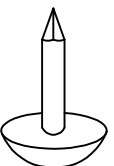

x4 RC-WH-NAIL - White plastic nail
Clou en plastique
Clavo de plástico

** Replaceable Part*

Protect Your Wood or Laminate Flooring

*This statement applies to any floor without carpet.

If not careful, all furniture including upholstery and case pieces can scratch, scuff and even gouge floors. The recommendation is to have felt, rubber pads or area rugs under furniture on flooring without carpet.

Moving your furniture

Pushing and dragging furniture over floors without carpet can lead to scratches and scuffs. Have someone help when moving the larger pieces of furniture by lifting, try using a dolly or moving pads.

Felt and rubber pads

Applying furniture pads to the feet of furniture helps cushion contact points. Furniture pads can be found at local hardware stores. Felt pads slide easily across the floor, making them ideal for dining chairs and other pieces that move with use. Rubber pads will help furniture stay in place and are perfect for larger pieces, like sofas and loveseats.

Area rugs and rug pads

Using an area rug under furniture is another way to protect your floor from scratches and scuff marks. A rug pad under the area rug will provide extra cushion and added protection.