

<b>WARNING</b>	
<p>Children have died from furniture tipover. To reduce the risk of furniture tipover:</p> <ul style="list-style-type: none"> <li>· ALWAYS install Anti-tip device provided.</li> <li>· NEVER put a TV on this product.</li> <li>· NEVER allow children to stand, climb or hang on any drawers, doors, or shelves.</li> <li>· NEVER open more than one drawer at a time.</li> <li>· PLACE heaviest items in the lowest drawers. This is a permanent label. Do not remove !</li> </ul>	

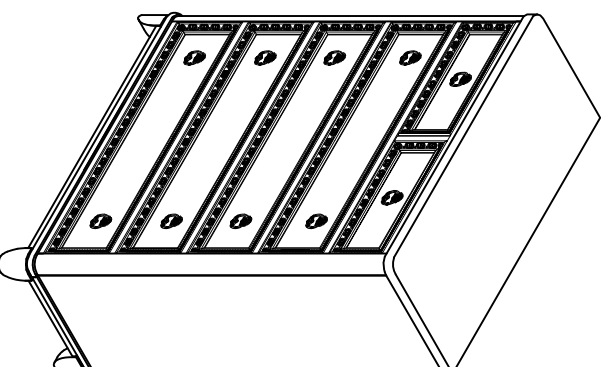

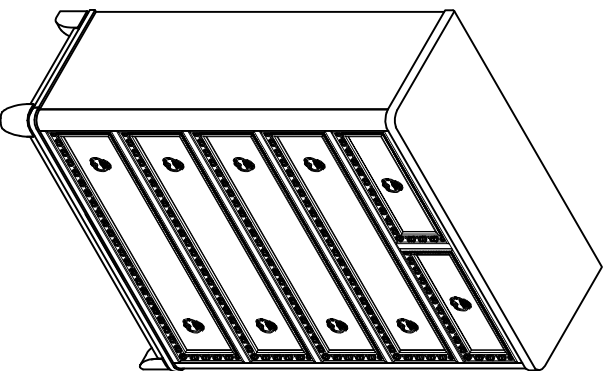

- x1 Drawer Chest
- x1 Commode à tiroirs
- x1 Còmoda

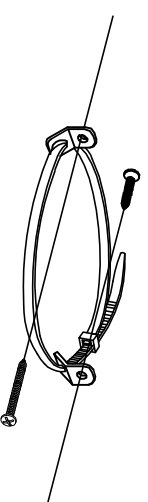

- x1 Furniture Tipping Restraint\*
- x1 Systeme antibasculement
- x1 Control para evitar vuelcos

\* *Replaceable Part*

	<b>WARNING</b>
	<p>Children have died from furniture tipover. To reduce the risk of furniture tipover:</p> <ul style="list-style-type: none"><li>· ALWAYS install Anti-tip device provided.</li><li>· NEVER put a TV on this product.</li><li>· NEVER allow children to stand, climb or hang on any drawers, doors, or shelves.</li><li>· NEVER open more than one drawer at a time.</li><li>· PLACE heaviest items in the lowest drawers. This is a permanent label. Do not remove !</li></ul>

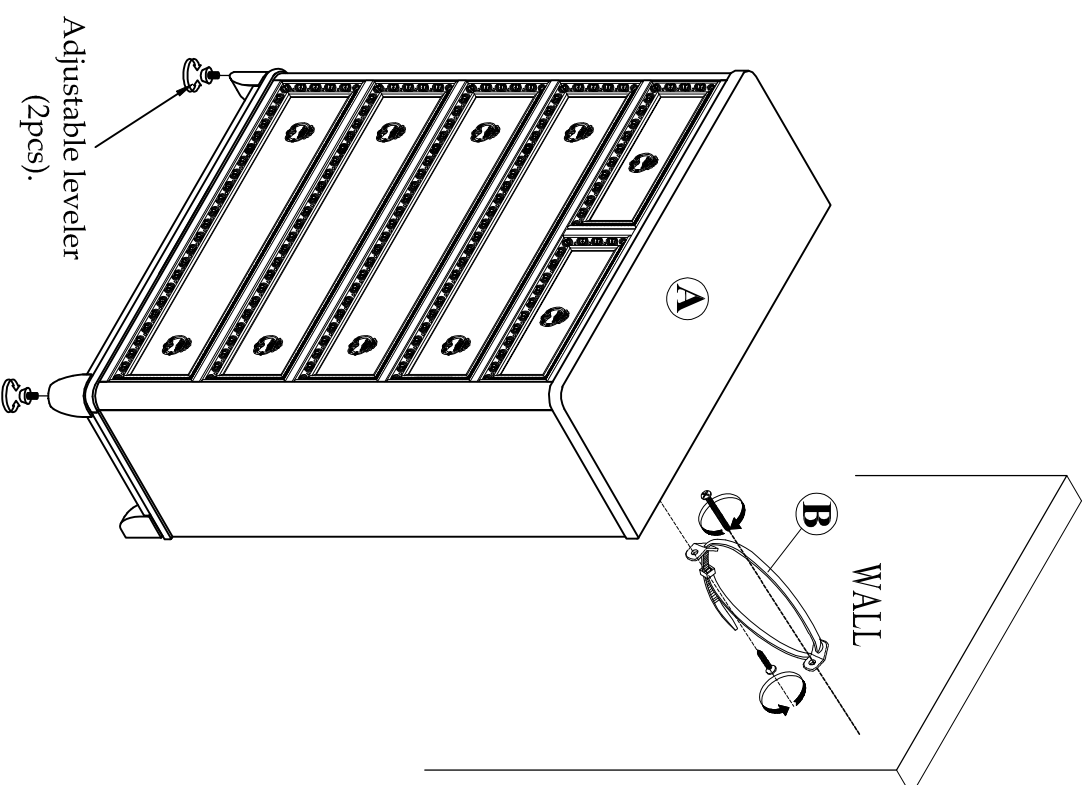

*\*Replaceable Part*

# HIF HOOKER

**REPLACEABLE PART / PARTIE REMPLAÇABLE / PARTE REMPLAZABLE**  
 ITEM / NO D' ARTICLE / ARTICULO : S884-040  
 DESCRIPTION / DESCRIPTION: DRAWER CHEST / COMMUNE À TIROIRS / CÒMODA

## WARNING



Children have died from furniture tipover. To reduce the risk of furniture tipover:

- ALWAYS install Anti-tip device provided.
- NEVER put a TV on this product.
- NEVER allow children to stand, climb or hang on any drawers, doors, or shelves.
- NEVER open more than one drawer at a time.
- PLACE heaviest items in the lowest drawers.



This is a permanent label. Do not remove !

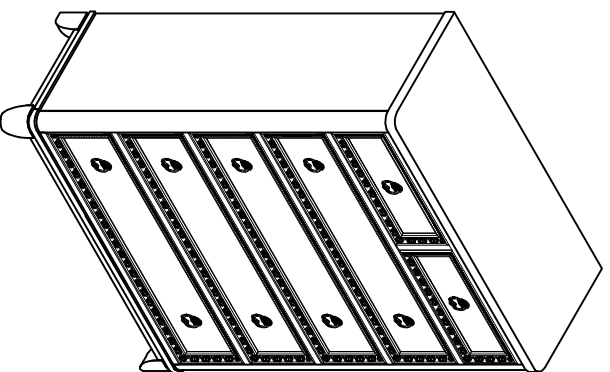

x10 RSS884-010-PULL- Pull with Screw \*  
 Poignée + vis  
 Tirador + Tornillo



x5 COMGLIDE-10-45-Common Glide 10in-45mm \*  
 Tiroir Glide  
 Deslizamiento del cajón



x1 RC-ANTI-TIP-Anti-tipping Restraint  
 Liste des pièces de quincaillerie antibasculement  
 Lista del kit de materiales antivuelco

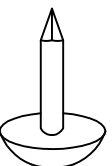

x2 RC-WH-NAIL-White plastic nail  
 Clou en plastique  
 Clavo de plástico

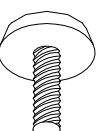

x2 RC-FG-WHITE- White leveler  
 Patin réglable  
 Nivelador ajustable

*\* Replaceable Part*

## **Protect Your Wood or Laminate Flooring**

\*This statement applies to any floor without carpet.

If not careful, all furniture including upholstery and case pieces can scratch, scuff and even gouge floors. The recommendation is to have felt, rubber pads or area rugs under furniture on flooring without carpet.

### **Moving your furniture**

Pushing and dragging furniture over floors without carpet can lead to scratches and scuffs. Have someone help when moving the larger pieces of furniture by lifting, try using a dolly or moving pads.

### **Felt and rubber pads**

Applying furniture pads to the feet of furniture helps cushion contact points. Furniture pads can be found at local hardware stores. Felt pads slide easily across the floor, making them ideal for dining chairs and other pieces that move with use. Rubber pads will help furniture stay in place and are perfect for larger pieces, like sofas and loveseats.

### **Area rugs and rug pads**

Using an area rug under furniture is another way to protect your floor from scratches and scuff marks. A rug pad under the area rug will provide extra cushion and added protection.