

**PARTS LIST / LISTE DES PIÈCES / LISTA DE PIEZAS**

**ITEM NO./NO D'ARTICLE./ARTICULO NO:** DS-D030003-501/602

**DESCRIPTION/ LA DESCRIPTION/ DESCRIPCIÓN:** Wood Frame Accent Chair - Dark Green / Navy /  
Fauteuil décoratifs / Silla decorativa

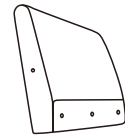

**A**

x1 Chair Back  
x1 Dossier de chaise  
x1 Respaldo de silla

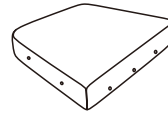

**B**

x1 Chair Seat  
x1 Siège de chaise  
x1 Asiento de silla

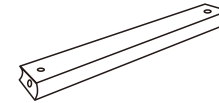

**C**

x1 Front stretcher\*  
x1 Barreau avant  
x1 Travesaño delantero

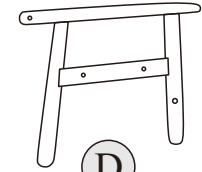

**D**

x1 Left Arm\*  
x1 Accoudoir gauche  
x1 Brazo izquierdo

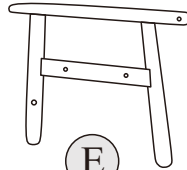

**E**

x1 Right Arm\*  
x1 Accoudoir droit  
x1 Brazo derecho



**F**

x9 Allen bolt (M6 x 50mm)\*  
x9 Vis à tête creuse hexagonale (M6 x 50mm)  
x9 Perno Allen (M6 x 50mm)

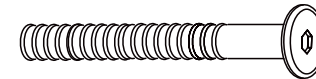

**G**

x2 Allen bolt (M6 x 80mm)\*  
x2 Vis à tête creuse hexagonale (M6 x 80mm)  
x2 Perno Allen (M6 x 80mm)

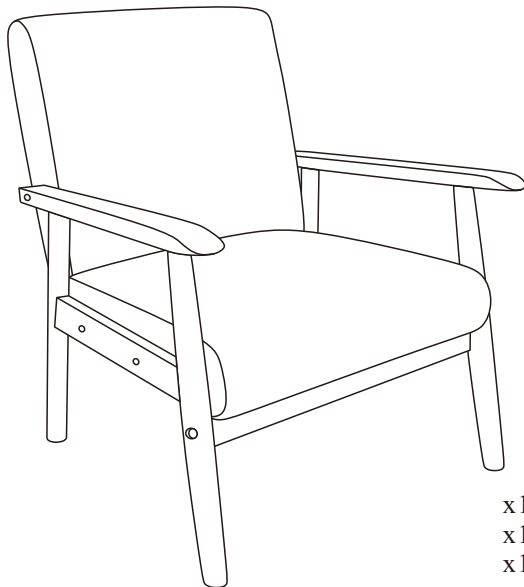

**H**

x11 Spring Washer M6\*  
x11 Rondelle à ressort M6  
x11 Arandela auto-bloquante M6

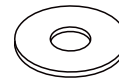

**I**

x3 Flat Washer M6\*  
x3 Rondelle Plate M6  
x3 Arandela Plana M6



**J**

x1 Allen Wrench\*  
x1 Clé Hexagonale  
x1 Llave Allen

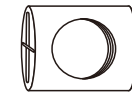

**K**

x2 Nut\*  
x2 Écrou  
x2 Tuercas



**L**

x8 Wooden Button Ø14mm\*  
x8 Bouton en bois Ø14mm  
x8 Botón de madera Ø14mm

*\*Replaceable Part*

ASSEMBLY INSTRUCTIONS/ NOTICE DE MONTAGE/ INSTRUCCIONES DE MONTAJE

ITEM NO./NO D'ARTICLE./ARTICULO NO: DS-D030003-501/602

DESCRIPTION/ LA DESCRIPTION/ DESCRIPCIÓN: Wood Frame Accent Chair - Dark Green / Navy /  
Fauteuil décoratifs / Silla decorativa

STEP 1

ÉTAPE 1

PASO 1

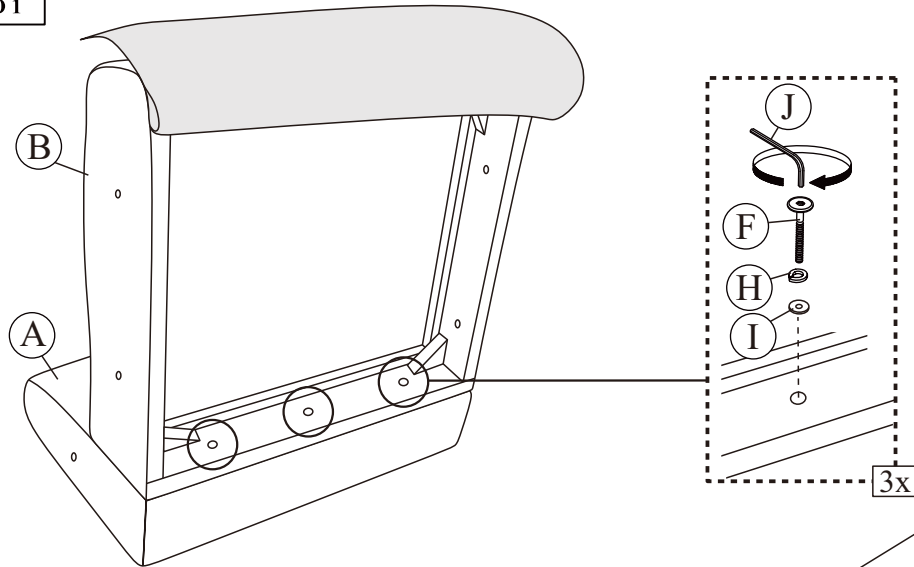

STEP 2

ÉTAPE 2

PASO 2

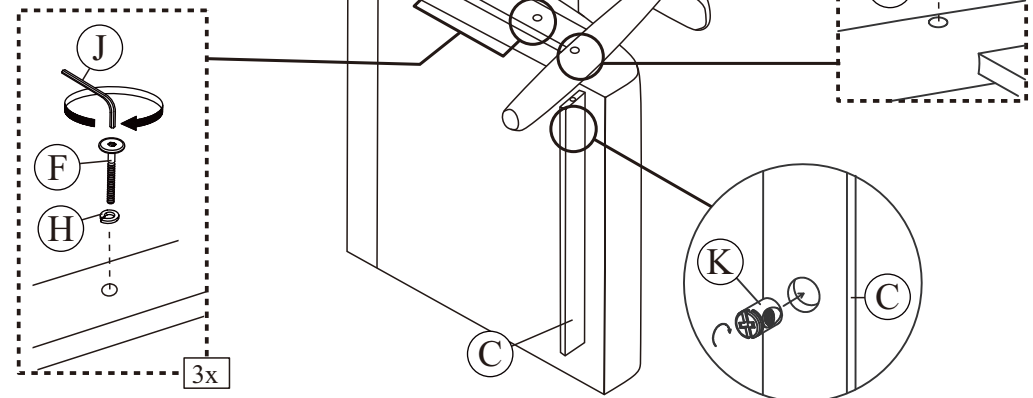

ASSEMBLY INSTRUCTIONS/ NOTICE DE MONTAGE/ INSTRUCCIONES DE MONTAJE

ITEM NO./NO D'ARTICLE./ARTICULO NO: DS-D030003-501/602

DESCRIPTION/ LA DESCRIPTION/ DESCRIPCIÓN: Wood Frame Accent Chair - Dark Green / Navy /  
Fauteuil décoratifs / Silla decorativa

STEP 3

ÉTAPE 3

PASO 3

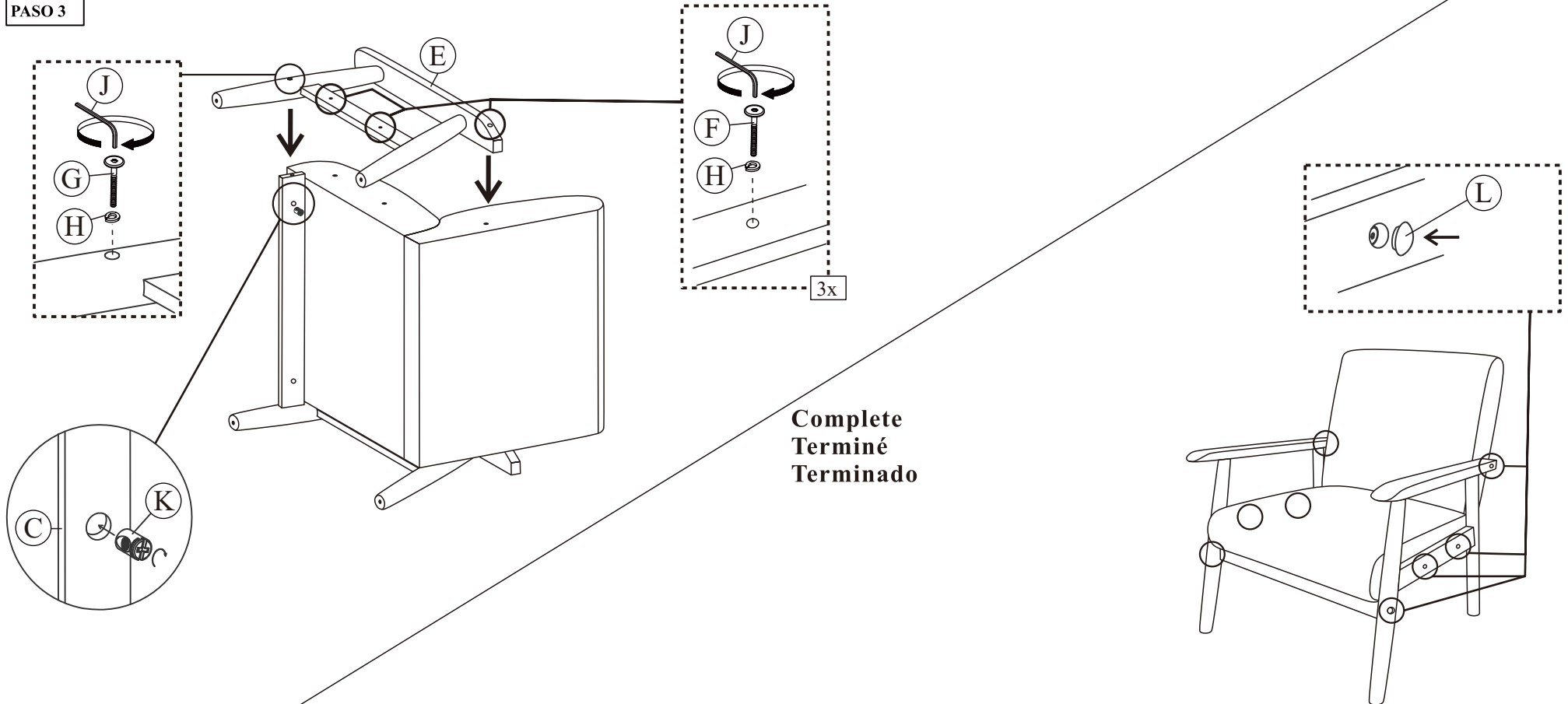

Complete  
Terminé  
Terminado

Important Note: Part L (Flat-bottomed Wooden Screw Cap Covers) are optional. If installed, they should be placed over exposed screw hole wells, covered with a cloth to protect chair paint/finish during installation, and gently hammered into place with a rubber mallet.

Remarque importante: la partie L (couvercles à vis en bois à fond plat) est facultative. S'ils sont installés, ils doivent être placés sur les puits de trous de vis exposés, recouverts d'un chiffon pour protéger la peinture / finition de la chaise pendant l'installation, et martelés doucement en place avec un maillet en caoutchouc.

Nota importante: la parte L (tapas de madera con tapa de rosca de fondo plano) es opcional. Si están instalados, deben colocarse sobre los orificios de los tornillos expuestos, cubrirse con un paño para proteger la pintura / el acabado de la silla durante la instalación y martillarse suavemente en su lugar con un mazo de goma.

REPLACEABLE PART / PARTIE REMPLAÇABLE / PARTE REEMPLAZABLE

ITEM NO./NO D'ARTICLE./ARTICULO NO: DS-D030003-501/602

DESCRIPTION/ LA DESCRIPTION/ DESCRIPCIÓN: Wood Frame Accent Chair - Dark Green / Navy /  
Fauteuil décoratifs / Silla decorativa

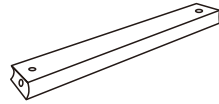
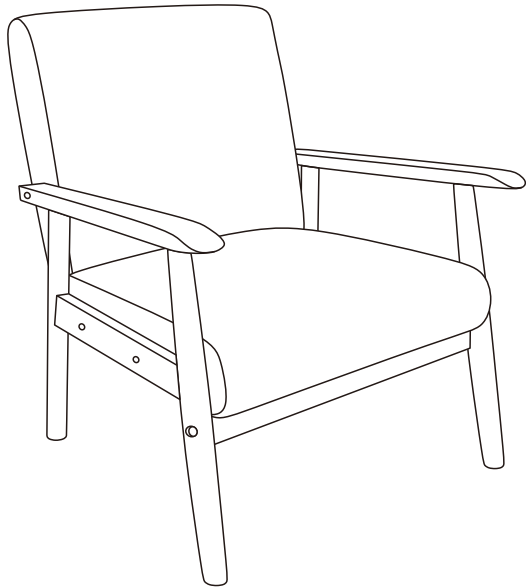

x1 RD030003-501-STRE\*  
Front stretcher  
Barreau avant  
Travesaño delantero

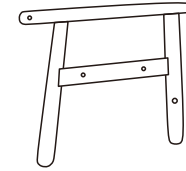

x1 RD030003-501-ARML\*  
Left Arm  
Accoudoir gauche  
Brazo izquierdo

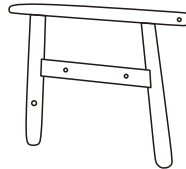

x1 RD030003-501-ARMR\*  
Right Arm  
Accoudoir droit  
Brazo derecho

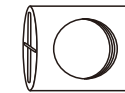

x2 RD030003-501-NUT\*  
Nut  
Écrou  
Tuercas

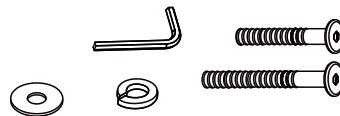

x1 RD030003-501-HWKI\*  
Hardware Kit  
Liste Des Pièces De quincaillerie  
Lista del kit de materiales



x8 RD030003-501-CAP\*  
Wooden Button Ø14mm  
Bouton en bois Ø14mm  
Botón de madera Ø14mm

*\*Replaceable Part*

## **Protect Your Wood or Laminate Flooring**

\*This statement applies to any floor without carpet.

If not careful, all furniture including upholstery and case pieces can scratch, scuff and even gouge floors. The recommendation is to have felt, rubber pads or area rugs under furniture on flooring without carpet.

### **Moving your furniture**

Pushing and dragging furniture over floors without carpet can lead to scratches and scuffs. Have someone help when moving the larger pieces of furniture by lifting, try using a dolly or moving pads.

### **Felt and rubber pads**

Applying furniture pads to the feet of furniture helps cushion contact points. Furniture pads can be found at local hardware stores. Felt pads slide easily across the floor, making them ideal for dining chairs and other pieces that move with use. Rubber pads will help furniture stay in place and are perfect for larger pieces, like sofas and loveseats.

### **Area rugs and rug pads**

Using an area rug under furniture is another way to protect your floor from scratches and scuff marks. A rug pad under the area rug will provide extra cushion and added protection.