

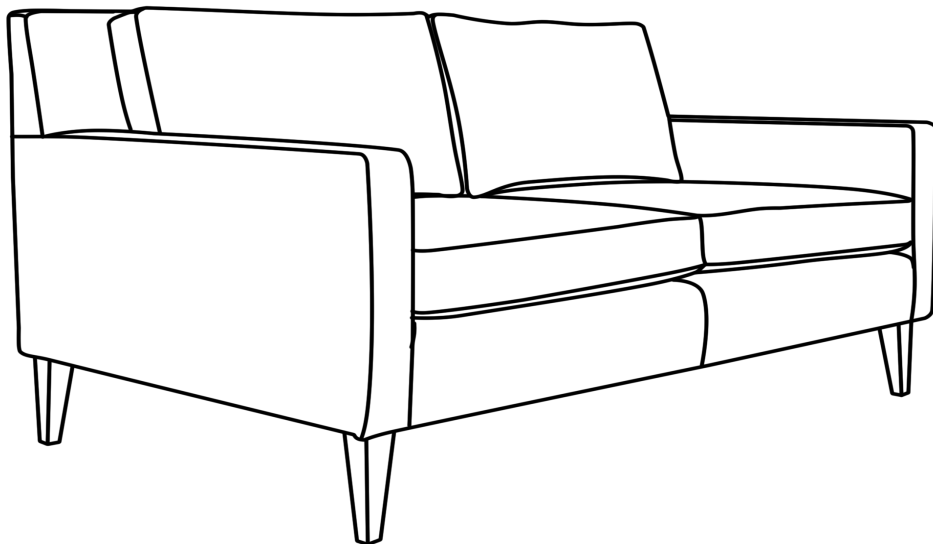



Luna Loveseat

Luna Loveseat



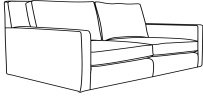

ASSEMBLY INSTRUCTIONS



PARTS LIST

LABLE	PICTURE	DESCRIPTION	QTY
A		Loveseat Body	1
B		Legs	4

HARDWARE

LABLE	PICTURE	DESCRIPTION	QTY
C		Screw(M6*30)	12
D		Spring Washer	12
E		Metal Gasket	12
F		Wrench	1

BEFORE BEGINNING ASSEMBLY:



Read instructions cover to cover



Have two adults on hand for assembly



DO NOT assemble on flooring or carpet. Assemble on a clean non-marring surface(ex: packing foam)



Save all packaging until assembly is completed

ASSEMBLY STEPS

STEP 1

Please open the zipper underneath chair and there are the legs and hardware pack

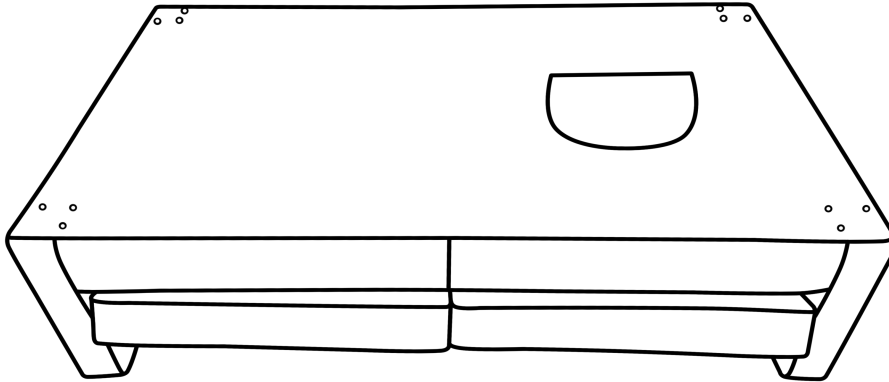
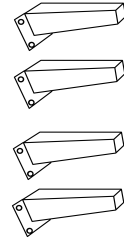

- › Position the product on its bottom as shown.
- › Open to take the four legs.

STEP 2

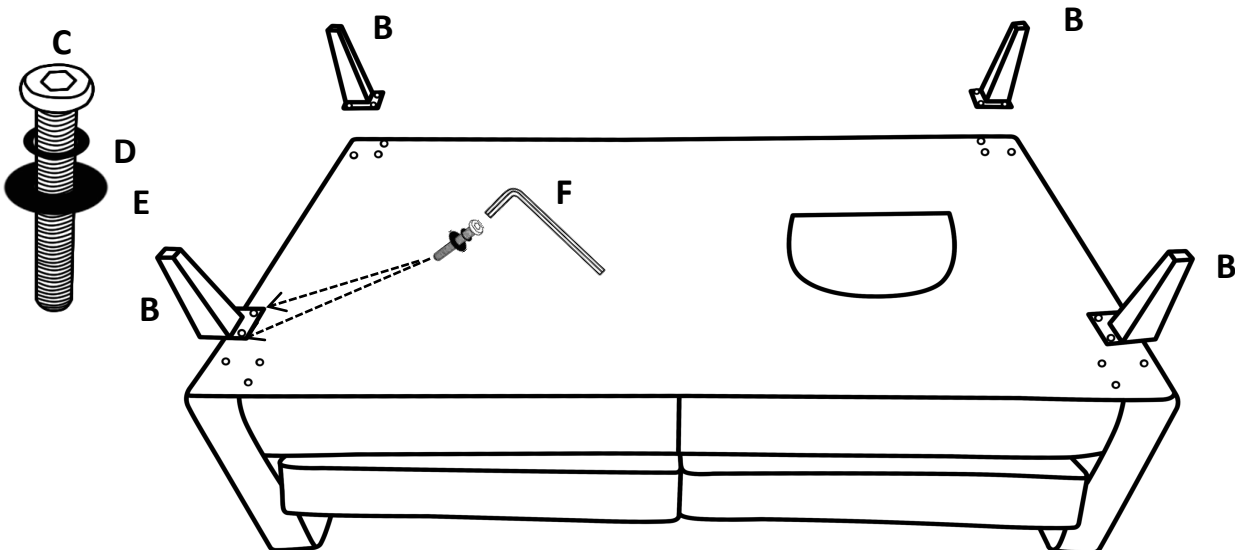

- › Attach the four legs into the Loveseat body, and tighten all screws. Assembly is completed.

CARE & MAINTENANCE



Do not put hot items directly on furniture surface



Do not clean furniture with harsh cleansers or polish.



Dust and pick up spills using a clean, non-colored, lint-free cloth.



Stains may be removed with a mild soap solution and a damp cloth.



Do not place furniture under direct sunlight.



Do not place furniture near heating or cooling vents.



Do not write on furniture without a padded barrier to protect the surface.



Do not place furniture outside, for indoor use only.