











## IMPORTANT NOTE :

- Place all wooden parts on a clean and smooth surface such as a rug or carpet to avoid the parts from being scratched.
- Check to be sure that you have all parts and hardware.
- Remove all wrapping materials, including staples & packing straps before you start to assemble.
- Do not tighten all screws / bolts until all completely assembled.
- Keep all hardware parts out of reach of children.

PART LIST			
NO	DESCRIPTION		QTY/PCS
1		TABLE TOP	1 PC
2		CENTER SUPPORT	1 PC
3		TABLE LEG	4 PC

PART LIST			
NO	DESCRIPTION		QTY/PCS
A		BOLT M6 x 20MM	4 PC
B		BOLT M6 x 25MM	8 PC
C		ALLEN KEY M4 x 60MM	1 PC
D		SPRING WASHER M6 x 12MM	12 PC
E		FLAT WASHER M6 x 19MM	12 PC
F		LEVELLER	4 PC

## STEP 1

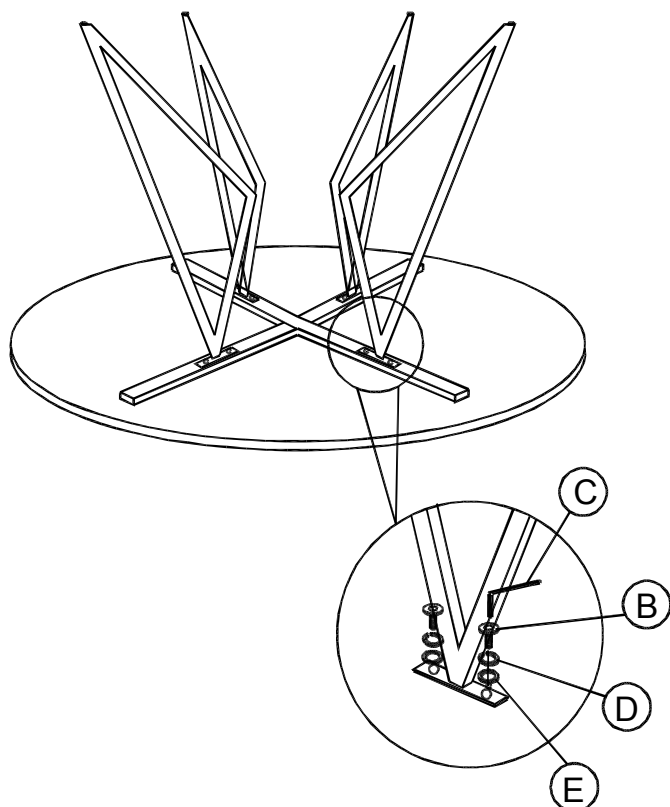

## STEP 2

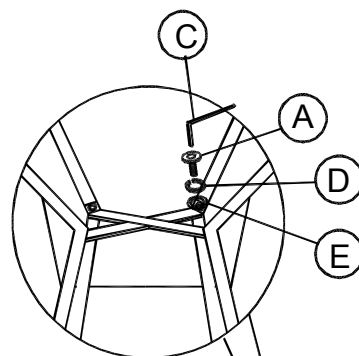

## STEP 3

