

ASSEMBLY INSTRUCTIONS

T127-01 COCKTAIL TABLE

Read Instructions carefully prior to assembly.

Thank you for purchasing this high quality product. Check carefully for small parts which may have come loose during shipment.

Diagram1

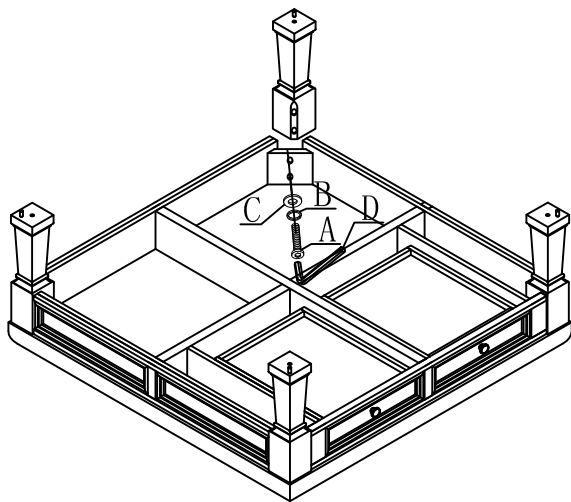
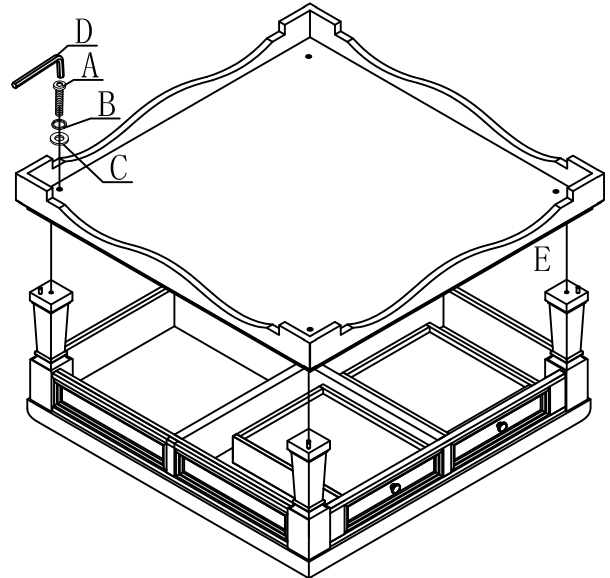
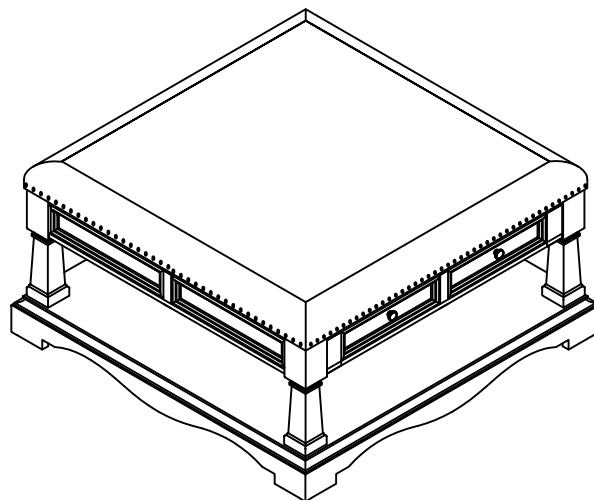





Diagram2



Begin by placing the table upside down on a smooth surface please make sure the surface is not abrasive.



HARDWARE LIST

NO.	SKETCH	HARDWARE	Q' TY	NO.	SKETCH	HARDWARE	Q' TY
A		1/4"*2" ALLEN BOLT	12	B		ø1/4" LOCK WASHER	12
C		ø1/4" FLAT WASHER	12	D		4mm ALLEN WRENCH	1