

# ASSEMBLY INSTRUCTION

Item No: D878-64 / D879-64

Description: COUNTER STOOL

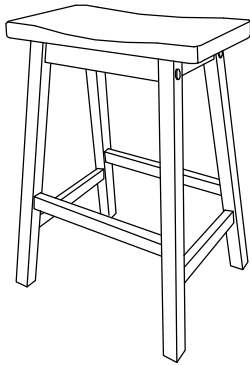







## IMPORTANT NOTE :

- Place all wooden parts on a clean and smooth surface such as a rug or carpet to avoid the parts from being scratched.
- Check to be sure that you have all parts and hardware.
- Remove all wrapping materials, including staples & packing straps before you start to assemble.
- Do not tighten all screws/bolts until all completely assembled.
- Keep all hardware parts out of reach of children.

*Each chair*

PARTS LIST		
NO.	DESCRIPTION	QTY.
1	LEG MEMBER	2 PCS
2	WOODEN SEAT	1 PC
3	SHORT STRETCHER	2 PCS
4	LONG STRETCHER	2 PCS

HARDWARE LIST		
NO.	DESCRIPTION	QTY.
A	ALLEN KEY M4 X 63 MM 	1 PC
B	JCBC/W SCREW M7 X 50 MM 	4 PCS
C	PH CBS #8 1 1/2 	4 PCS
D	PH CBS #8 1 1/4 	4 PCS
E	DOWEL PINS M8 X 30MM 	2 PCS
F	WOOD BUTTON Ø14.5 X 9MM 	4 PCS

## STEP 1

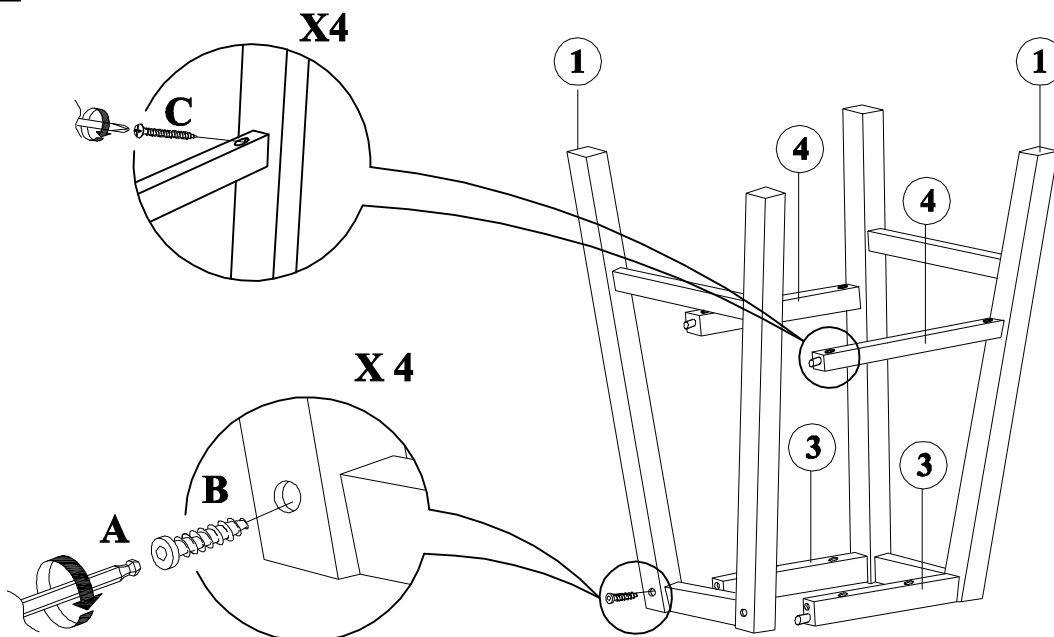

**STEP 2**

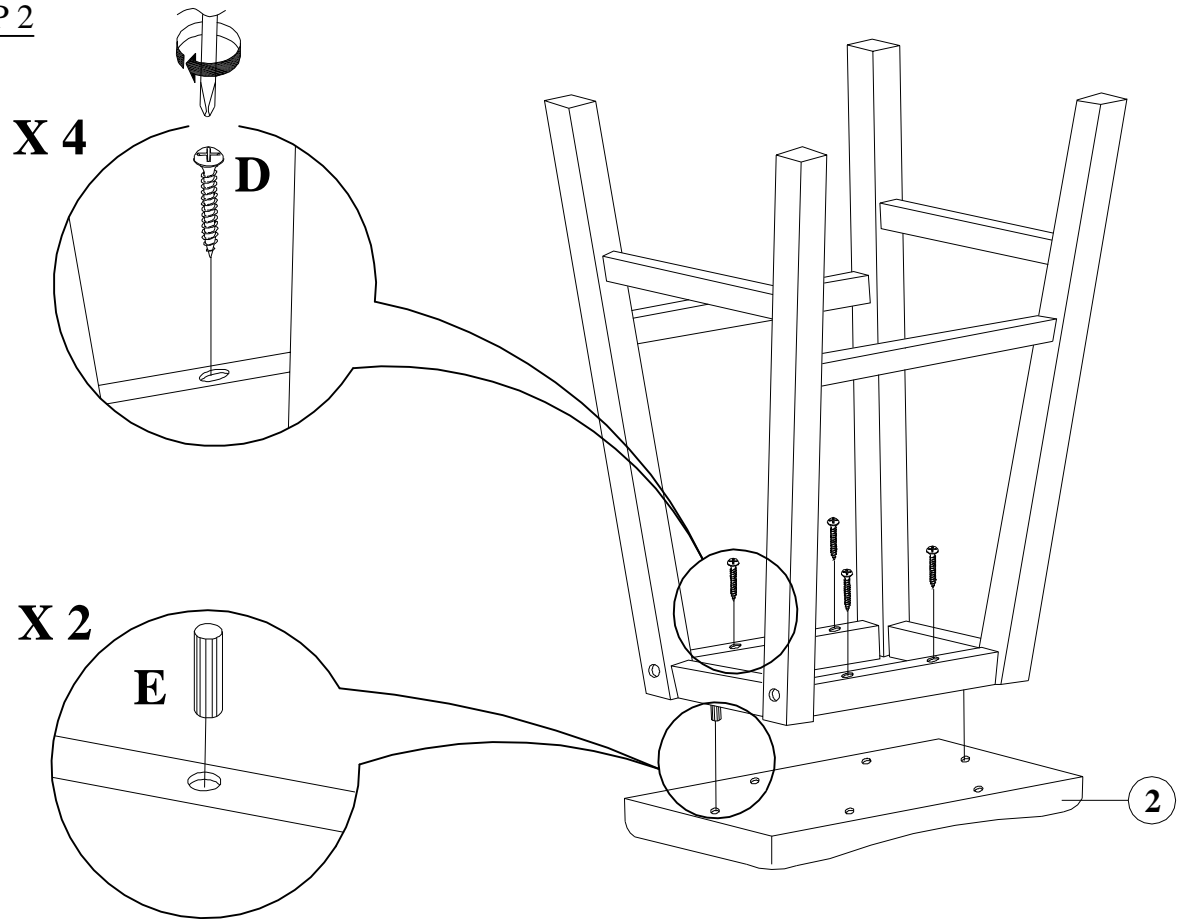

**STEP 3**

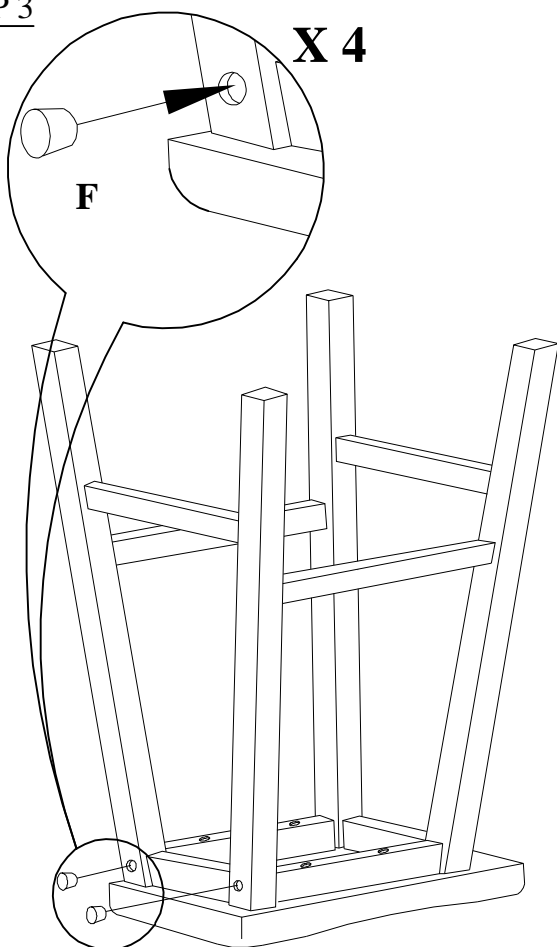

**STEP 4**

