

**MODEL : B117-94 /
B117-34**

REVISION : A

ASSEMBLY TIPS :

1. Remove hardware from box and sort by size.
2. Please check to see that all hardware and parts are present prior to start of assembly.
3. Please follow attached instructions in the same sequence as numbered to assure fast and easy assembly.







Component List

Box Of Headboard

No	Descriptions	Qty
A	Headboard	1
B	Headboard Leg (Left)	1
C	Headboard Leg (Right)	1

Box Of Headboard

Hardware List

No	Descriptions	Qty
1	JCBC Screw M6 x 30mm 	6
2	Spring Washer Ø 1/4" 	6
3	Flat Washer Ø 1/4" x 13mm 	6
4	L Key M5 	1
5	LED Adaptor 	1
6	Touch Lighting Unit (attach on HB) 	1

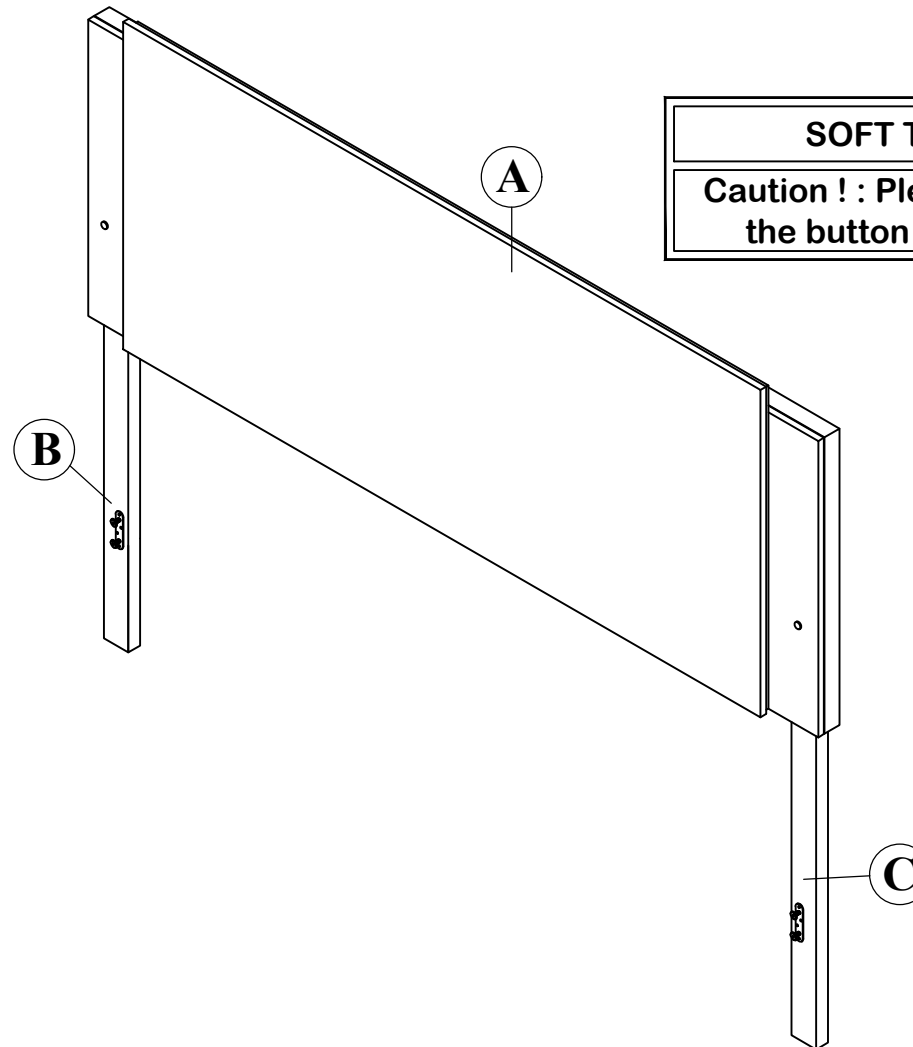

SOFT TOUCH LED

**Caution ! : Please do not touch
the button with wet hand.**

