

## PARTS LIST / LISTE DES PIÈCES / LISTA DE PIEZAS

ITEM NO./ NO D'ARTICLE / ARTICULO NO. : P378240/241

DESCRIPTION/ LA DESCRIPTION / DESCRIPCIÓN : Trestle Table Base / Base de table à tréteaux / Base de mesa de caballete  
: Trestle Table Top / Dessus de table à tréteaux / Tablero de mesa de caballete

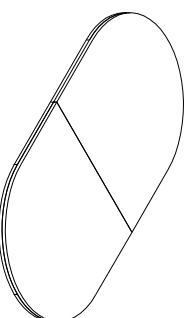
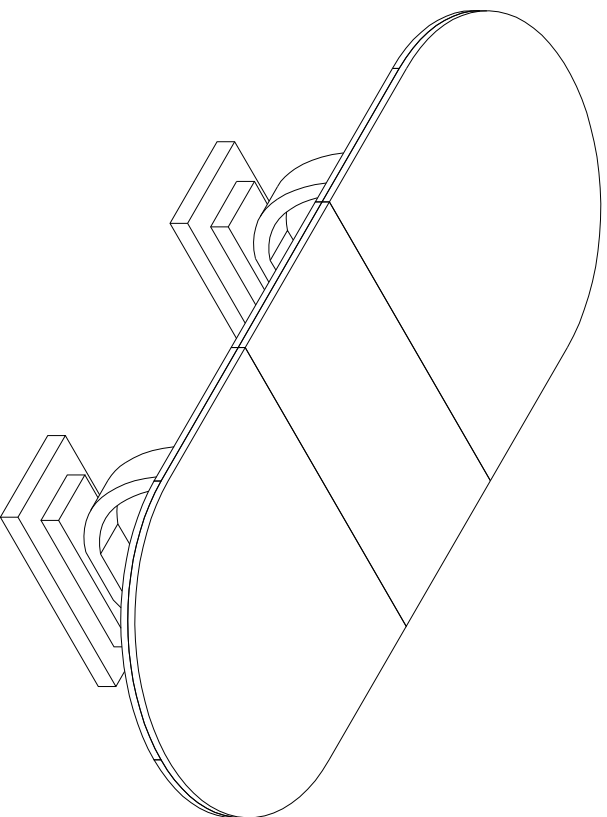

**(A)**

x1 Table Top  
x1 Dessus de table  
x1 Tablero de mesa

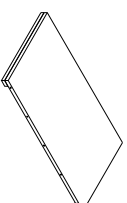

**(B)**

x1 Table Leaf  
x1 Panneau de table  
x1 Extension

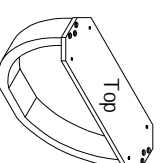

**(C)**

x2 Post Leg  
x2 Post Jambes  
x2 Post Piernas

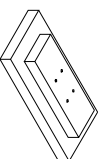

**(D)**

x2 Table base  
x2 Base de table  
x2 Base de mesa



**(E)**

x16 Flat Washer  $\phi 5/16"$  x1 9x2mm \*  
x16 Rondelle plate  $\phi 5/16"$  x1 9x2mm  
x16 Arandela plana  $\phi 5/16"$  x1 9x2mm



**(F)**

x16 Lock washer  $\phi 5/16"$  \*  
x16 Rondelle de blocage  $\phi 5/16"$   
x16 Arandela de Seguridad  $\phi 5/16"$

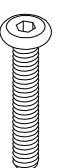

**(G)**

x8 Allen bolt  $\phi 5/16"$  x51mm \*  
x8 Vis à tête creuse hexagonale  $\phi 5/16"$  x51mm  
x8 Perno Allen  $\phi 5/16"$  x51mm

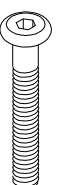

**(H)**

x8 Allen bolt  $\phi 5/16"$  x114mm \*  
x8 Vis à tête creuse hexagonale  $\phi 5/16"$  x114mm  
x8 Perno Allen  $\phi 5/16"$  x114mm

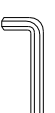

**(I)**

x1 Allen Key 5mm \*  
x1 Clé hexagonale 5mm  
x1 Llave Allen 5mm

\* Replaceable Part

## ASSEMBLY INSTRUCTIONS/ NOTICE DE MONTAGE/ INSTRUCCIONES DE MONTAJE

ITEM NO./ NO D'ARTICLE/ ARTICULO NO. : P378240/241

DESCRIPTION/ LA DESCRIPTION /DESCRIPCION : Trestle Table Base / Base de table à tréteaux / Base de mesa de caballete

: Trestle Table Top / Dessus de table à tréteaux / Tablero de mesa de caballete

STEP 1  
ÉTAPE 1  
PASO 1

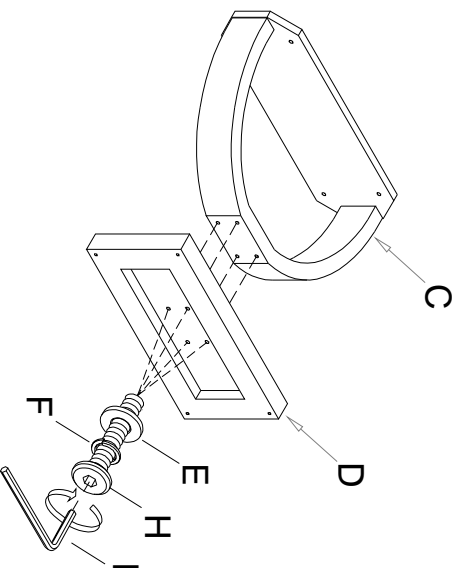

STEP 2  
ÉTAPE 2  
PASO 2

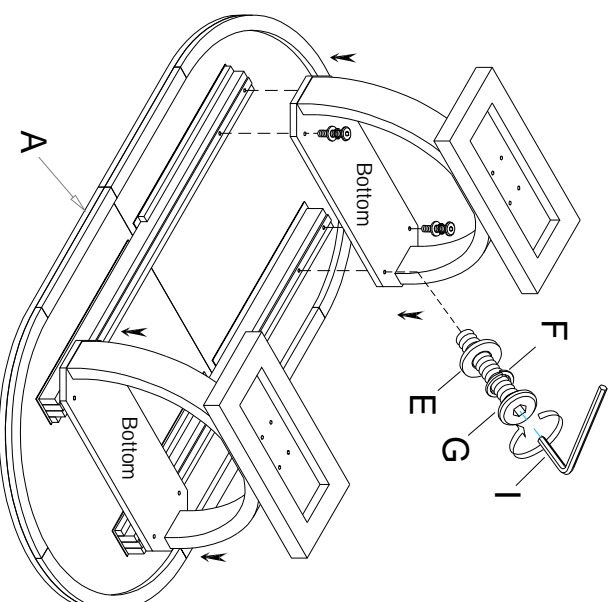

STEP 3  
ÉTAPE 3  
PASO 3

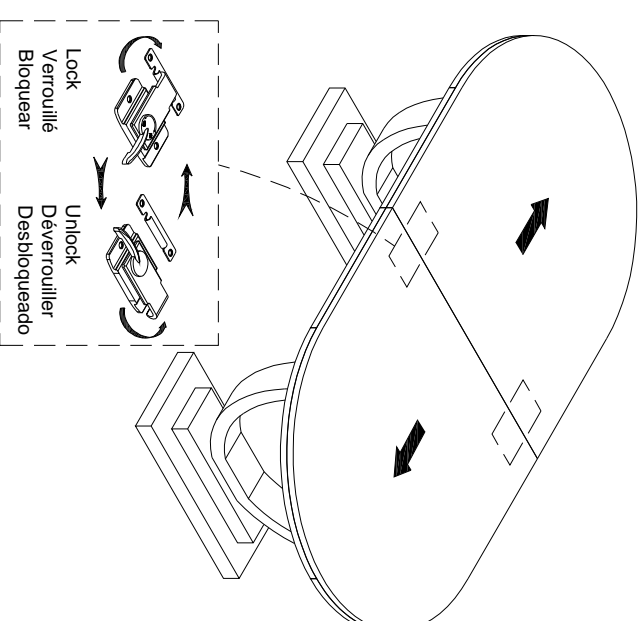

\* Replaceable Part

## ASSEMBLY INSTRUCTIONS/ NOTICE DE MONTAGE/ INSTRUCCIONES DE MONTAJE

ITEM NO./ NO D'ARTICLE/ ARTICULO NO. : P378240/241

DESCRIPTION/ LA DESCRIPTION /DESCRIPCION : Trestle Table Base / Base de table à tréteaux / Base de mesa de caballete

: Trestle Table Top / Dessus de table à tréteaux / Tablero de mesa de caballete

STEP 4  
ÉTAPE 4  
PASO 4

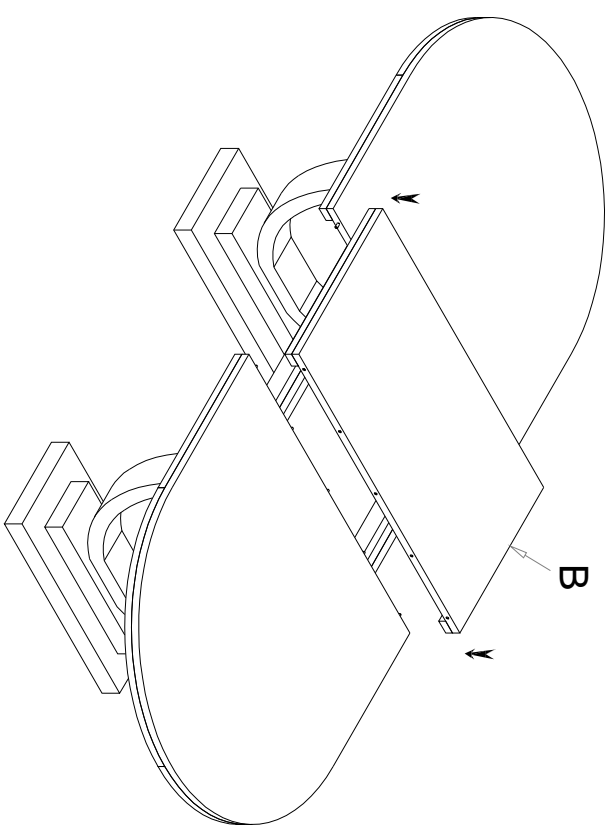

STEP 5  
ÉTAPE 5  
PASO 5

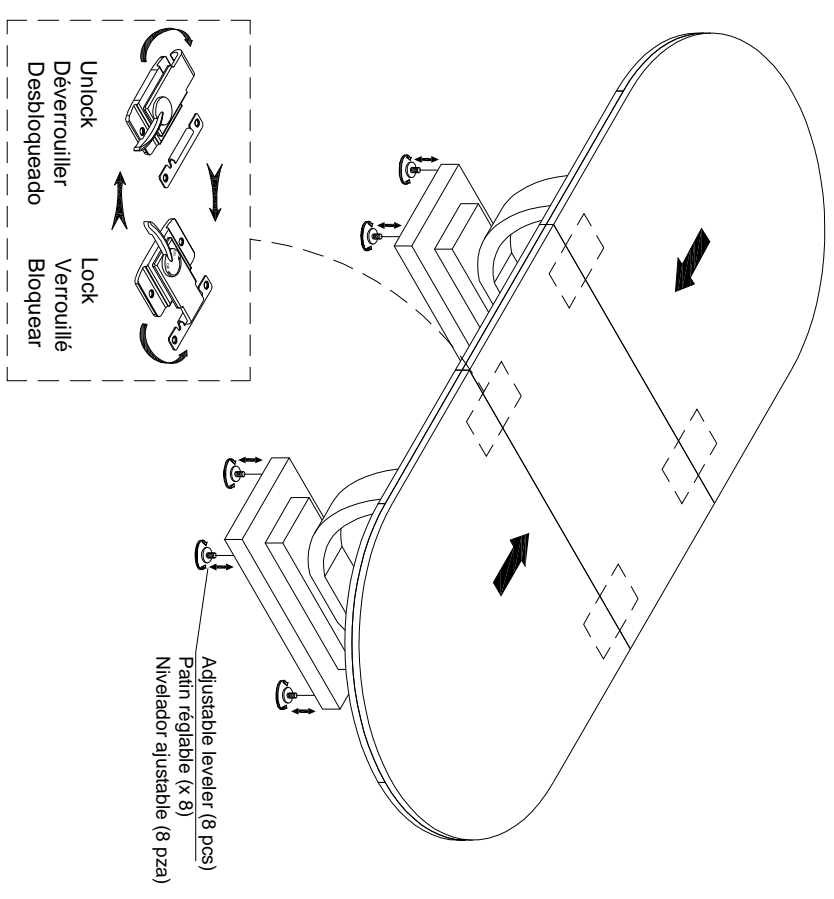

\* Replaceable Part

## REPLACEABLE PART / PARTIE REMPLAÇABLE / PARTE REEMPLAZABLE

ITEM NO. / NO D'ARTICLE / ARTICULO NO. : P378240/241

DESCRIPTION / LA DESCRIPTION / DESCRIPCIÓN : Trestle Table Base / Base de table à tréteaux / Base de mesa de caballete  
: Trestle Table Top / Dessus de table à tréteaux / Tablero de mesa de caballete

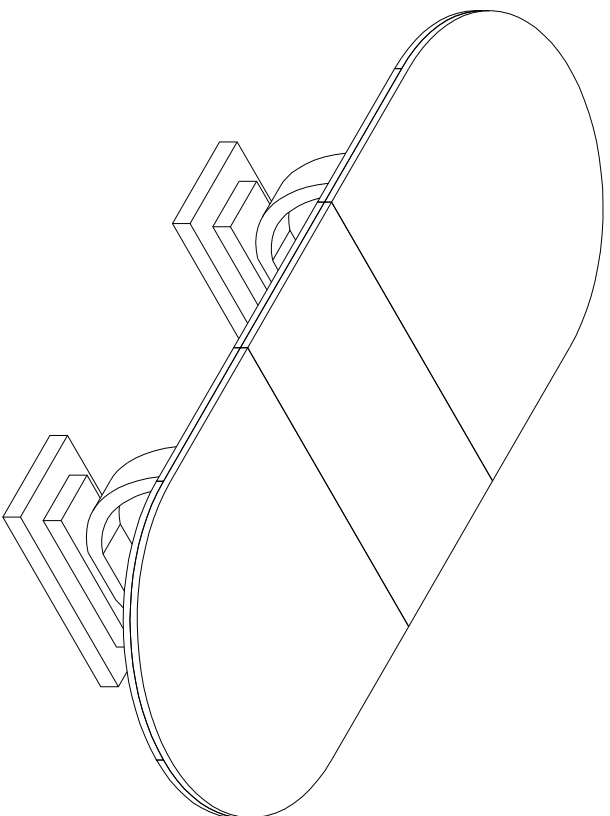

x1 RP378240-HW/KIT -Hardware Kit \*  
Liste des pièces de quincaillerie  
Lista del kit de materiales



x8 RC-FG-WHITE-White Leveler \*  
Patin réglable  
Nivelador



x4 RC-SMV-LOCK-Common SMV Table Lock \*  
Verrouille  
Blouear

\* Replaceable Part

## **Protect Your Wood or Laminate Flooring**

\* This statement applies to any floor without carpet.

If not careful, all furniture including upholstery and case pieces can scratch, scuff and even gouge floors. The recommendation is to have felt, rubber pads or area rugs under furniture on flooring without carpet.

### **Moving your furniture**

Pushing and dragging furniture over floor without carpet can lead to scratches and scuffs. Have someone help when moving the larger pieces of furniture by lifting, try using a dolly or moving pads.

### **Felt and rubber pads**

Applying furniture pads to the feet of furniture helps cushion contact points. Furniture pads can be found at local hardware stores. Felt pads slide easily across the floor, making them ideal for dining chairs and other pieces that move with use. Rubber pads will help furniture stay in place and are perfect for larger pieces, like sofas and loveseats.

### **Area rugs and rug pads**

Using an are rug under furniture is another way to protect your floor from scratches and scuff marks. A rug pad under the area rug will provide extra cushion and added protection.

\* Replaceable Part