

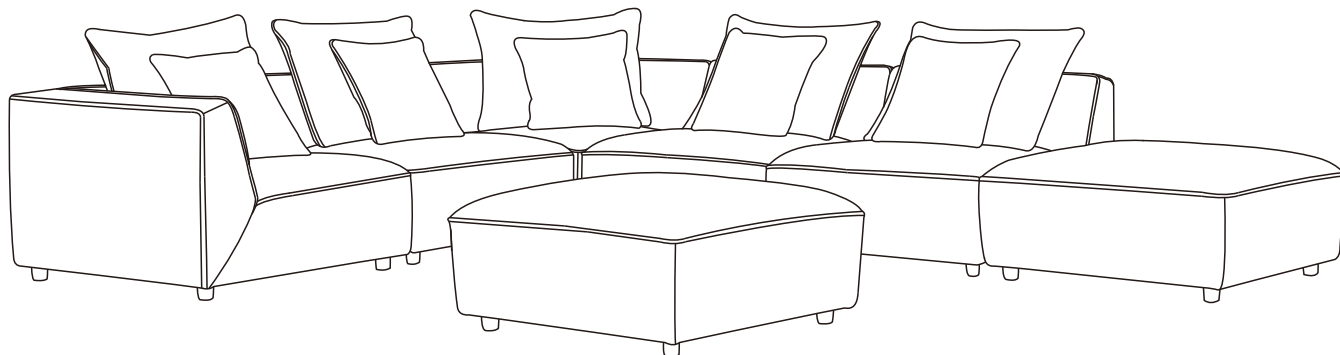

Parker Living
A Division of Parker House

Assembly Instructions Recess Modular Sectional



BEFORE ASSEMBLY



Thank you for purchasing this quality product. This product has been designed for easy assembly and constructed for durability. Please take the time to read and follow the assembly instructions carefully.

PART LIST

When unpacking, please be careful not to discard any parts with the packaging. Before continuing, please make sure you have the following parts:

Item# SREC#955-RPBL

Description# Corner Chair incl(1)back pillow & (1)toss pillow

HARDWARE LIST			
Part	Description	Sketch	Qty
A	Plastic leg		4 PCS
B	Flat Washer		4 PCS

Step 1

Please lay the item on its back on a soft, clean floor. Open the flap in the lining and remove the red package containing the four plastic legs and washers. Install as shown below.

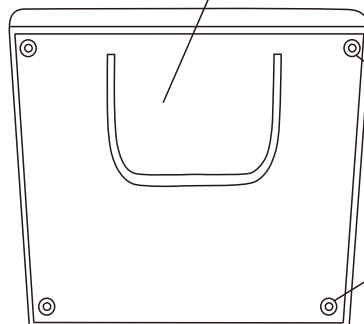
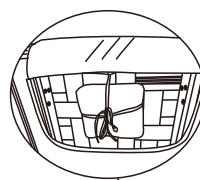
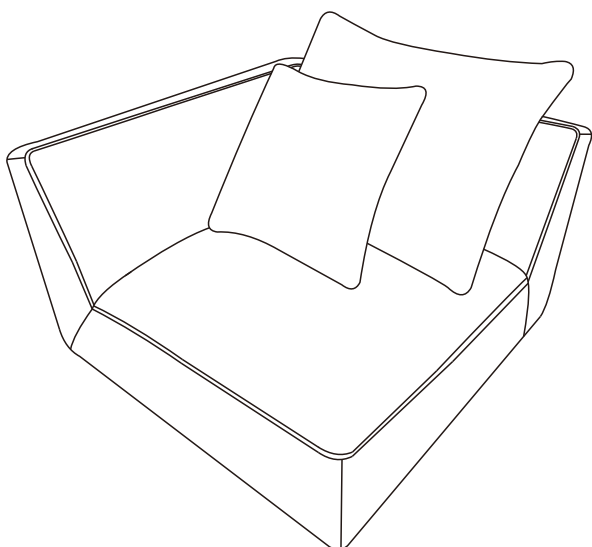

 Ax4

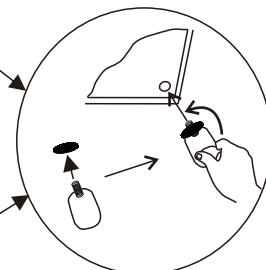

 Bx4



PART LIST

When unpacking, please be careful not to discard any parts with the packaging. Before continuing, please make sure you have the following parts:

Item# SREC#910-RPBL
 Description# Armless Chair incl(1)back pillow & (1)toss pillow

HARDWARE LIST			
Part	Description	Sketch	Qty
A	Plastic leg		4 PCS
B	Flat Washer		4 PCS

Step 2

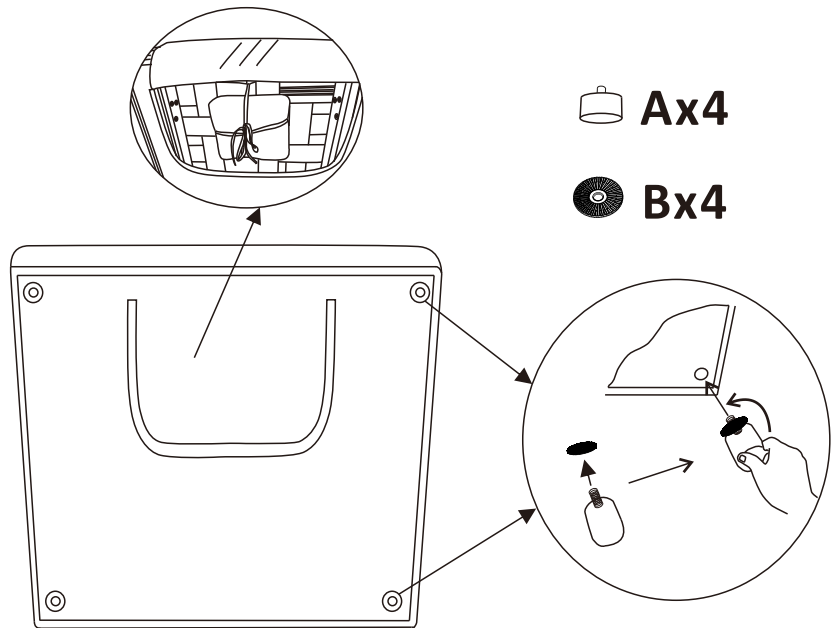
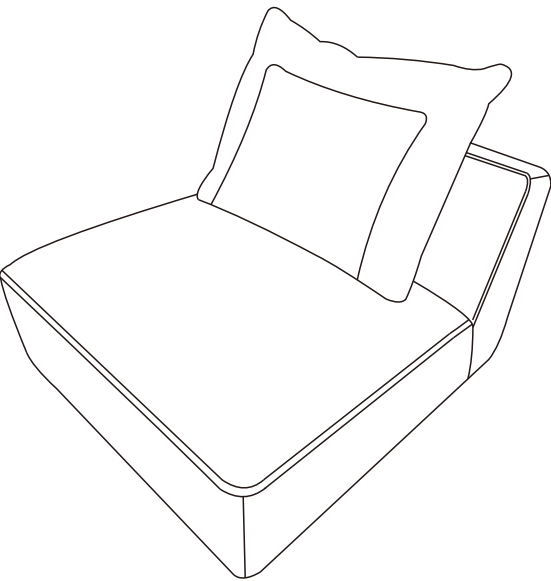

Please lay the item on its back on a soft, clean floor. Open the flap in the lining and remove the red package containing the four plastic legs and washers. Install as shown below.



PART LIST

When unpacking, please be careful not to discard any parts with the packaging. Before continuing, please make sure you have the following parts:

Item# SREC#900-RPBL
 Description# Ottoman with casters

HARDWARE LIST			
Part	Description	Sketch	Qty
A	Caster		4 PCS
B	Wrench		1 PCS

Step 3

Please lay the item on its back on a soft, clean floor. Open the flap in the lining and remove the red package containing the four casters and one wrench. Install as shown below.

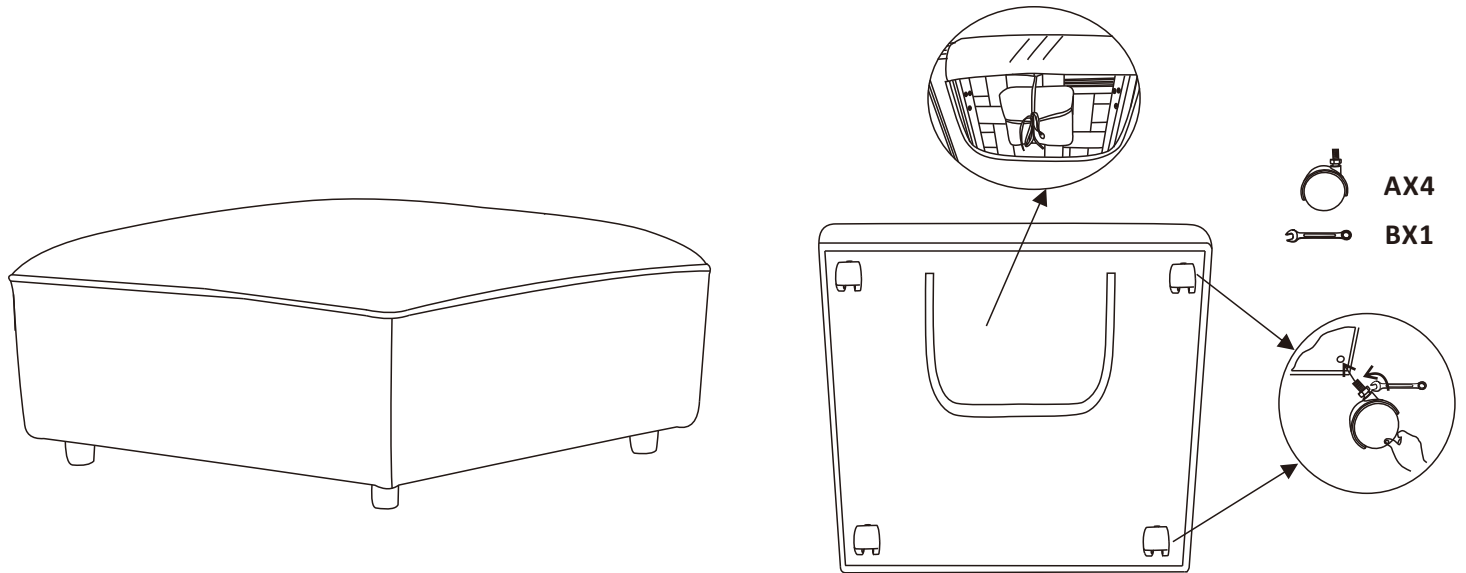

Step 4

Your items are now ready to be placed together in any configuration you choose.

Note: Each Corner Chair and Armless Chair includes one back pillow and one self pillow.

