













Assembly Instruction

Item NO:PRO#460H/461D

NO	Description	Sketch	QTY	NO	Description	Sketch	QTY
A	Allen Wrench 4mm		1	N	Wire buckle		2
B	Touch up Pen		2	O	Screw M6*3/8"		2
C	Flat Washer Ø1/4**16mm		13				
D	Lock Washer Ø1/4"		13				
E	Connector Bolt Ø1/4**1-1/4"		9				
F	Connector Bolt Ø1/4**1"		4				
G	Connector Bolt Ø1/4**1"		2				
H	Connector Cap Ø1/4**5/8"		2				
L	Screw M6*5/8"		2				
M	Wiring Grommet		1				

Begin With assembly of WAS#461D

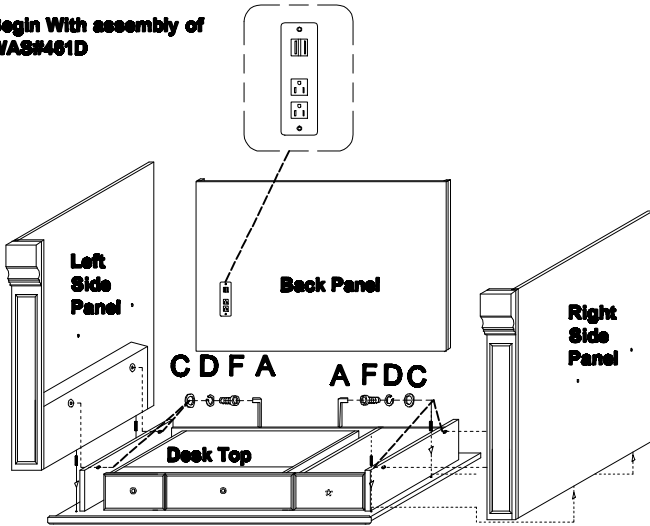

Diagram 1

1. Place Desk Top face down on soft surface, Attach Left Side Panel using Bolt F, Lock Washer D & Flat Washer C securely to the Desk Top with Allen Wrench A as shown in the illustration to the left. Repeat procedure to attach Right Side Panel to Desk Top.

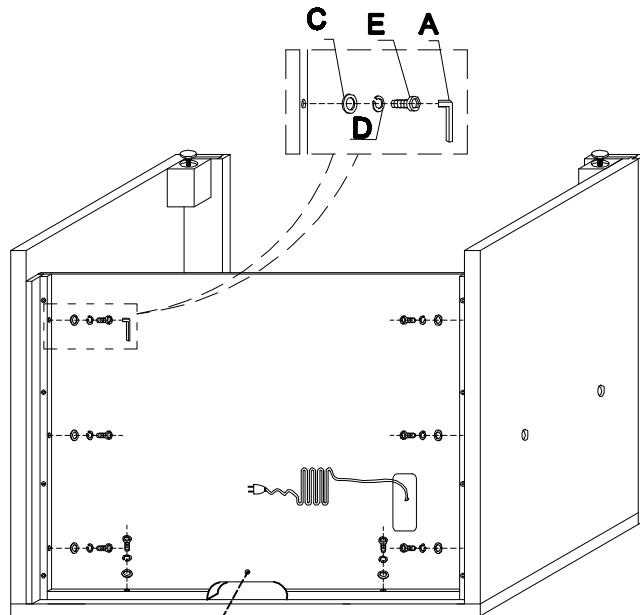

Diagram 2

2. Place Back Panel between already attached Left and Right Side Panels, securing into position by using Bolt E, Lock Washers D, & Flat Washers C with Allen Wrench A as shown in the illustration to the right.

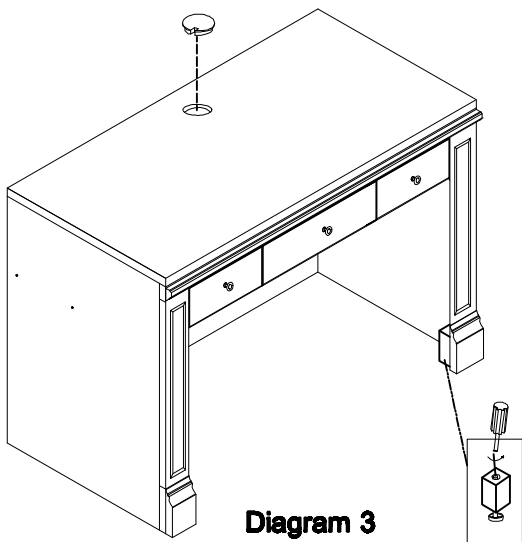

Diagram 3

Levelers

3. Carefully turn the fully assembled Desk upright Insert Wire Grommet M into wire hole on desk's top.