















Assembly Instruction

Item NO:PRO#420

NO	Description	Sketch	Q'TY	NO	Description	Sketch	Q'TY
A	Allen Wrench 4mm		1	H	Connector Cap Ø1/4"×5/8"		8
B	Allen Wrench 2.5mm		1	I	Connector Bolt Ø2.5mm		2
C	Touch up Pen		2	J	Bolt Ø1/4"×1-5/8"		2
D	Ladder Rail Coupler		1	K	Decoration Bolt Cap		2
E	Ladder Rail Finial		1	L	Shelf metal clip		8
F	Wall Strap		1	M	Allen Wrench 4mm For Electric Drill		1
G	Connector Bolt Ø1/4"×1"		8	N	Wire buckle		2
				O	Screw M6×3/8"		2

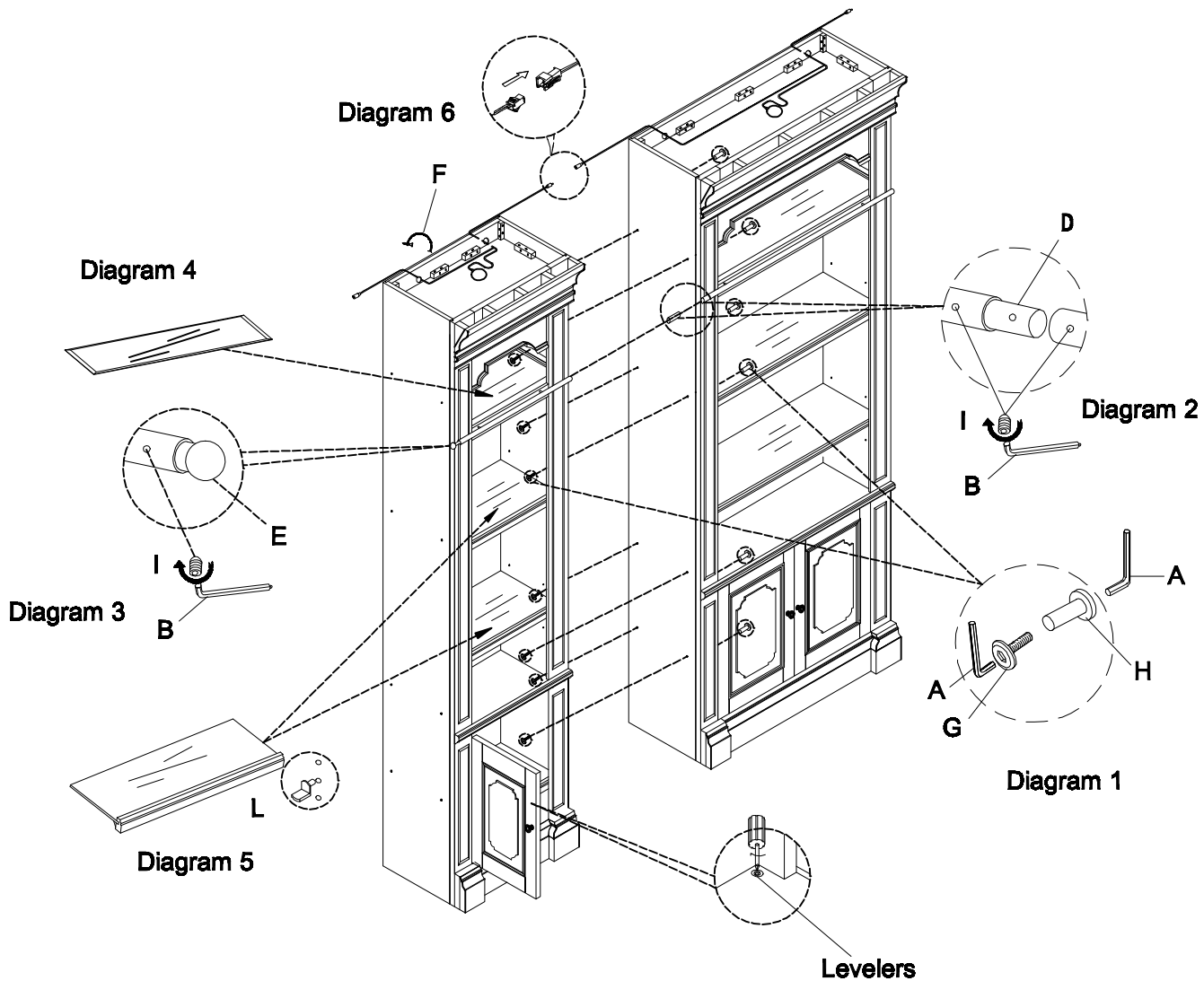

1. Align and connect cabinets with Connector Bolt G and Connector Cap H. See Diagram 1.
2. To connect ladder rails, loosen retaining screw found on each rail end, insert ladder rail coupler D about 1" on one side, and tighten. Align cabinets and push together, aligning ladder rail in the process. Tighten opposite retaining screw to secure ladder rail coupler. See Diagram 2.
3. If setting up an end piece, secure Ladder Rail Finial E to ladder rail end to complete finished look. See Diagram 3.
4. Place the glass shelf onto fix shel frame at the top level See Diagram 4
5. Place the shelf pin on the Wall cabine before put on the adjust shelf See Diagram 5

6. Connect female and male airjack light cable to properly ensure power to all LED lights. See Diagram 6.
Connect light Kit LTKIT#499 (sold separately) to right most cabinet by connecting remaining air jack cable to Control Box and securing Touch Cable to touch post located in front right corner of cabinet top. See assembly instruction sheet provided with LTKIT#499 for more details.

For your safety, once wall is fully assembled, always secure to wall Wall Strap F.