



ParkerHouse®
FURNITURE

MSPE#812PH Power Recliner

ASSEMBLY INSTRUCTIONS NOTICE DE MONTAGE

*Please keep these instructions and have the product model # and part # available when requesting a service.

*Veuillez conserver ce notice de montage et avoir en main le numéro du modèle et de la pièce pour fin de service.

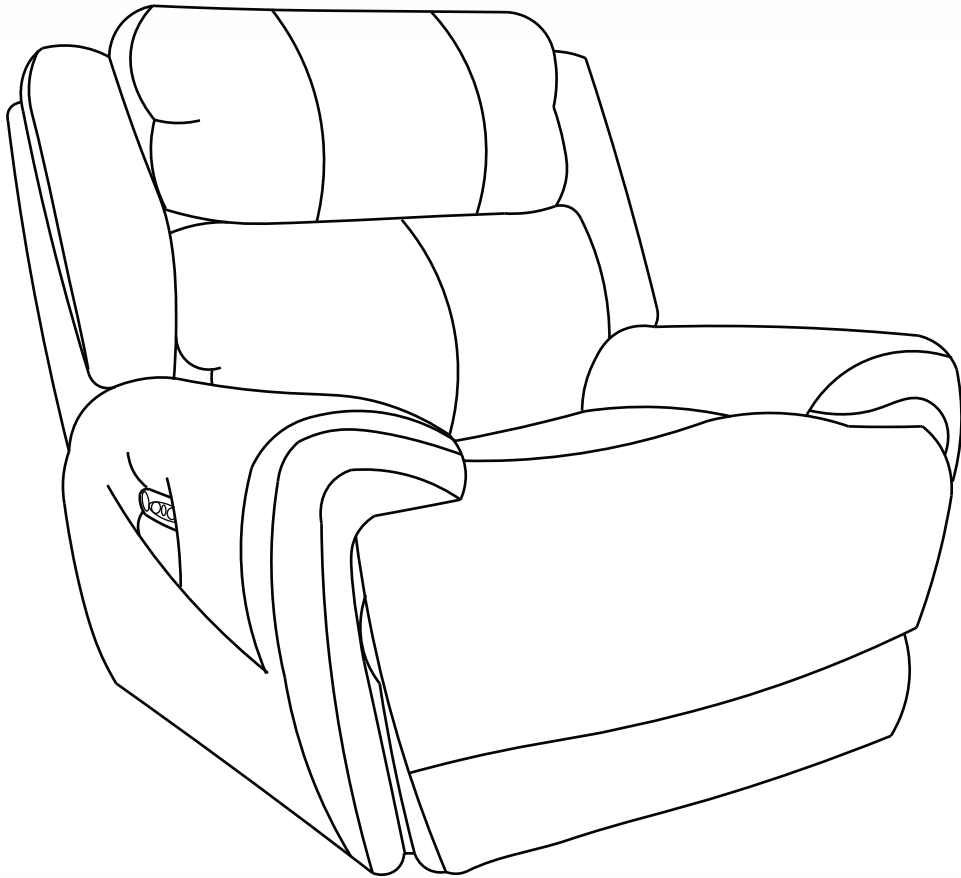

IMPORTANT NOTE

Do not use a power tool to assemble this product as it could damage the thread of the hardware and affect the solidity/durability of the product

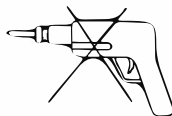

NOTE IMPORTANTE

Ne pas utiliser d'outil électrique pour assembler ce produit car cela pourra endommager le filet des quincailleries et par le fait même affecter la solidité/durabilité du produit.

MSPE#812PH

Power Recliner

A x 1

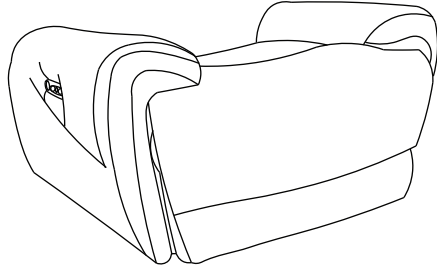

B x 1

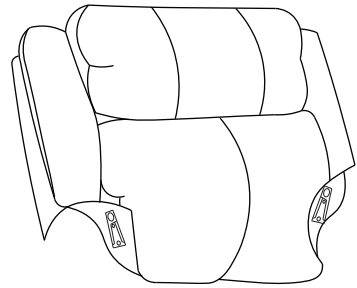

Step 1

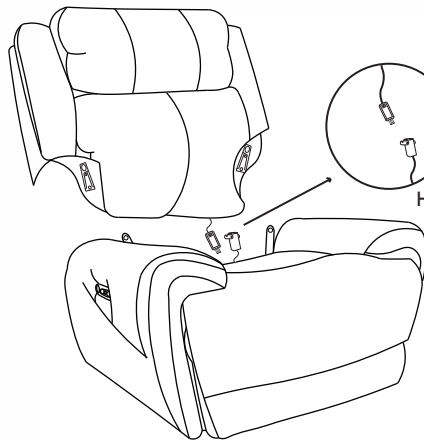
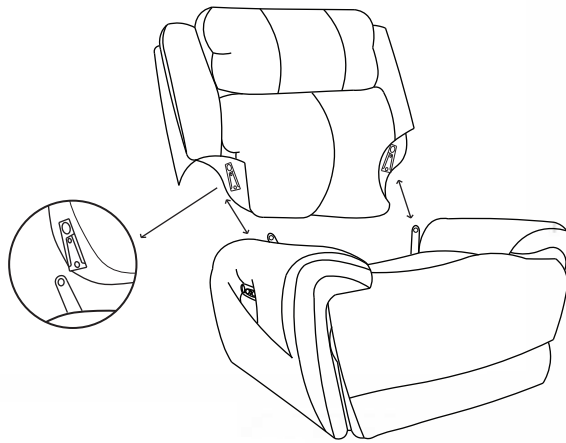

Headrest connection

Step 2

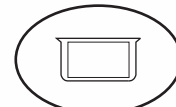

AC Power Cord

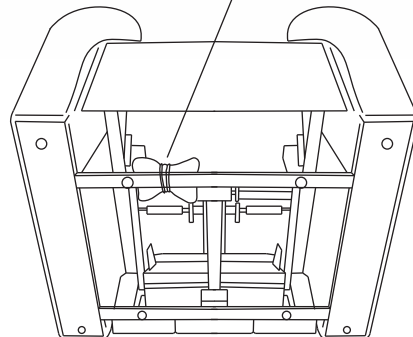

Step 3

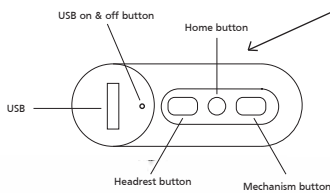
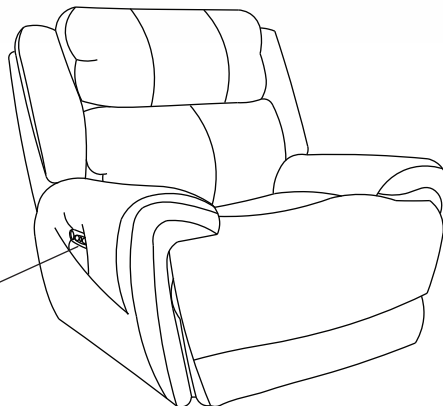

Step 4