

ASSEMBLY INSTRUCTIONS NOTICE INSTRUCCIONES DE INSTALACIÓN

*Please keep these instructions and have the product model# and part# available when requesting a service.

*Conserve estas instrucciones y tenga a mano el número de modelo y el número de pieza del producto al solicitar un servicio

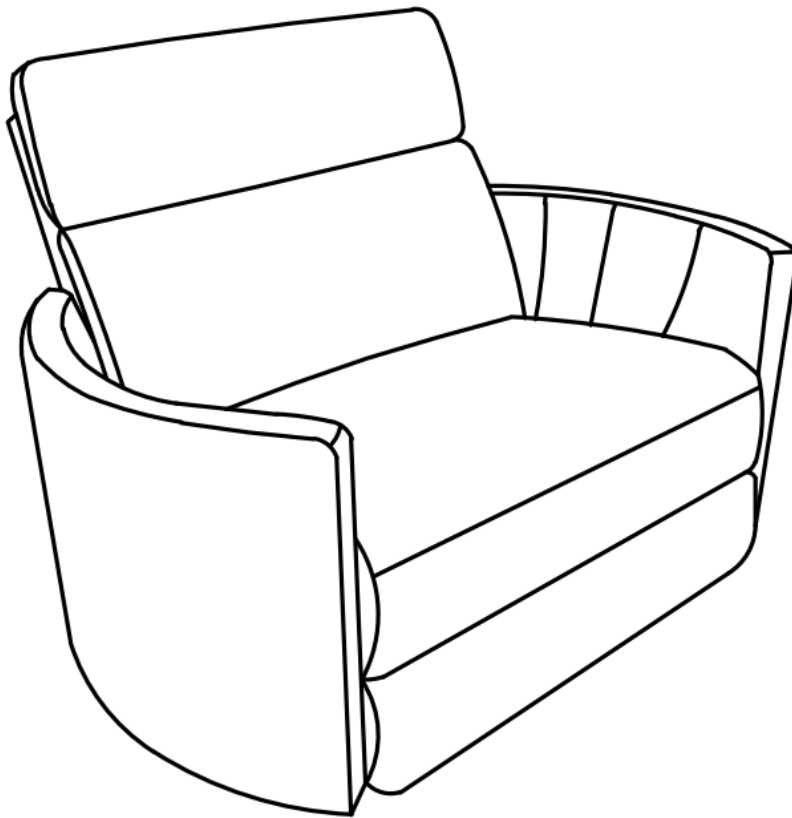

IMPORTANT NOTE

Do not use a power tool to assemble this product as it could damage the thread of the hardware.

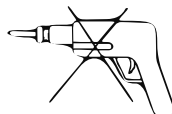

NOTA IMPORTANTE

No utilice una herramienta eléctrica para ensamblar este producto, ya que podría dañar la rosca del hardware.

A x 1

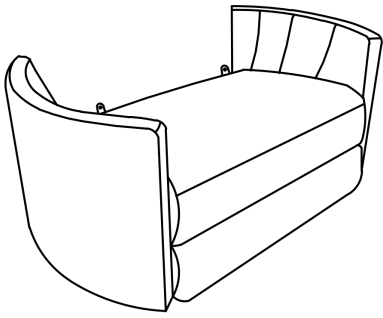

B x 1

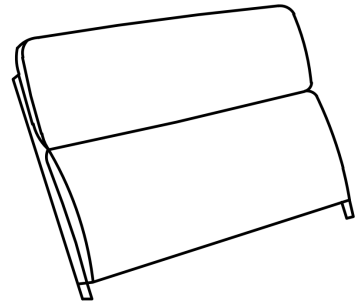

C x 1

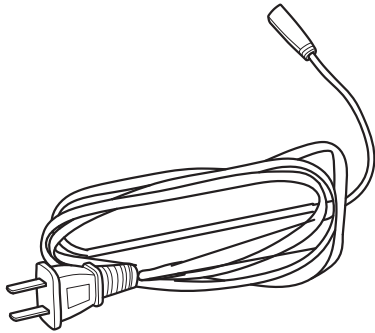

D x 2

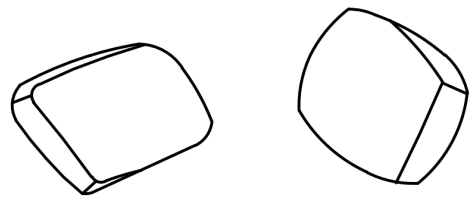

PILLOW

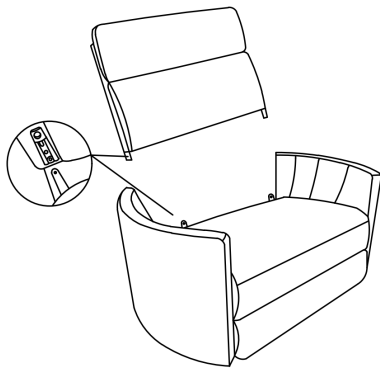

Step 1

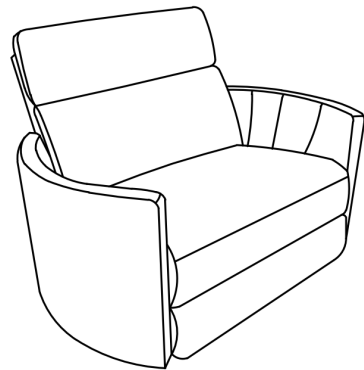

Step 2

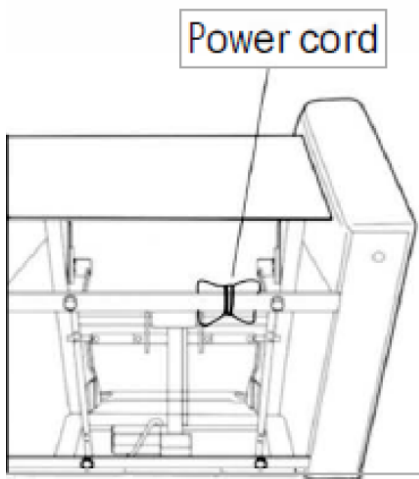

Step 3

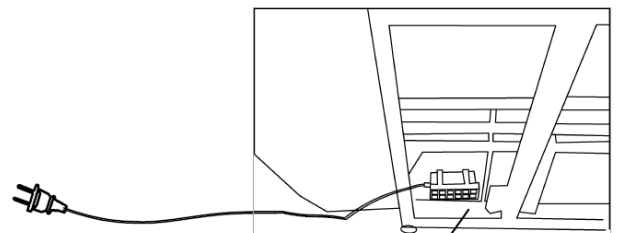

Connect the power cord and power supply

Step 4

49901104

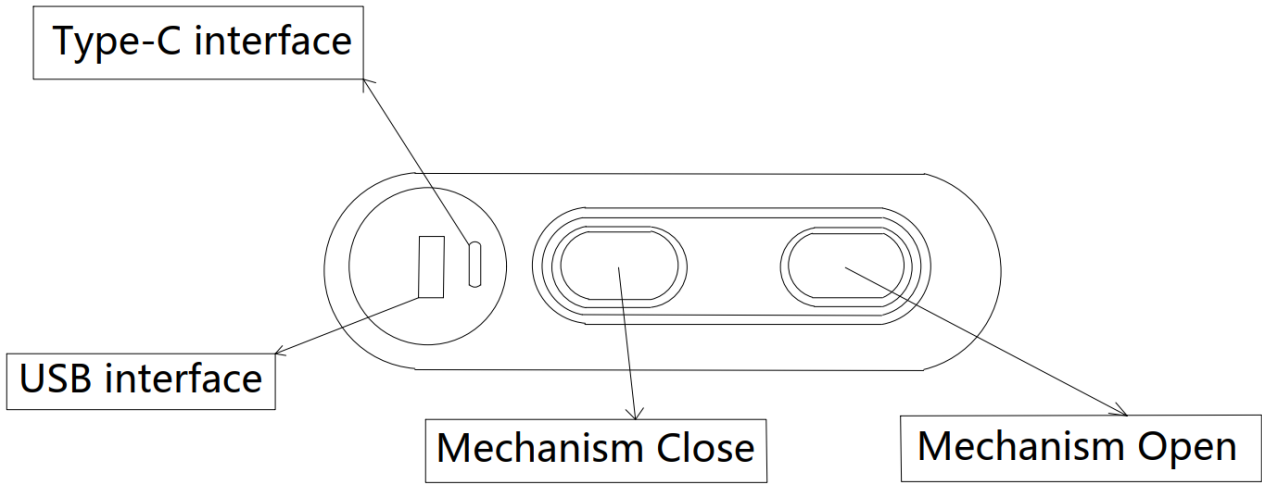

Step 5