



Parker Living®  
A Division of Parker House

# EMPIRE COLLECTION

MEMP-PACKA(H)  
Power Sectional

## ASSEMBLY INSTRUCTIONS NOTICE DE MONTAGE

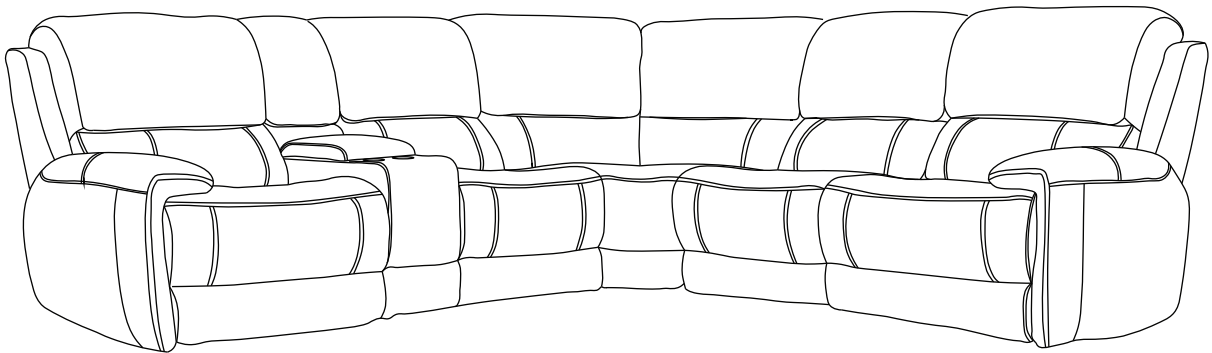

MEMP#811LPH

**x1**

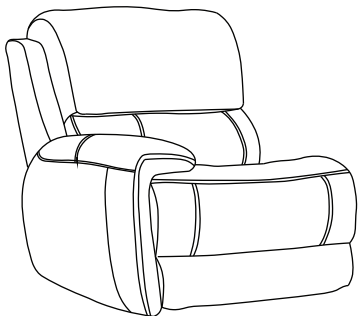

MEMP#811RPH

**x1**

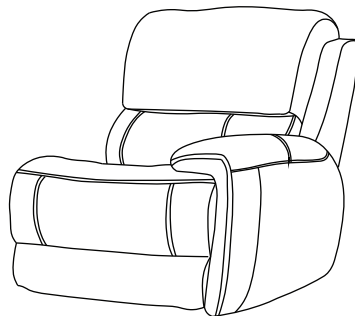

MEMP#860

**x1**

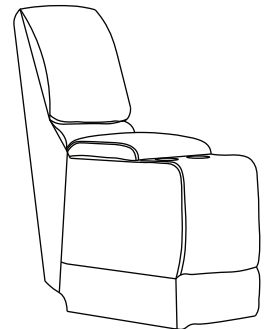

MEMP#810P

**x1**

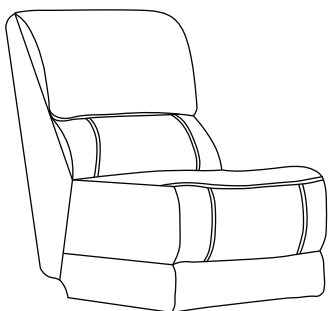

MEMP#840

**x1**

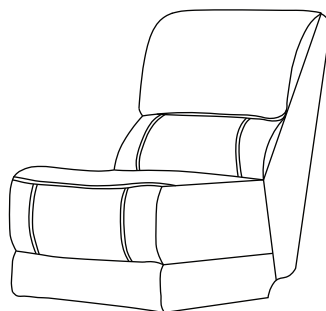

MEMP#850

**x1**

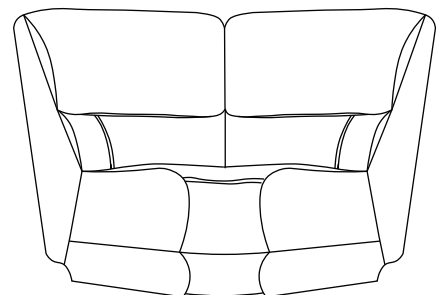

# EMPIRE COLLECTION MEMP-PACKA(H)

**Step 1** Combine all back pieces to the base.

MEMP#811LPH

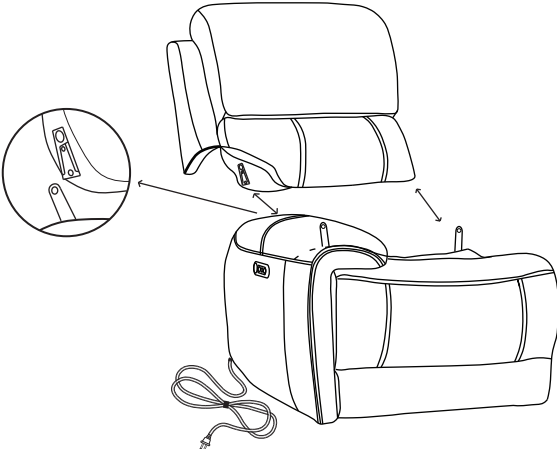

MEMP#811RPH

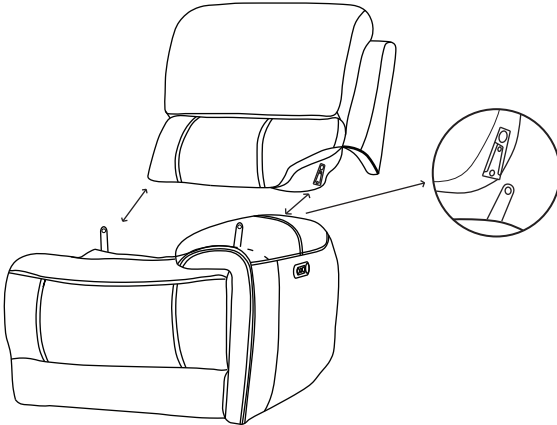

MEMP#810P

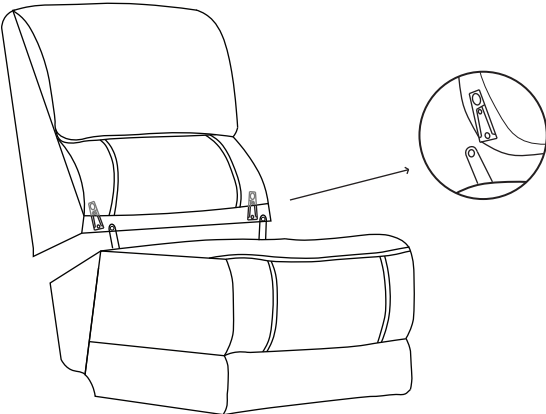

MEMP#840

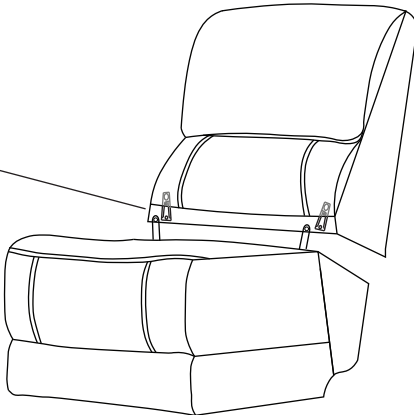

MEMP#850

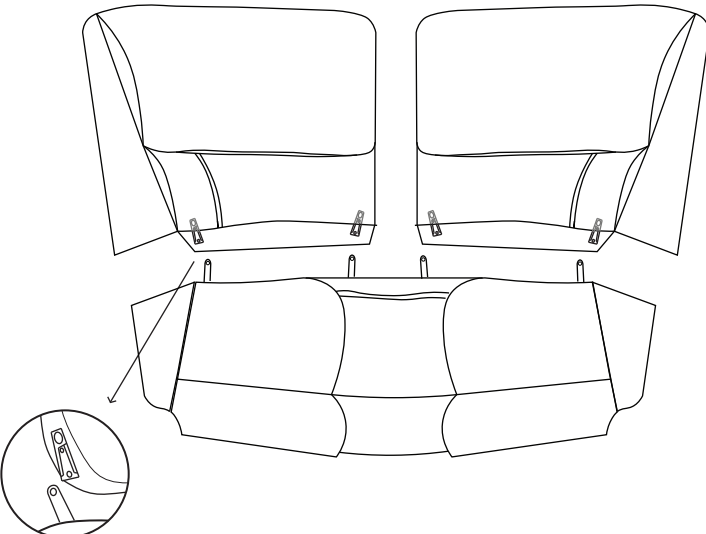

MEMP#860

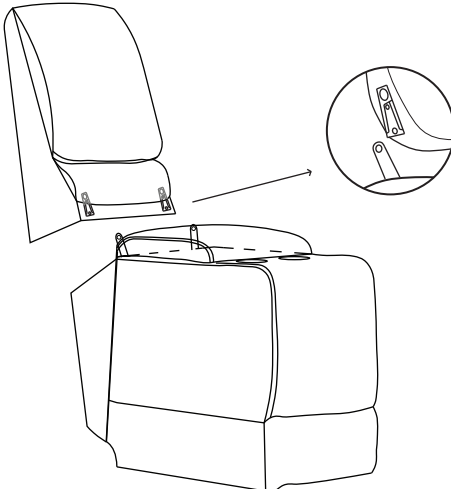

# EMPIRE COLLECTION MEMP-PACKA(H)

## Step 2

Headrest connection

MEMP#811LPH

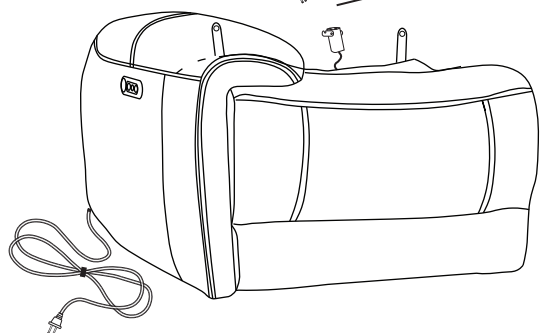
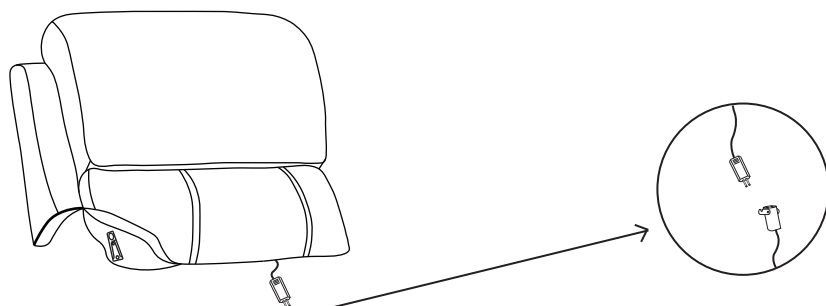

MEMP#811RPH

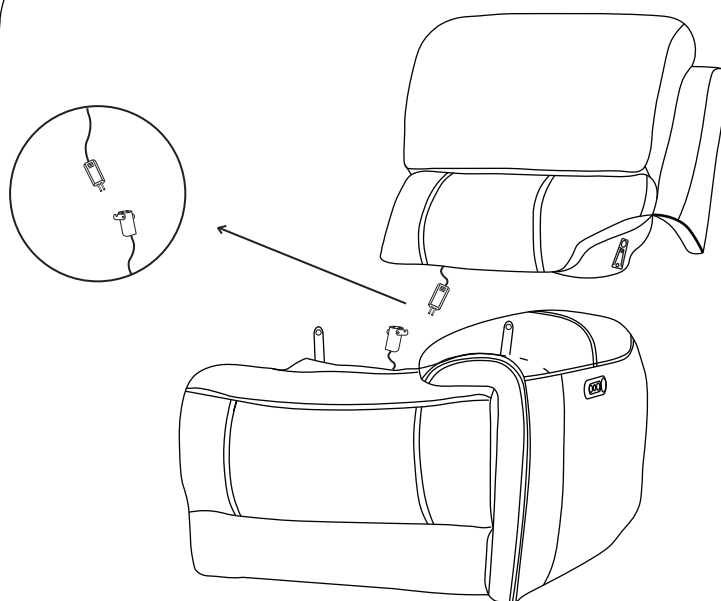

MEMP#810P

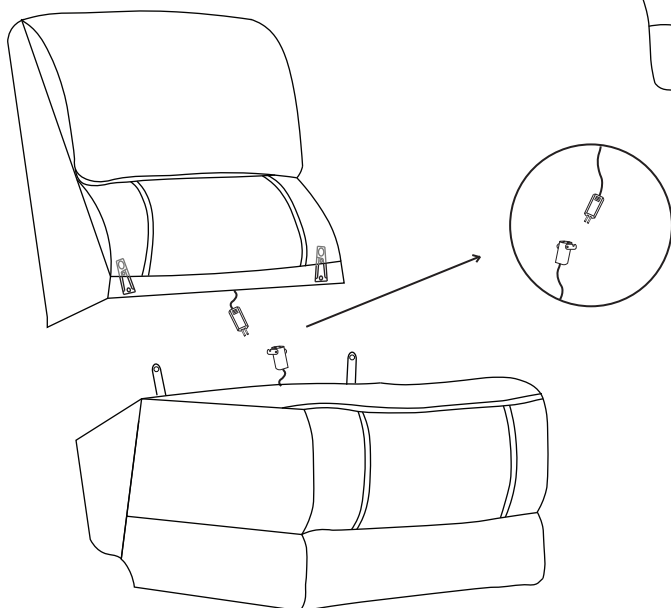

# EMPIRE COLLECTION MEMP-PACKA(H)

## Step 3

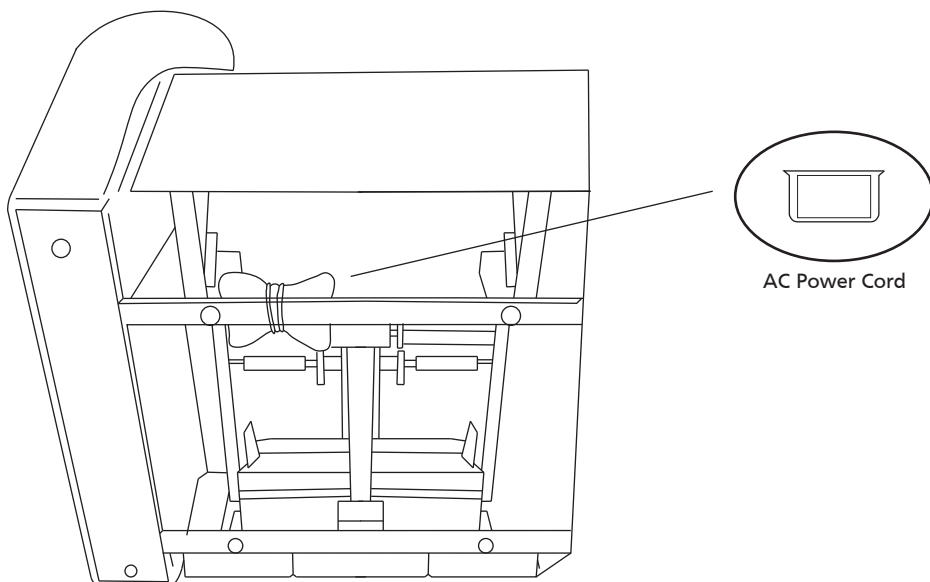

## Step 4

Attach each piece of the sectional, from left to right

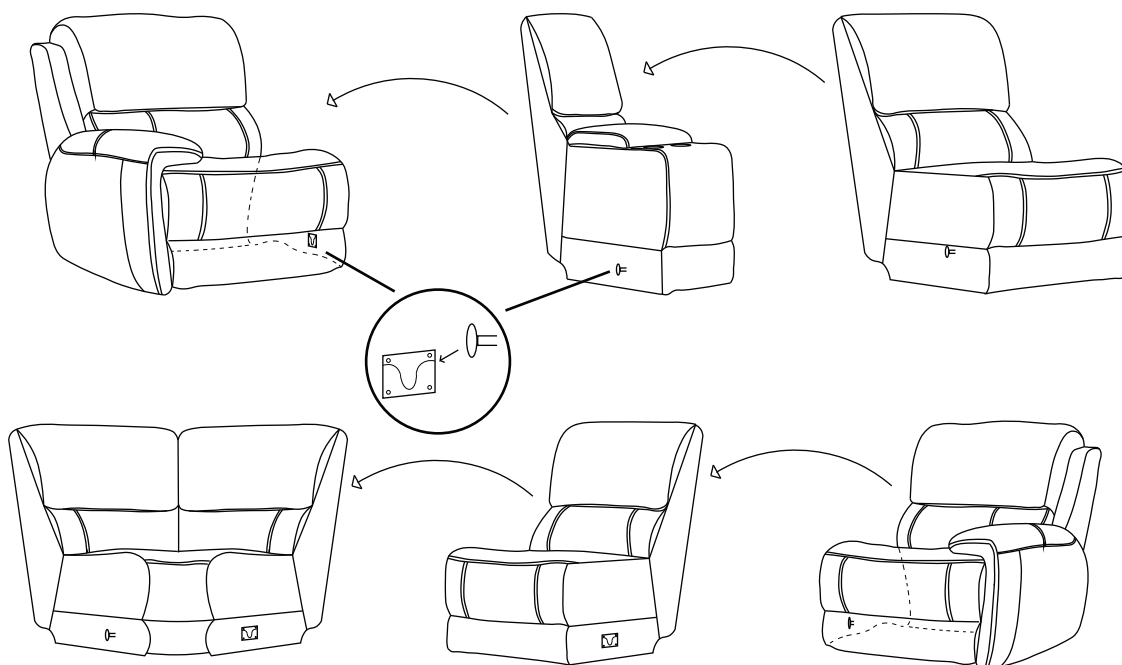

# EMPIRE COLLECTION MEMP-PACKA(H)

Step 5

Complete

