

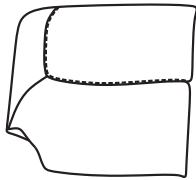





COLOSSUS COLLECTION

Check that you have all the component parts and familiarize yourself with each part before proceeding.
Verifique que tenga todos los componentes y familiarícese con cada parte antes de continuar.

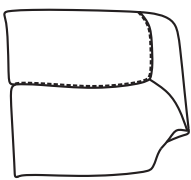
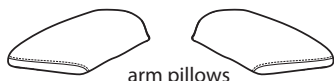
 <p>Left Back Cushion Cojín trasero izquierdo</p> <p>1</p>	 <p>console back cushion</p> <p>2</p>	 <p>Right Back Cushion Cojín trasero derecho</p> <p>3</p>
 <p>arm pillows almohadas de brazo</p>  <p>star bolt handles</p>  <p>threaded bolts</p> <p>4</p>	 <p>a = left wing cushion cojín del ala izquierda</p> <p>b = right wing cushion cojín del ala derecha</p> <p>5</p>	 <p>power cord cable de alimentación</p> <p>6</p>

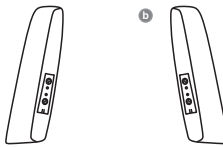
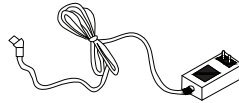
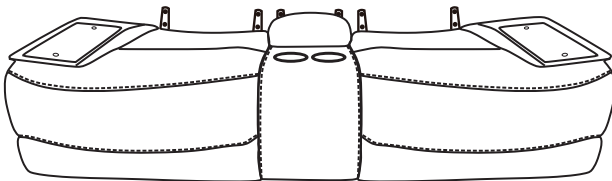
<p>PARTS LIST Please lay out all parts prior to assembly. Read instructions prior to assembly.</p> <p>LISTA DE PARTES Por favor despliegue todas las partes antes de ensamblar. Lea las instrucciones antes de ensamblar.</p>	 <p>Seat box Cojín de asiento</p> <p>7</p>
---	--

1

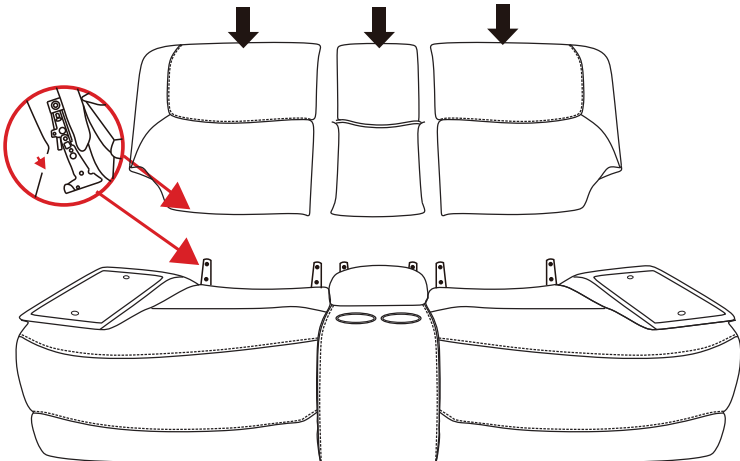

Metal lock
Cierre de metal

Fitting the Unit:
Note: It would be helpful to ask someone to assist for this step.

Insert the back rest onto seat cushion. Carefully align the two side metal locks. Engage the metal locks and push down to fit. You should hear them lock into position.

2

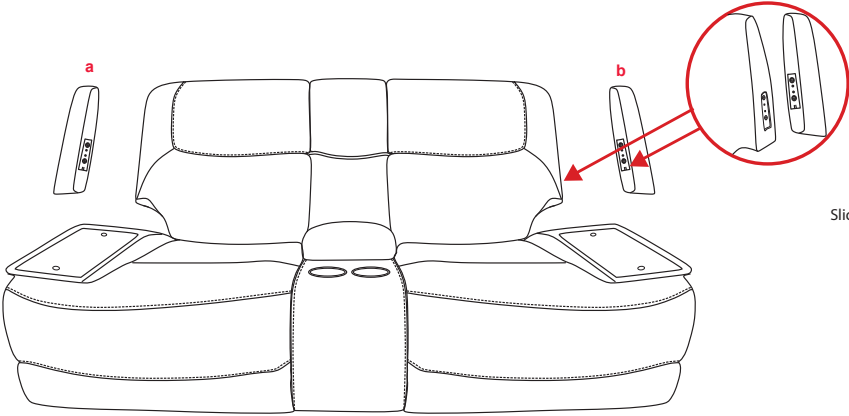

Slide wing cushions downward onto side of back cushion.

3

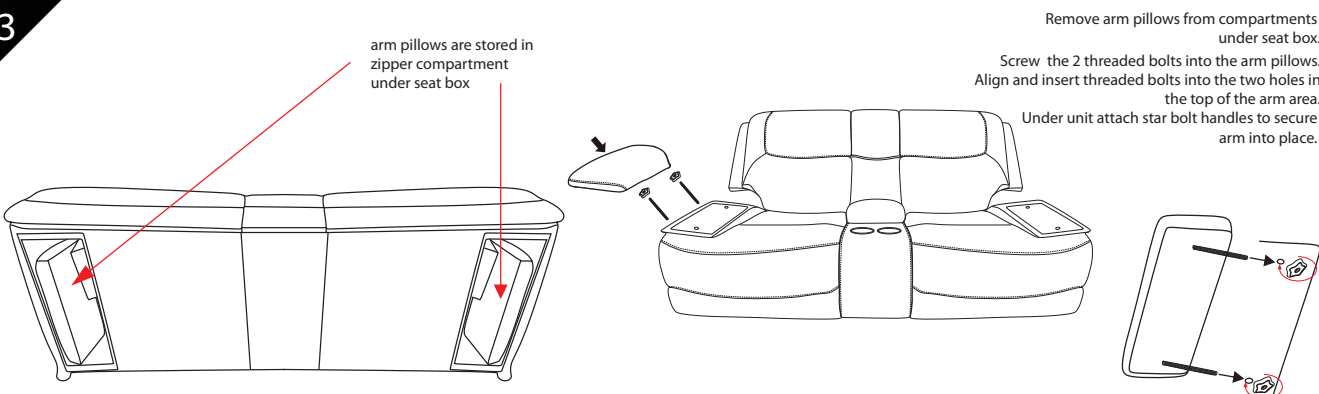

Remove arm pillows from compartments under seat box.

Screw the 2 threaded bolts into the arm pillows. Align and insert threaded bolts into the two holes in the top of the arm area. Under unit attach star bolt handles to secure arm into place.

arm pillows are stored in zipper compartment under seat box



4

Connecting power cord / Conexión del cable de alimentación

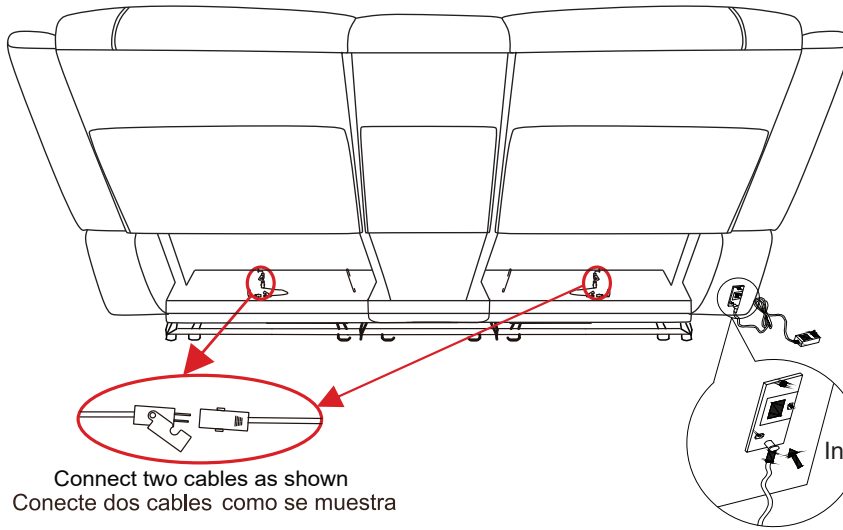

Connect two cables as shown
Conecte dos cables como se muestra

*Power cord is packed and tied under unit onto mechanism in red bag.

Insert AC plug into wall.

Insert power cord into port behind unit.

5

Final assembly as shown in the figure.

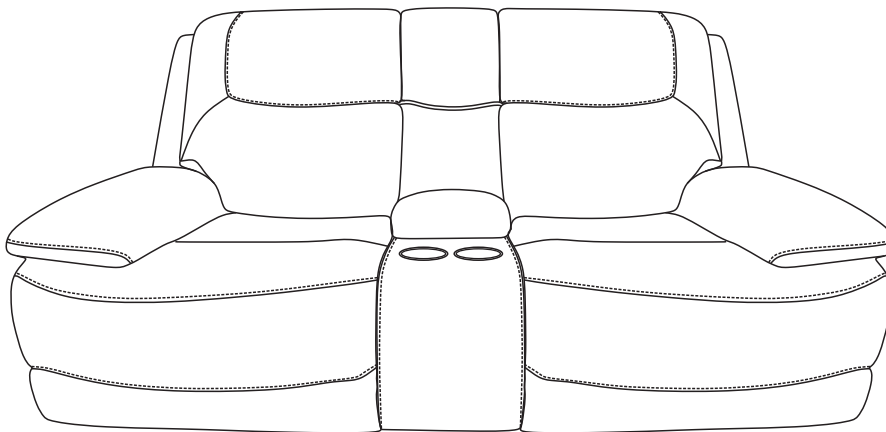

Locate the Velcro on the flap of the Back Cushions onto the back of Seat Cushions.
Ubique el Velcro en la solapa de los cojines traseros en la parte trasera de los cojines del asiento.



Features intergrated USB charger with Intelliswitch technology that automatically senses and turns off its power draw when nothing is plugged in.



CAUTION: DO NOT ALLOW CHILDREN TO PLAY ON THIS MECHANIZED FURNITURE OR OPERATE MECHANISM. LARGEST FOLDS DOWN ON CLOSING SO THAT A CHILD COULD NOT POSSIBLY BE INJURED. ALWAYS LEAVE IN AN UPRIGHT AND CLOSED POSITION. KEEP HANDS AND FEET CLEAR OF MECHANISM. ONLY OCCUPANT SHOULD OPERATE.

*to avoid any risk of suffocation to animals or children dispose of the plastic bags immediately.
*as with all surfaces clean with a damp cloth, leather can be conditioned (test conditioner on a back area before applying on visible areas). Do not use bleach or abrasive products.
*Fitting: From time to time pleasure ensure ther are no loose screws on the product.